



ACADEMIC YEAR 2021 - 2022

SR NO	NAME OF THE PATENTOR	PATENT NUMBER	TITLE OF THE PATENT/COPYRIGHT
1	AAKASH BIMAL DESAI, DEVARSH PARIMAL JOSHI	357854-001	RAIL COACH DOOR FOOT STEP
2	YOGIRAJ BRAHMBHATT, SHACHI KARAN JOSHI, HARDIKA MENGHANI	353760-001	MOBILE KICKSTAND COVER WITH ATTACHED EJECTOR PIN
3	JENISH BHARATBHAI PATEL, AMIT KAUSHIK SHAH	353741-001	INDUSTRIAL ROBOT
4	HIMANI MITTAL, HARSH AGARWAL, SWETA MITTAL	357856-001	VEGETABLE PEELER
5	HARESH RAMANLAL PARMAR	357857-001	TWO WHEELER'S DOUBLE STAND
6	MANAN PATHAK, JAY PATEL, SAGAR SONI	360075-001	SMART PLASTIC WASTE MANAGEMENT SYSTEM
7	MANAN PATHAK, JAY PATEL, SAGAR SONI	357863-001	AUTOMATIC SOLAR PANEL DUST CLEANING SYSTEM
8	DR. MAULIK JOSHI, MRS . PAYAL DESAI	357858-001	ZIP MASK
9	DR. SATVIK KHARA, PROF. BHARGAV MODI, PROF. HEMAL PATEL, PROF.HIMANSHU PRAJAPATI	357859-001	BMM WALKING STICK WITH UMBRELLA
10	MR. MOHAMMAD IMRAN, MR. MITESHKUMAR PATEL	357860-001	WASTE WATER DISPOSAL DEVICE
11	MR.KEVAL VIPULKUMAR BHAVSAR, MR.JAIMIN ALKESHKUMAR PANCHAL	357862-001	CLOTH HANGER FOR DOORS
12	YASH MANOJ SAGAR, KEVAL VIPULKUMAR BHAVSAR, UMANG VIJAYKUMAR PARMAR	360067-001	FOOD FEEDING DEVICE FOR BIRDS
13	DEVANSH SHAILESHBHAI SHAH, KEVAL VIPULKUMAR BHAVSAR, UMANG VIJAYKUMAR PARMAR	360068-001	PORTABLE MOBILE PHONE HOLDER WITH WRITING DESK
14	KEVAL VIPULKUMAR BHAVSAR, DEVANSH SHAILESHBHAI SHAH, SMIT JITENDRABHAI PANCHASARA, UMANG VIJAYKUMAR PARMAR	360073-001	MULTI DIMENSION CUP HOLDER
15	NIHAR V. RAVAL, VEDKUMAR N. PATEL	353744-001	WALL MOUNTED ACTIVE SOLAR TRACKER
16	MIT SHAH, RIPEN SHAH	348962-001	FRONT KNUCKLE



SR NO	NAME OF THE PATENTOR	PATENT NUMBER	TITLE OF THE PATENT/COPYRIGHT
17	ANVESH JHAVERI, ISHAN THAKAR	348964-001	REAR KNUCKLE
18	ASIFALI SHEKH, NEJAL PATEL	348968-001	REAR WHEEL HUB
19	VIRAT DHOLAKIYA, RIPEN SHAH	348969-001	ROLLCAGE STRUCTURE
20	PRATIK GUPTA, ISHAN THAKAR	348966-001	BRAKE DISC
21	MARUT PATEL, NEJAL PATEL	349843-001	FRONT KNUCKLE
22	RIPEN SHAH, MIT SHAH	349852-001	ENGINE MOUNTING
23	RIPEN SHAH, MIT SHAH	349853-001	FRONT HUB
24	VIRAT DHOLAKIYA, ISHAN THAKAR	350660-001	REAR BRAKE DISC
25	RIPEN SHAH, MIT SHAH	350650-001	ENGINE MOUNTING
26	HIMANSHU VAGHELA, ISHAN THAKAR	350651-001	FRONT DISC BRAKE
27	BHAVDEEP TRIVEDI, VIRAT DHOLAKIYA	348961-001	DRIVE AXLE
28	RIPEN SHAH, MIT SHAH	350652-001	FRONT HUB
29	NIHAR RAVAL, NEJAL PATEL	350657-001	REAR WHEEL KNUCKLE
30	ASHISH BIST, NEJAL PATEL	350658-001	ROLLCAGE STRUCTURE
31	VENISH SUTHAR, ISHAN THAKAR	350659-001	STEERING WHEEL
32	DHRUVIN PATEL, DEVANSH SHAH, RUSHIL SHAH	353752-001	GEAR BOX FOR CONSTRAINED GEAR TRAIN OF PORTAL AXEL SYSTEM
33	KEVAL VIPULKUMAR BHAVSAR, JAIMIN ALKESHKUMAR PANCHAL, DHARMIK PRAVINBHAI GOHEL, JAY HITENDRAKUMAR KHATRI	353737-001	BODY AND CLOTH DRYER
34	KEVAL VIPULKUMAR BHAVSAR, JAIMIN ALKESHKUMAR PANCHAL, DHARMIK	353739-001	CONVEYOR MACHINES

Established by Gujarat Private Universities Act 200G



SR NO	NAME OF THE PATENTOR	PATENT NUMBER	TITLE OF THE PATENT/COPYRIGHT
	PRAVINBHAI GOHEL, HITESHKUMAR NATVARLAL PRAJAPATI		
35	MANSI JITENDRABHAI DAVE, JENICE PRAKASHKUMAR BHAVSAR	356367-001	SIDE VIEW MIRROR FOR TWO WHEELER YEHICLE
36	MANAN PATHAK, JAY PATEL, SAGAR SONI	356374-001	SILVER SOLAR TREE
37	KRUTARTH TRIVEDI, VIRAT DHOLAKIYA	349847-001	ROLLCAGE STRUCTURE
38	YASH MOHNOT, VIRAT DHOLAKIYA	350648-001	ROLLCAGE STRUCTURE
39	VATSAL SONI, VIRAT DHOLAKIYA	350654-001	RACK AND PINION CASING
40	VIRAT DHOLAKIYA, VENISH SUTHAR	350655-001	REAR BRAKE DISC
41	PRAKRUTI MUKUL, VIRAT DHOLAKIYA	350656-001	REAR HUB INTEGRATED WITH CV
42	KEVAL KELAWALA, SHIVAM JANI	356371-001	MASK EAR PROTECTOR – MASKER
43	KEVAL KELAWALA, SHIVAM JANI	356372-001	HANDLE
44	VIRAJ PANCHAL, BHAVDEEP TRIVEDI	348967-001	FRONT HUB
45	RUTVIK SUTHAR, VENISH SUTHAR	348965-001	STEERING CASING
46	MANISH JAYSAWAL, VENISH SUTHAR	349844-001	GEARBOX CASING
47	ANIKET PATEL, VENISH SUTHAR	349854-001	FRONT KNUCKLE
48	BRIJESH VAGHELA, BHAVDEEP TRIVEDI	350646-001	REAR HUB INTEGRATED WITH CV
49	SAMARTH DHARMESHBHAI ADESARA, BHAVDEEP TRIVEDI	350653-001	FRONT KNUCKLE
50	VEDKUMAR N. PATEL, DHRUVKUMAR RAMESHBHAI PATEL	356213-001	PALLET
51	Sumit Gurbani, Mohit Singh	349846-001	Rear Knuckle
52	Kartik Iyer, Krunal Keraliya	348963-001	Gearbox Casing



ORIGINAL

No. 112405

भारत सरकार
GOVERNMENT OF INDIA
पेटेंट कार्यालय
THE PATENT OFFICE

CERTIFICATE OF REGISTRATION OF DESIGN

Design No. 357854-001
Date 03/02/2022 19:29:25
Reciprocity Date*
Country

Certified that the design of which a copy is annexed hereto has been registered as of the number and date given above in class 25-04 in respect of the application of such design to RAIL COACH DOOR FOOT STEP in the name of L.AAKASH BIMAL DESAI, SILVER OAK UNIVERSITY CAMPUS, OPP. BHAGWAT VIDYAPITH, S.G ROAD, GOTTA, AHMEDABAD – 382481 2. DEVARSH PARIMAL JOSHI, SILVER OAK UNIVERSITY CAMPUS, OPP. BHAGWAT VIDYAPITH, S.G ROAD, GOTTA, AHMEDABAD – 382481, INDIA

in pursuance of and subject to the provisions of the Designs Act, 2000 and the Designs Rules, 2001.

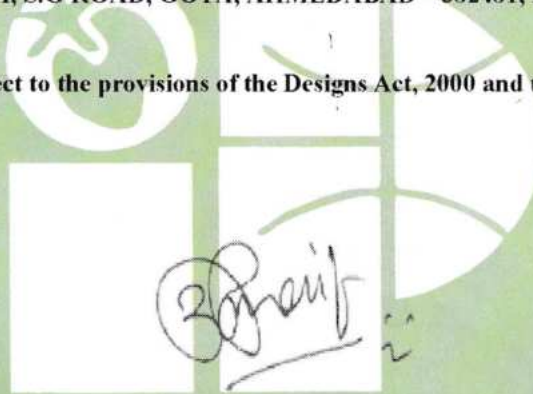

Controller General of Patents, Designs and Trade Marks

*The reciprocity date (if any) which has been allowed and the name of the country.

Copyright in the design will subsist for ten years from the date of Registration, and may under the terms of the Act and Rules, be extended for a further period of five years.

This Certificate is not for use in legal proceedings or for obtaining registration abroad

MS. DHARTI SHAH,
VERITE ASSOCIATES, 105, SCARLET GATEWAY,
NR. SPIPA ACADEMY, CORPORATE ROAD,
PRAHALADNAGR, AHMEDABAD-380015, GUJARAT,
INDIA

Date of Issue 26/04/2022 15:13:32

(REPRESENTATION SHEETS)

NAME OF THE APPLICANT
AAKASH BIMAL DESAI
DEVARSH PARIMAL JOSHI

NO. OF SHEETS - 3
SHEET NO. - 1

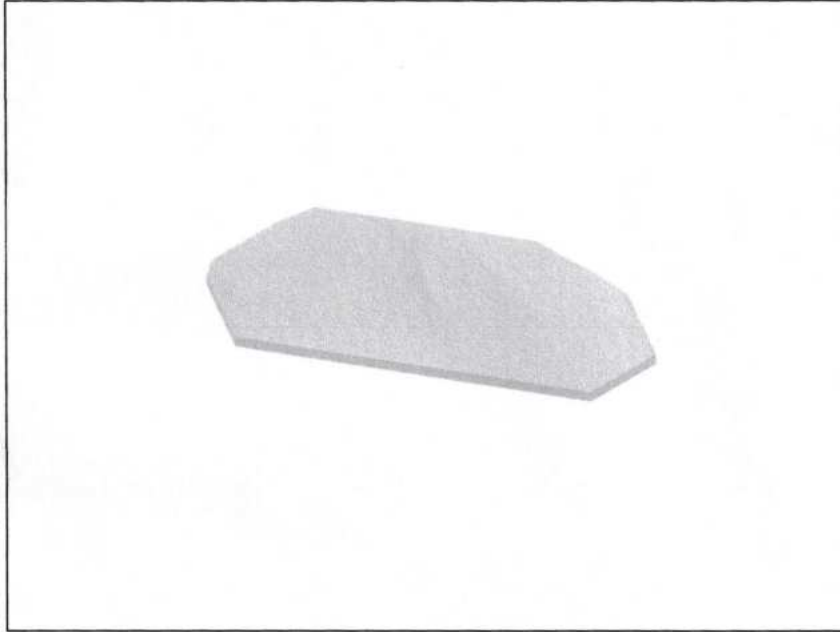

PERSPECTIVE VIEW

The novelty resides in the shape and configuration of the 'RAIL COACH DOOR FOOT STEP' as illustrated.

No claim is made by virtue of this registration in respect of any mechanical or other action of the mechanism whatever or in respect of any mode or principle of construction of the article.

No claim is made by virtue of the registration to any right to the exclusive use of the words, letters, numbers, colour, combination or Trade Marks as appearing in the representation.

357854-001

03 FEB 2022

Dated this 2nd Day of February 2022.

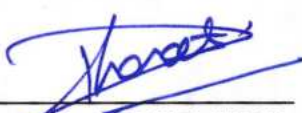
Ms. DHARTI SHAH
(Authorized Agent of the Applicant)
(IN/PA- 2590)

(REPRESENTATION SHEETS)

NAME OF THE APPLICANT
AAKASH BIMAL DESAI
DEVARSH PARIMAL JOSHI

NO. OF SHEETS - 3
SHEET NO. - 2

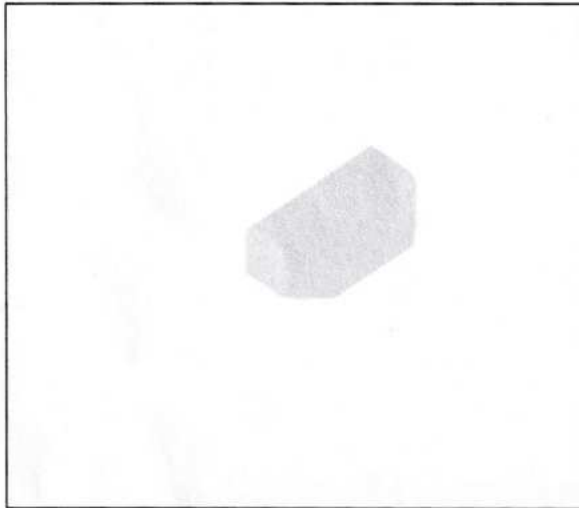

TOP VIEW

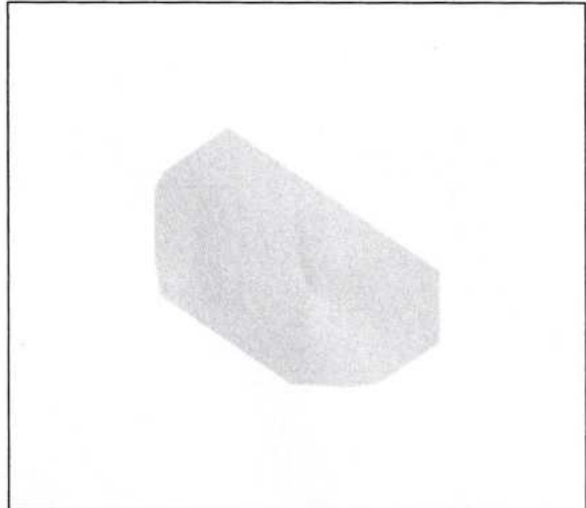

BOTTOM VIEW

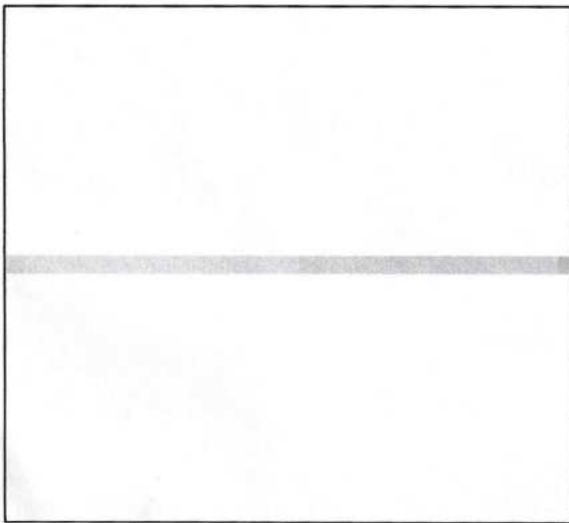

FRONT VIEW

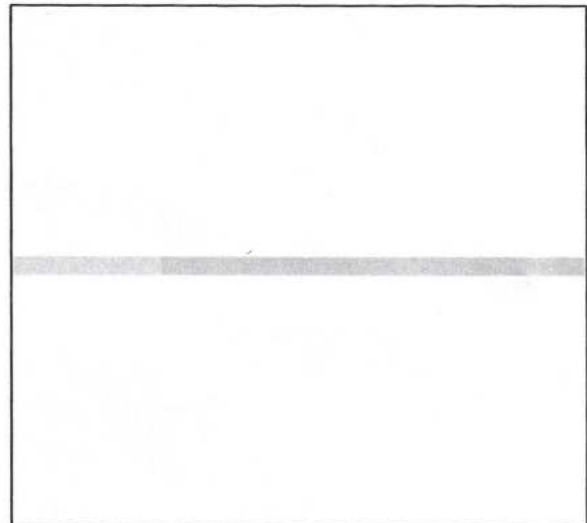

BACK VIEW

The novelty resides in the shape and configuration of the 'RAIL COACH DOOR FOOT STEP' as illustrated.

No claim is made by virtue of this registration in respect of any mechanical or other action of the mechanism whatever or in respect of any mode or principle of construction of the article.

No claim is made by virtue of the registration to any right to the exclusive use of the words, letters, numbers, colour, combination or Trade Marks as appearing in the representation.

357854-001

03 FEB 2022

Dated this 2nd Day of February 2022.

Ms. DHARTI SHAH
(Authorized Agent of the Applicant)
(IN/PA- 2590)

(REPRESENTATION SHEETS)

NAME OF THE APPLICANT
AAKASH BIMAL DESAI
DEVARSH PARIMAL JOSHI

NO. OF SHEETS - 3
SHEET NO. - 3

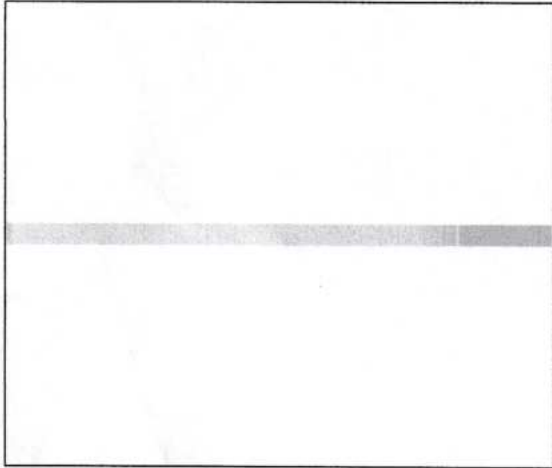

RIGHT SIDE VIEW

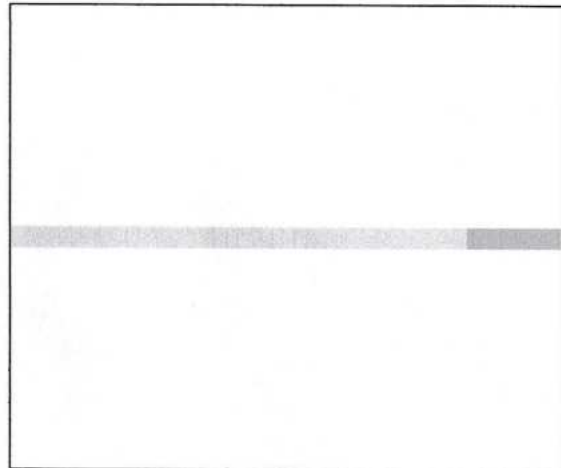

LEFT SIDE VIEW

The novelty resides in the shape and configuration of the 'RAIL COACH DOOR FOOT STEP' as illustrated.

No claim is made by virtue of this registration in respect of any mechanical or other action of the mechanism whatever or in respect of any mode or principle of construction of the article.



No claim is made by virtue of the registration to any right to the exclusive use of the words, letters, numbers, colour, combination or Trade Marks as appearing in the representation.

357854-001

03 FEB 2022

Dated this 2nd Day of February 2022.

Ms. DHARTI SHAH
(Authorized Agent of the Applicant)
(IN/PA- 2590)

DESIGN NUMBER	357842-006	
CLASS	12-11	
M/S AVON CYCLES LIMITED G. T. ROAD, LUDHIANA-141003, INDIA		
DATE OF REGISTRATION	03/02/2022	
TITLE	CYCLE	
PRIORITY NA		
DESIGN NUMBER	357854-001	
CLASS	25-04	
1.AAKASH BIMAL DESAI SILVER OAK UNIVERSITY CAMPUS, OPP. BHAGWAT VIDYAPITH, S.G ROAD, GOTA, AHMEDABAD – 382481 2. DEVARSH PARIMAL JOSHI SILVER OAK UNIVERSITY CAMPUS, OPP. BHAGWAT VIDYAPITH, S.G ROAD, GOTA, AHMEDABAD – 382481, INDIA		
DATE OF REGISTRATION	03/02/2022	
TITLE	RAIL COACH DOOR FOOT STEP	
PRIORITY NA		
DESIGN NUMBER	357858-001	
CLASS	29-02	
1.DR. MAULIK JOSHI SILVER OAK UNIVERSITY CAMPUS, OPP. BHAGWAT VIDYAPITH, S.G ROAD, GOTA, AHMEDABAD – 382481, INDIA 2. PAYAL DESAI SILVER OAK UNIVERSITY CAMPUS, OPP. BHAGWAT VIDYAPITH, S.G ROAD, GOTA, AHMEDABAD – 382421, INDIA		
DATE OF REGISTRATION	03/02/2022	
TITLE	ZIP MASK	
PRIORITY NA		



सत्यमेव जयते

भारत सरकार
GOVERNMENT OF INDIA
पेटेंट कार्यालय
THE PATENT OFFICE

ORIGINAL

No. 107451

CERTIFICATE OF REGISTRATION OF DESIGN

Design No. 353760-001
Date 26/11/2021 16:14:42
Reciprocity Date*
Country

Certified that the design of which a copy is annexed hereto has been registered as of the number and date given above in class 03-01 in respect of the application of such design to MOBILE KICKSTAND COVER WITH ATTACHED EJECTOR PIN in the name of I.YOGIRAJ BRAHMBHATT, SILVER OAK UNIVERSITY CAMPUS, OPP. BHAGWAT VIDYAPITH, S.G ROAD, GOTA, AHMEDABAD – 382481, INDIA 2. SHACHI JOSHI, SILVER OAK UNIVERSITY CAMPUS, OPP. BHAGWAT VIDYAPITH, S.G ROAD, GOTA, AHMEDABAD – 382481, INDIA 3. HARDIKA MENGHANI, SILVER OAK UNIVERSITY CAMPUS, OPP. BHAGWAT VIDYAPITH, S.G ROAD, GOTA, AHMEDABAD – 382481, INDIA

in pursuance of and subject to the provisions of the Designs Act, 2000 and the Designs Rules, 2001.

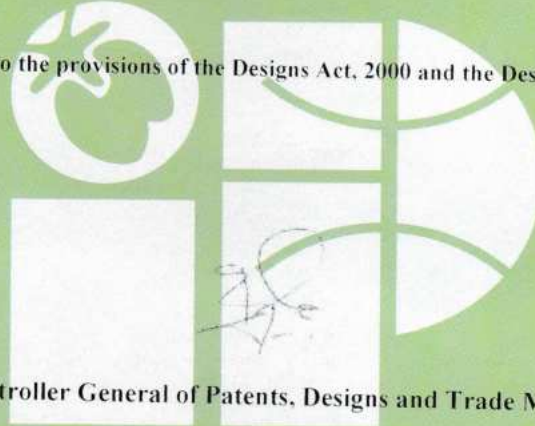

Controller General of Patents, Designs and Trade Marks

*The reciprocity date (if any) which has been allowed and the name of the country.

Copyright in the design will subsist for ten years from the date of Registration, and may under the terms of the Act and Rules, be extended for a further period of five years.

This Certificate is not for use in legal proceedings or for obtaining registration abroad.

MS. DHARTI SHAH,
VERITE ASSOCIATES, 105, SCARLET GATEWAY, NR.
SPIPA ACADEMY, CORPORATE ROAD,
PRAHALADNAGR, AHMEDABAD-380015, GUJARAT,
INDIA

INTELLECTUAL
PROPERTY INDIA
DESIGNS | TRADE MARKS
GEOGRAPHICAL INDICATIONS

Date of Issue 17/01/2022 16:06:29

(REPRESENTATION SHEETS)

NAME OF THE APPLICANT
YOGIRAJ BRAHMBHATT
SHACHI JOSHI
HARDIKA MENGHANI

NO. OF SHEETS - 3
SHEET NO. - 1

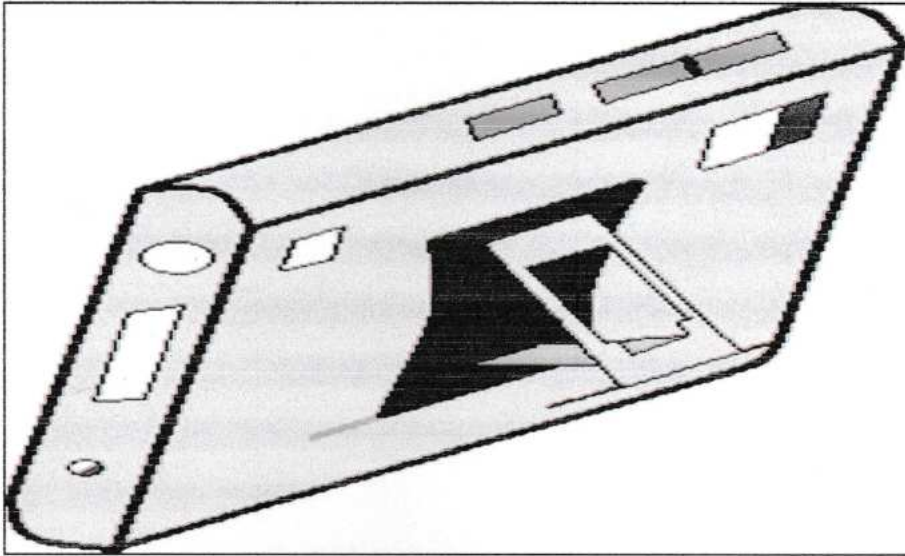

PERSPECTIVE VIEW

The novelty resides in the shape and configuration of the 'MOBILE KICKSTAND COVER WITH ATTACHED EJECTOR PIN' as illustrated.

No claim is made by virtue of this registration in respect of any mechanical or other action of the mechanism whatever or in respect of any mode or principle of construction of the article.

No claim is made by virtue of the registration to any right to the exclusive use of the words, letters, numbers, colour, combination or Trade Marks as appearing in the representation.

353760 -001

26 NOV 2021

Ms. DHARTI SHAH
(Authorized Agent of the Applicant)
(IN/PA- 2590)

(REPRESENTATION SHEETS)

NAME OF THE APPLICANT
YOGIRAJ BRAHMBHATT
SHACHI JOSHI
HARDIKA MENGHANI

NO. OF SHEETS - 3
SHEET NO. - 2



TOP VIEW



BOTTOM VIEW

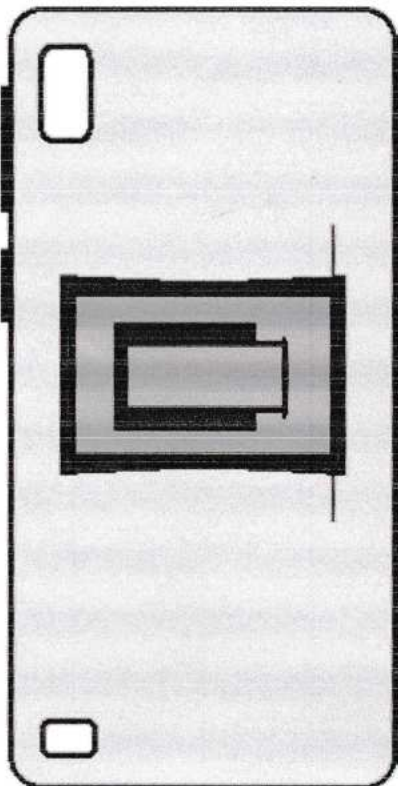

FRONT VIEW

The novelty resides in the shape and configuration of the **'MOBILE KICKSTAND COVER WITH ATTACHED EJECTOR PIN'** as illustrated.

No claim is made by virtue of this registration in respect of any mechanical or other action of the mechanism whatever or in respect of any mode or principle of construction of the article.

No claim is made by virtue of the registration to any right to the exclusive use of the words, letters, numbers, colour, combination or Trade Marks as appearing in the representation.

353760 -001

26 NOV 2021



Ms. DHARTI SHAH
(Authorized Agent of the Applicant)
(IN/PA- 2590)

(REPRESENTATION SHEETS)

NAME OF THE APPLICANT
YOGIRAJ BRAHMBHATT
SHACHI JOSHI
HARDIKA MENGHANI

NO. OF SHEETS - 3
SHEET NO. - 3



RIGHT SIDE VIEW



LEFT SIDE VIEW

The novelty resides in the shape and configuration of the 'MOBILE KICKSTAND COVER WITH ATTACHED EJECTOR PIN' as illustrated.



No claim is made by virtue of this registration in respect of any mechanical or other action of the mechanism whatever or in respect of any mode or principle of construction of the article.

No claim is made by virtue of the registration to any right to the exclusive use of the words, letters, numbers, colour, combination or Trade Marks as appearing in the representation.

353760 -001

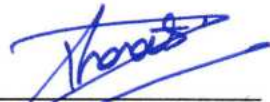
26 NOV 2021

Ms. DHARTI SHAH
(Authorized Agent of the Applicant)
(IN/PA- 2590)

DESIGN NUMBER	353733-001		
CLASS	12-16		
HONDA ACCESS CORP., 18-4, NOBIDOME 8-CHOME, NIIZA-SHI, SAITAMA, 352-8589 JAPAN.			
DATE OF REGISTRATION	26/11/2021		
TITLE	TRUNK SPOILER FOR AN AUTOMOBILE		
PRIORITY			
PRIORITY NUMBER	DATE	COUNTRY	
2021-011732	01/06/2021	JAPAN	
DESIGN NUMBER	353744-001		
CLASS	13-04		
1.NIHAR V. RAVAL, SILVER OAK UNIVERSITY CAMPUS, OPP. BHAGWAT VIDYAPITH, S.G ROAD, GOTA, AHMEDABAD – 382481, INDIA 2. VEDKUMAR NARESHBHAI PATEL, SILVER OAK UNIVERSITY CAMPUS, OPP. BHAGWAT VIDYAPITH, S.G ROAD, GOTA, AHMEDABAD – 382481, INDIA			
DATE OF REGISTRATION	26/11/2021		
TITLE	WALL MOUNTED ACTIVE SOLAR TRACKER		
PRIORITY NA			
DESIGN NUMBER	353760-001		
CLASS	03-01		
1.YOGIRAJ BRAHMBHATT, SILVER OAK UNIVERSITY CAMPUS, OPP. BHAGWAT VIDYAPITH, S.G ROAD, GOTA, AHMEDABAD – 382481, INDIA 2. SHACHI JOSHI, SILVER OAK UNIVERSITY CAMPUS, OPP. BHAGWAT VIDYAPITH, S.G ROAD, GOTA, AHMEDABAD – 382481, INDIA 3. HARDIKA MENGHANI, SILVER OAK UNIVERSITY CAMPUS, OPP. BHAGWAT VIDYAPITH, S.G ROAD, GOTA, AHMEDABAD – 382481, INDIA			
DATE OF REGISTRATION	26/11/2021		
TITLE	MOBILE KICKSTAND COVER WITH ATTACHED EJECTOR PIN		
PRIORITY NA			



ORIGINAL

No. 108065

भारत सरकार
GOVERNMENT OF INDIA
पेटेंट कार्यालय
THE PATENT OFFICE

CERTIFICATE OF REGISTRATION OF DESIGN

Design No. 353741-001
Date 26/11/2021
Reciprocity Date*
Country

Certified that the design of which a copy is annexed hereto has been registered as of the number and date given above in class 15-99 in respect of the application of such design to INDUSTRIAL ROBOT in the name of 1.JENISH PATEL, SILVER OAK UNIVERSITY CAMPUS, OPP. BHAGWAT VIDYAPITH, S.G ROAD, GOTA, AHMEDABAD – 382421, INDIA 2. AMIT SHAH, SILVER OAK UNIVERSITY CAMPUS, OPP. BHAGWAT VIDYAPITH, S.G ROAD, GOTA, AHMEDABAD – 382421, INDIA

in pursuance of and subject to the provisions of the Designs Act, 2000 and the Designs Rules, 2001.

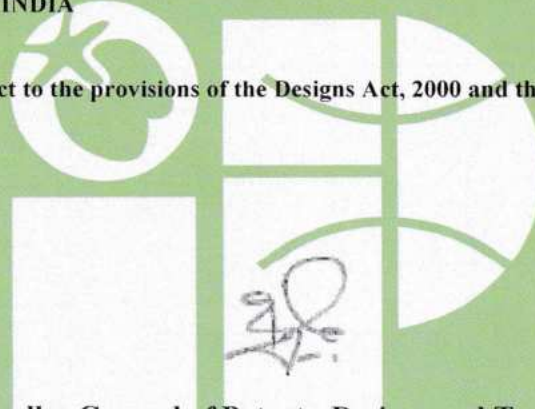

Controller General of Patents, Designs and Trade Marks

*The reciprocity date (if any) which has been allowed and the name of the country.

Copyright in the design will subsist for ten years from the date of Registration, and may under the terms of the Act and Rules, be extended for a further period of five years.

This Certificate is not for use in legal proceedings or for obtaining registration abroad

INTELLECTUAL
PROPERTY INDIA
PATENTS | DESIGNS | TRADE MARKS
GEOGRAPHICAL INDICATIONS

MS. DHARTI SHAH,
VERITE ASSOCIATES, 105, SCARLET GATEWAY, NR.
SPIPA ACADEMY, CORPORATE ROAD,
PRAHALADNAGR, AHMEDABAD-380015, GUJARAT,
INDIA

Date of Issue 28/01/2022 16:52:38

(REPRESENTATION SHEETS)

NAME OF THE APPLICANT
JENISH PATEL
AMIT SHAH

NO. OF SHEETS - 3
SHEET NO. - 1



PERSPECTIVE VIEW

INDUSTRIAL

The novelty resides in the shape and configuration of the '~~ANIMAL LIMB~~ ROBOT' as illustrated.

No claim is made by virtue of this registration in respect of any mechanical or other action of the mechanism whatever or in respect of any mode or principle of construction of the article.

No claim is made by virtue of the registration to any right to the exclusive use of the words, letters, numbers, colour, combination or Trade Marks as appearing in the representation.

Date: 26/11/2021

353741-601

26 NOV 2021

Ms. DHARTI SHAH
(Authorized Agent of the Applicant)
(IN/PA- 2590)

(REPRESENTATION SHEETS)

NAME OF THE APPLICANT
JENISH PATEL
AMIT SHAH

NO. OF SHEETS - 3
SHEET NO. - 2

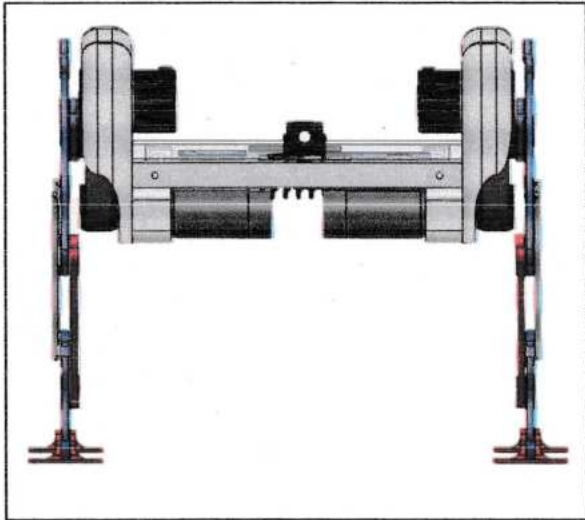

FRONT VIEW

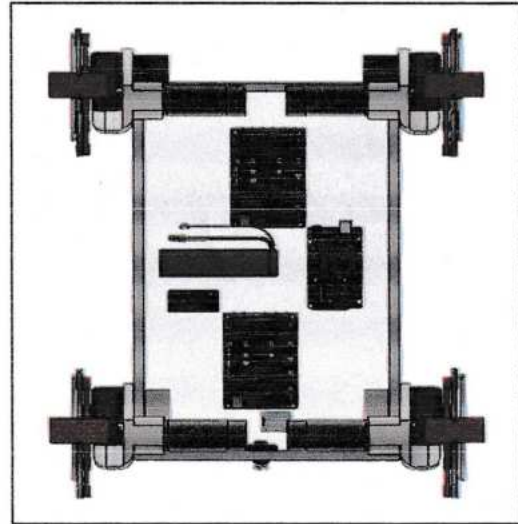

TOP VIEW

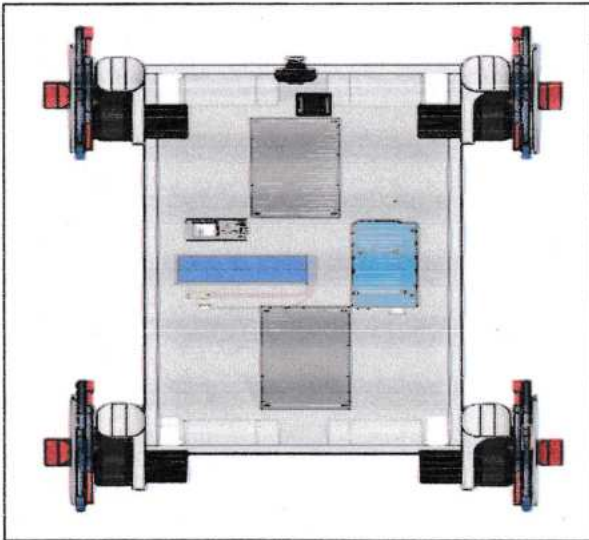

BOTTOM VIEW

INDUSTRIAL

The novelty resides in the shape and configuration of the '**ANIMAL LIMB ROBOT**' as illustrated.

No claim is made by virtue of this registration in respect of any mechanical or other action of the mechanism whatever or in respect of any mode or principle of construction of the article.

No claim is made by virtue of the registration to any right to the exclusive use of the words, letters, numbers, colour, combination or Trade Marks as appearing in the representation.

Date: 26/11/2021

353741-001

26 NOV 2021

Ms. DHARTI SHAH
(Authorized Agent of the Applicant)
(IN/PA- 2590)

(REPRESENTATION SHEETS)

NAME OF THE APPLICANT
JENISH PATEL
AMIT SHAH

NO. OF SHEETS - 3
SHEET NO. - 3

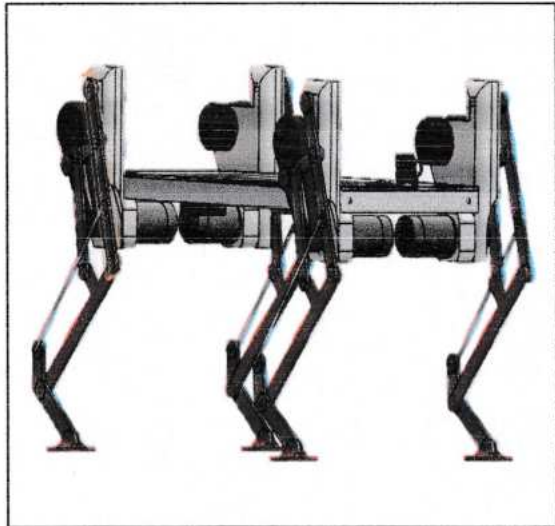

LEFT SIDE VIEW

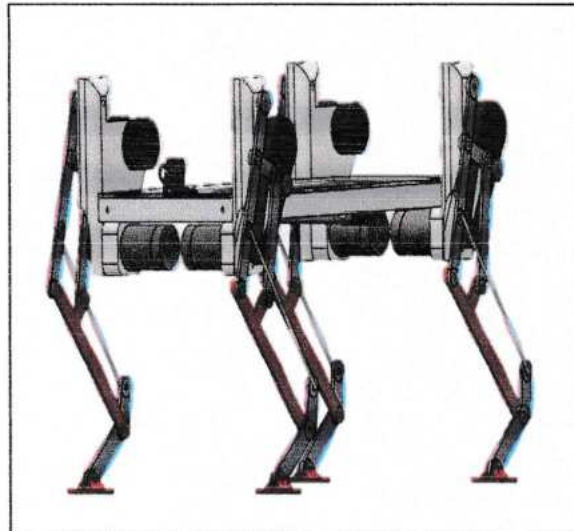

RIGHT SIDE VIEW

INDUSTRIAL
~~ANIMAL LIMB~~ ROBOT
^

The novelty resides in the shape and configuration of the 'ANIMAL LIMB ROBOT' as illustrated.

No claim is made by virtue of this registration in respect of any mechanical or other action of the mechanism whatever or in respect of any mode or principle of construction of the article.

No claim is made by virtue of the registration to any right to the exclusive use of the words, letters, numbers, colour, combination or Trade Marks as appearing in the representation.

Date: 26/11/2021

353741-001

26 NOV 2021

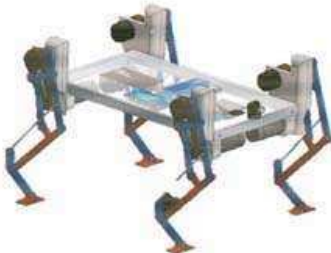
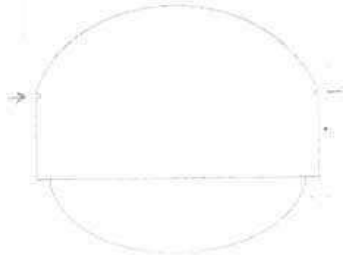

Ms. DHARTI SHAH
(Authorized Agent of the Applicant)
(IN/PA- 2590)

DESIGN NUMBER	353739-001	
CLASS	12-05	
1.KEVAL BHAVSAR, SILVER OAK UNIVERSITY CAMPUS, OPP. BHAGWAT VIDYAPITH, S.G ROAD, GOTA, AHMEDABAD – 382481, INDIA 2. JAIMIN PANCHAL, SILVER OAK UNIVERSITY CAMPUS, OPP. BHAGWAT VIDYAPITH, S.G ROAD, GOTA, AHMEDABAD – 382481, INDIA 3. DHARMIK GOHEL, SILVER OAK UNIVERSITY CAMPUS, OPP. BHAGWAT VIDYAPITH, S.G ROAD, GOTA, AHMEDABAD – 382481, INDIA 4. HITESH PRAJAPATI, SILVER OAK UNIVERSITY CAMPUS, OPP. BHAGWAT VIDYAPITH, S.G ROAD, GOTA, AHMEDABAD – 382481, INDIA , ET AL.		
DATE OF REGISTRATION	26/11/2021	
TITLE	CONVEYOR MACHINE	
PRIORITY NA		
DESIGN NUMBER	353741-001	
CLASS	15-99	
1.JENISH PATEL, SILVER OAK UNIVERSITY CAMPUS, OPP. BHAGWAT VIDYAPITH, S.G ROAD, GOTA, AHMEDABAD – 382421, INDIA 2. AMIT SHAH, SILVER OAK UNIVERSITY CAMPUS, OPP. BHAGWAT VIDYAPITH, S.G ROAD, GOTA, AHMEDABAD – 382421, INDIA		
DATE OF REGISTRATION	26/11/2021	
TITLE	INDUSTRIAL ROBOT	
PRIORITY NA		
DESIGN NUMBER	307405	
CLASS	28-01	
NON DESTRUCTIVE ENGINEERING COMPANY LTD., 15-C, LAXMI INDUSTRIAL ESTATE, NEW LINK ROAD, ANDHERI WEST, MUMBAI 400053, STATE OF MAHARASHTRA, INDIA		
DATE OF REGISTRATION	05/07/2018	
TITLE	CAPSULE	
PRIORITY NA		



ORIGINAL

No. 112302

भारत सरकार
GOVERNMENT OF INDIA
पेटेंट कार्यालय
THE PATENT OFFICE

CERTIFICATE OF REGISTRATION OF DESIGN

Design No. 357856-001
Date 03/02/2022 19:29:25
Reciprocity Date*
Country

Certified that the design of which a copy is annexed hereto has been registered as of the number and date given above in class 07-04 in respect of the application of such design to VEGETABLE PEELER in the name of 1.PROF. HIMANI MITTAL, SILVER OAK UNIVERSITY CAMPUS, OPP. BHAGWAT VIDYAPITH, S.G ROAD, GOTA, AHMEDABAD – 382421, INDIA 2. HARSH AGRAWAL, SILVER OAK UNIVERSITY CAMPUS, OPP. BHAGWAT VIDYAPITH, S.G ROAD, GOTA, AHMEDABAD – 382421, INDIA 3. SWETA MITTAL, SILVER OAK UNIVERSITY CAMPUS, OPP. BHAGWAT VIDYAPITH, S.G ROAD, GOTA, AHMEDABAD – 382421, INDIA.

in pursuance of and subject to the provisions of the Designs Act, 2000 and the Designs Rules, 2001.

Controller General of Patents, Designs and Trade Marks

*The reciprocity date (if any) which has been allowed and the name of the country.

Copyright in the design will subsist for ten years from the date of Registration, and may under the terms of the Act and Rules, be extended for a further period of five years.

This Certificate is not for use in legal proceedings or for obtaining registration abroad

MS.DHARTI SHAH,
VERITE ASSOCIATES, 105, SCARLET GATEWAY,
NR. SPIPA ACADEMY, CORPORATE ROAD,
PRAHALADNAGR, AHMEDABAD-380015, GUJARAT,
INDIA

Date of Issue 26/04/2022 12:10:47

(REPRESENTATION SHEETS)

NAME OF THE APPLICANT
PROF. HIMANI MITTAL
HARSH AGRAWAL
SWETA MITTAL

NO. OF SHEETS - 3
SHEET NO. - 1



PERSPECTIVE VIEW

The novelty resides in the shape and configuration of the 'VEGETABLE PEELER' as illustrated.

No claim is made by virtue of this registration in respect of any mechanical or other action of the mechanism whatever or in respect of any mode or principle of construction of the article.

No claim is made by virtue of the registration to any right to the exclusive use of the words, letters, numbers, colour, combination or Trade Marks as appearing in the representation.

357856 -001

03 FEB 2022

Dated this 2nd Day of February 2022.

Ms. DHARTI SHAH
(Authorized Agent of the Applicant)
(IN/PA- 2590)

(REPRESENTATION SHEETS)

NAME OF THE APPLICANT
PROF. HIMANI MITTAL
HARSH AGRAWAL
SWETA MITTAL

NO. OF SHEETS - 3
SHEET NO. - 2



FRONT VIEW



BACK VIEW



BOTTOM VIEW

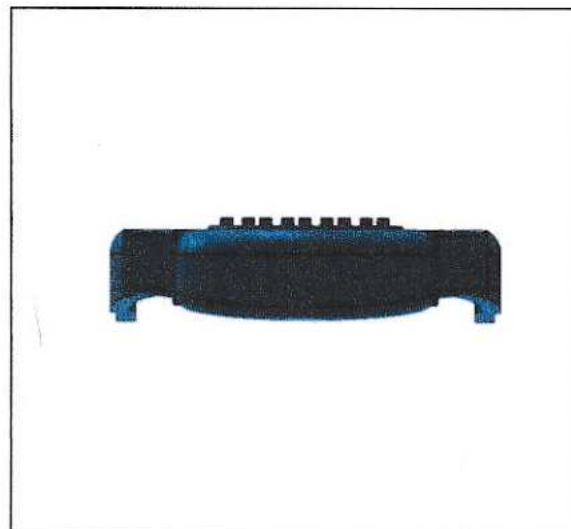

TOP VIEW

The novelty resides in the shape and configuration of the 'VEGETABLE PEELER' as illustrated.

No claim is made by virtue of this registration in respect of any mechanical or other action of the mechanism whatever or in respect of any mode or principle of construction of the article.

No claim is made by virtue of the registration to any right to the exclusive use of the words, letters, numbers, colour, combination or Trade Marks as appearing in the representation.

357856-001

03 FEB 2022

Dated this 2nd Day of February 2022.

Ms. DHARTI SHAH
(Authorized Agent of the Applicant)
(IN/PA- 2590)

(REPRESENTATION SHEETS)

NAME OF THE APPLICANT
PROF. HIMANI MITTAL
HARSH AGRAWAL
SWETA MITTAL

NO. OF SHEETS - 3
SHEET NO. - 3

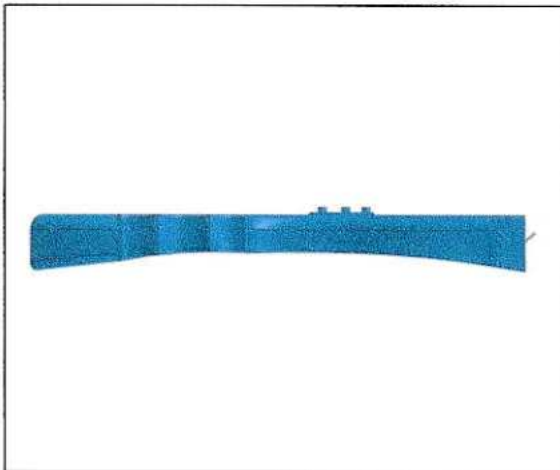

RIGHT SIDE VIEW

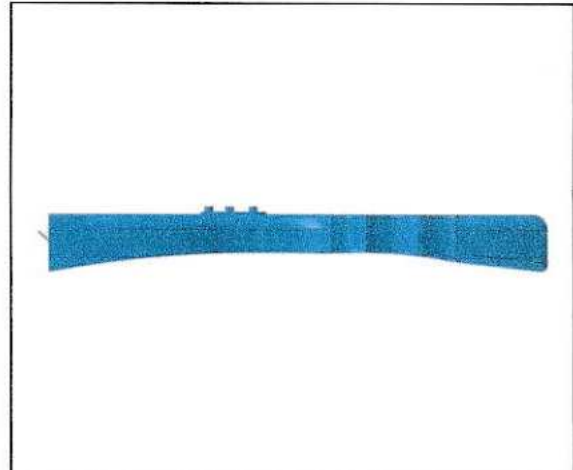

LEFT SIDE VIEW

The novelty resides in the shape and configuration of the 'VEGETABLE PEELER' as illustrated.

No claim is made by virtue of this registration in respect of any mechanical or other action of the mechanism whatever or in respect of any mode or principle of construction of the article.



No claim is made by virtue of the registration to any right to the exclusive use of the words, letters, numbers, colour, combination or Trade Marks as appearing in the representation.

357856-001

03 FEB 2022

Dated this 2nd Day of February 2022.

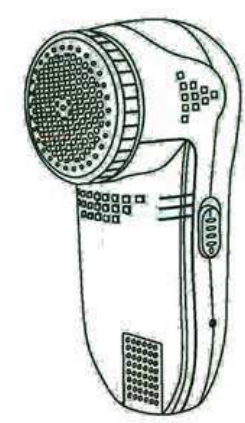
Ms. DHARTI SHAH
(Authorized Agent of the Applicant)
(IN/PA- 2590)

DESIGN NUMBER	357766-001	
CLASS	07-05	
VANDNA 485 FIRST FLOOR NEAR VISHAL MARKET WEST PARMANAND COLONY DR. MUKHERJEE NAGAR DELHI -110009,		
DATE OF REGISTRATION	02/02/2022	
TITLE	FABRIC CLEANER	
PRIORITY NA		
DESIGN NUMBER	357856-001	
CLASS	07-04	
1.PROF. HIMANI MITTAL SILVER OAK UNIVERSITY CAMPUS, OPP. BHAGWAT VIDYAPITH, S.G ROAD, GOTTA, AHMEDABAD – 382421, INDIA 2. HARSH AGRAWAL SILVER OAK UNIVERSITY CAMPUS, OPP. BHAGWAT VIDYAPITH, S.G ROAD, GOTTA, AHMEDABAD – 382421, INDIA 3. SWETA MITTAL SILVER OAK UNIVERSITY CAMPUS, OPP. BHAGWAT VIDYAPITH, S.G ROAD, GOTTA, AHMEDABAD – 382421, INDIA.		
DATE OF REGISTRATION	03/02/2022	
TITLE	VEGETABLE PEELER	
PRIORITY NA		
DESIGN NUMBER	357884-001	
CLASS	15-03	
1.R. DEEPAK SURESH KUMAR ASSISTANT PROFESSOR, DEPARTMENT OF MECHANICAL ENGINEERING, RAJALAKSHMI INSTITUTE OF TECHNOLOGY, INDIA 2. NISHANTH S.M. 5B, SRI MARUTHI NAGAR, KOZHUMANIVAKKAM, NELLIMANAGAR, MANGADU, CHENNAI-600122, INDIA 3. SRIVARDHAN R. FLAT NO. 7, S1, GOKULAM KANNAN APARTMENT, SUNDAR NAGAR, POONAMALLEE, CHENNAI-600056, INDIA		
DATE OF REGISTRATION	04/02/2022	
TITLE	A VERSATILE STREW CONTRIVANCE INTEGRATED WITH FERTILISER	
PRIORITY NA		



ORIGINAL

No. 111728

भारत सरकार
GOVERNMENT OF INDIA
पेटेंट कार्यालय
THE PATENT OFFICE

CERTIFICATE OF REGISTRATION OF DESIGN

Design No. 357857-001
Date 03/02/2022 19:29:25
Reciprocity Date*
Country

Certified that the design of which a copy is annexed hereto has been registered as of the number and date given above in class 12-11 in respect of the application of such design to TWO WHEELER'S DOUBLE STAND in the name of PROF. HARESH RAMANALAL PARMAR, SILVER OAK UNIVERSITY CAMPUS, OPP. BHAGWAT VIDYAPITH, S.G ROAD, GOTA, AHMEDABAD - 382481, INDIA

in pursuance of and subject to the provisions of the Designs Act, 2000 and the Designs Rules, 2001.

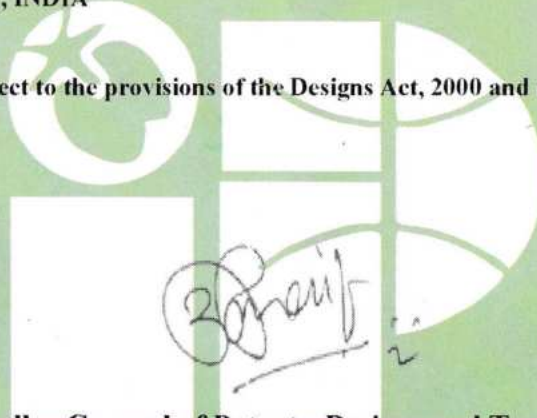

Controller General of Patents, Designs and Trade Marks

*The reciprocity date (if any) which has been allowed and the name of the country.

Copyright in the design will subsist for ten years from the date of Registration, and may under the terms of the Act and Rules, be extended for a further period of five years.

This Certificate is not for use in legal proceedings or for obtaining registration abroad

MS. DHARTI SHAH,
VERITE ASSOCIATES, 105, SCARLET GATEWAY,
NR. SPIPA ACADEMY, CORPORATE ROAD,
PRAHALADNAGR, AHMEDABAD-380015, GUJARAT,
INDIA

Date of Issue 18/04/2022 16:39:23

INTELLECTUAL
PROPERTY INDIA
PATENTS | DESIGNS | TRADE MARKS
GEOGRAPHICAL INDICATIONS

(REPRESENTATION SHEETS)

NAME OF THE APPLICANT
PROF. HARESH RAMANLAL PARMAR

NO. OF SHEETS - 3
SHEET NO. - 1

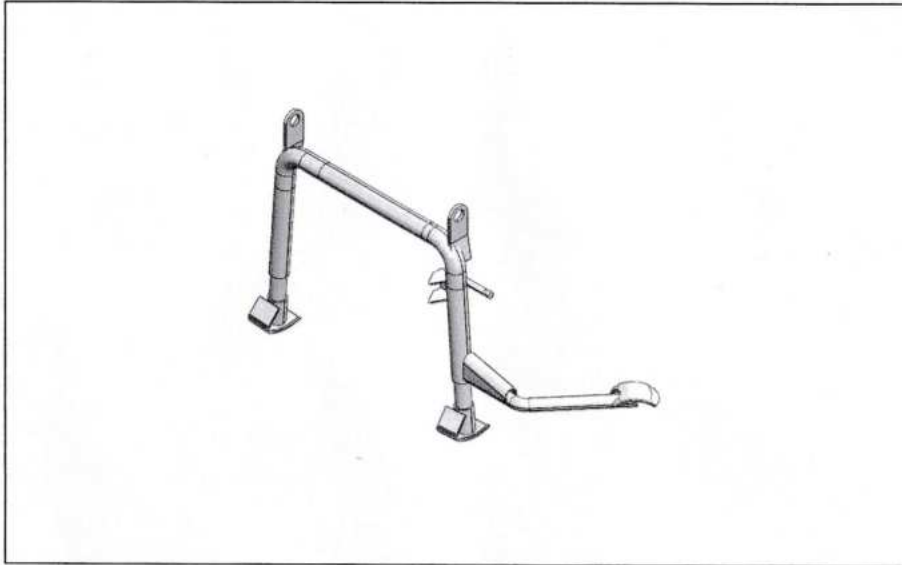

PERSPECTIVE VIEW

The novelty resides in the shape and configuration of the 'TWO WHEELER'S DOUBLE STAND.' as illustrated.

No claim is made by virtue of this registration in respect of any mechanical or other action of the mechanism whatever or in respect of any mode or principle of construction of the article.

No claim is made by virtue of the registration to any right to the exclusive use of the words, letters, numbers, colour, combination or Trade Marks as appearing in the representation.

357857-001

03 FEB 2022

Dated this 2nd Day of February 2022.

Ms. DHARTI SHAH
(Authorized Agent of the Applicant)
(IN/PA- 2590)

(REPRESENTATION SHEETS)

NAME OF THE APPLICANT
PROF. HARESH RAMANLAL PARMAR

NO. OF SHEETS - 3
SHEET NO. - 2



FRONT VIEW



BACK VIEW

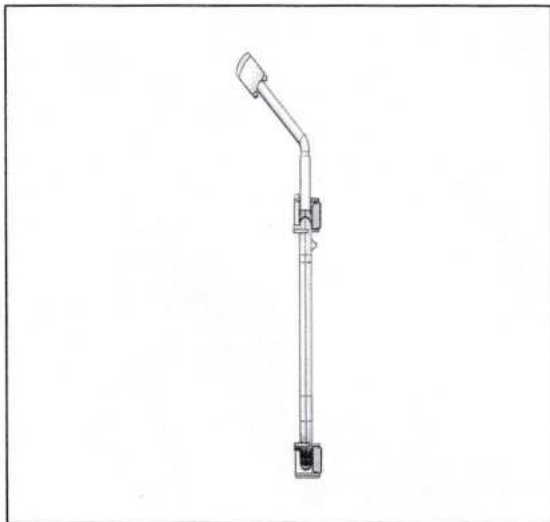

TOP VIEW

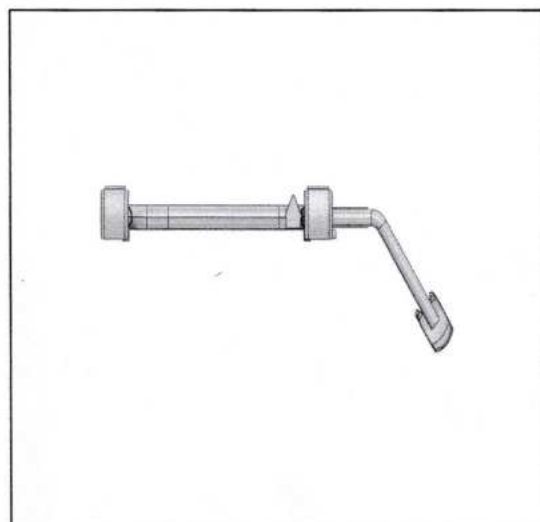

BOTTOM VIEW

The novelty resides in the shape and configuration of the 'TWO WHEELER'S DOUBLE STAND.' as illustrated.

No claim is made by virtue of this registration in respect of any mechanical or other action of the mechanism whatever or in respect of any mode or principle of construction of the article.

No claim is made by virtue of the registration to any right to the exclusive use of the words, letters, numbers, colour, combination or Trade Marks as appearing in the representation.

357857-001

03 FEB 2022

Dated this 2nd Day of February 2022.

Ms. DHARTI SHAH
(Authorized Agent of the Applicant)
(IN/PA- 2590)

(REPRESENTATION SHEETS)

NAME OF THE APPLICANT
PROF. HARESH RAMANLAL PARMAR

NO. OF SHEETS - 3
SHEET NO. - 3

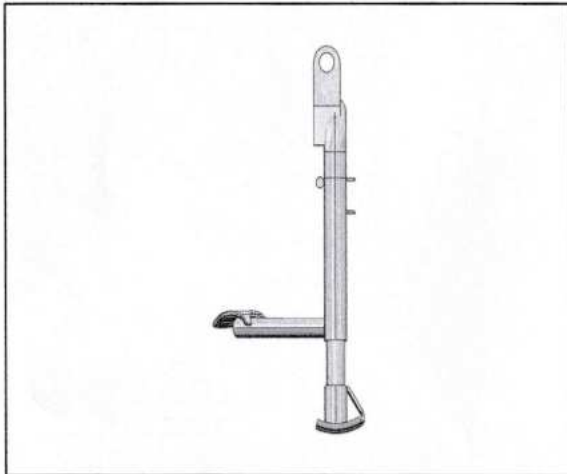

RIGHT SIDE VIEW



LEFT SIDE VIEW

The novelty resides in the shape and configuration of the 'TWO WHEELER'S DOUBLE STAND.' as illustrated.

No claim is made by virtue of this registration in respect of any mechanical or other action of the mechanism whatever or in respect of any mode or principle of construction of the article.

No claim is made by virtue of the registration to any right to the exclusive use of the words, letters, numbers, colour, combination or Trade Marks as appearing in the representation.

357857-001

03 FEB 2022

Dated this 2nd Day of February 2022.

Ms. DHARTI SHAH
(Authorized Agent of the Applicant)
(IN/PA- 2590)

DESIGN NUMBER	357857-001	
CLASS	12-11	
PROF. HARESH RAMANALAL PARMAR SILVER OAK UNIVERSITY CAMPUS, OPP. BHAGWAT VIDYAPITH, S.G ROAD, GOTTA, AHMEDABAD – 382481, INDIA		
DATE OF REGISTRATION	03/02/2022	
TITLE	TWO WHEELER'S DOUBLE STAND	
PRIORITY NA		
DESIGN NUMBER	357859-001	
CLASS	03-03	
1.DR. SATVIK KHARA SILVER OAK UNIVERSITY CAMPUS, OPP. BHAGWAT VIDYAPITH, S.G ROAD, GOTTA, AHMEDABAD – 382481, INDIA 2. PROF. BHARGAV MODI SILVER OAK UNIVERSITY CAMPUS, OPP. BHAGWAT VIDYAPITH, S.G ROAD, GOTTA, AHMEDABAD – 382481, INDIA 3. PROF. HEMAL PATEL SILVER OAK UNIVERSITY CAMPUS, OPP. BHAGWAT VIDYAPITH, S.G ROAD, GOTTA, AHMEDABAD – 382481, INDIA 4. PROF. HIMANSHU PRAJAPATI SILVER OAK UNIVERSITY CAMPUS, OPP. BHAGWAT VIDYAPITH, S.G ROAD, GOTTA, AHMEDABAD – 382481, INDIA		
DATE OF REGISTRATION	03/02/2022	
TITLE	BMM WALKING STICK WITH UMBRELLA	
PRIORITY NA		
DESIGN NUMBER	357871-001	
CLASS	12-05	
1.CT INSTITUTE OF ENGINEERING, MANAGEMENT & TECHNOLOGY PRATHAPURA ROAD, URBAN ESTATE PHASE II, SHAHPUR, PUNJAB-144020, INDIA. 2. AMIT KUMAR CT INSTITUTE OF ENGINEERING, MANAGEMENT & TECHNOLOGY, PRATHAPURA ROAD, URBAN ESTATE PHASE II, SHAHPUR, PUNJAB-144020, INDIA. 3. DR. GUNJAN BHALLA CT INSTITUTE OF ENGINEERING, MANAGEMENT & TECHNOLOGY, PRATHAPURA ROAD, URBAN ESTATE PHASE II, SHAHPUR, PUNJAB-144020, INDIA. 4. IPANDEEP SINGH CT INSTITUTE OF ENGINEERING, MANAGEMENT & TECHNOLOGY, PRATHAPURA ROAD, URBAN ESTATE PHASE II, SHAHPUR, PUNJAB-144020, INDIA. , ET AL.		
DATE OF REGISTRATION	03/02/2022	
TITLE	MOVABLE CARGO LIFTER	
PRIORITY NA		



सब्यमेव जयते

ORIGINAL

No. 113633

भारत सरकार
GOVERNMENT OF INDIA
पेटेंट कार्यालय
THE PATENT OFFICE

CERTIFICATE OF REGISTRATION OF DESIGN

Design No. 360075-001
Date 07/03/2022 20:38:47
Reciprocity Date*
Country

Certified that the design of which a copy is annexed hereto has been registered as of the number and date given above in class 09-09 in respect of the application of such design to SMART PLASTIC WASTE MANAGEMENT SYSTEM in the name of 1.PROF. MANAN PATHAK, SILVER OAK UNIVERSITY CAMPUS, OPP. BHAGWAT VIDYAPITH, S.G ROAD, GOTA, AHMEDABAD – 382481, INDIA 2. MR. JAY PATEL, SILVER OAK UNIVERSITY CAMPUS, OPP. BHAGWAT VIDYAPITH, S.G ROAD, GOTA, AHMEDABAD – 382481, INDIA 3. MR. SAGAR SONI, SILVER OAK UNIVERSITY CAMPUS, OPP. BHAGWAT VIDYAPITH, S.G ROAD, GOTA, AHMEDABAD – 382481, INDIA

in pursuance of and subject to the provisions of the Designs Act, 2000 and the Designs Rules, 2001.

Controller General of Patents, Designs and Trade Marks

*The reciprocity date (if any) which has been allowed and the name of the country.

Copyright in the design will subsist for ten years from the date of Registration, and may under the terms of the Act and Rules, be extended for a further period of five years.

This Certificate is not for use in legal proceedings or for obtaining registration abroad

MS. DHARTI SHAH,
VERITE ASSOCIATES, 105 SCARLET GATEWAY, NR.
SPIPA ACADEMY, CORPORATE ROAD,
PRAHLADNAGAR, AHMEDABAD-380015, GUJARAT,
INDIA

PROPERTY INDIA
PATENTS | DESIGNS | TRADE MARKS
APPROVAL INDICATIONS

Date of Issue 13/05/2022 12:59:26

(REPRESENTATION SHEETS)

NAME OF THE APPLICANT
PROF. MANAN PATHAK
MR. JAY PATEL
MR. SAGAR SONI

NO. OF SHEETS - 3
SHEET NO. - 1

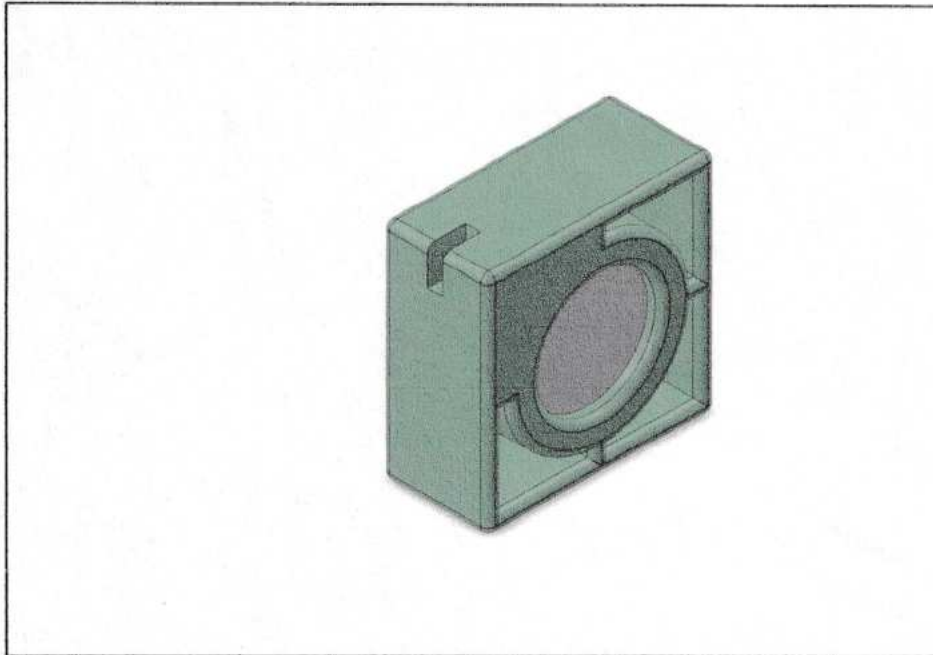

PERSPECTIVE VIEW

The novelty resides in the shape and configuration of the '**SMART PLASTIC WASTE MANAGEMENT SYSTEM**' as illustrated.

No claim is made by virtue of this registration in respect of any mechanical or other action of the mechanism whatever or in respect of any mode or principle of construction of the article.

No claim is made by virtue of the registration to any right to the exclusive use of the words, letters, numbers, colour, combination or Trade Marks as appearing in the representation.

360075-001

07 MAR 2022

Dated this 5th Day of March 2022.

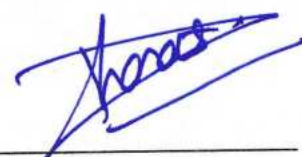
Ms. DHARTI SHAH
(Authorized Agent of the Applicant)
(IN/PA- 2590)

(REPRESENTATION SHEETS)

NAME OF THE APPLICANT
PROF. MANAN PATHAK
MR. JAY PATEL
MR. SAGAR SONI

NO. OF SHEETS - 3
SHEET NO. - 2

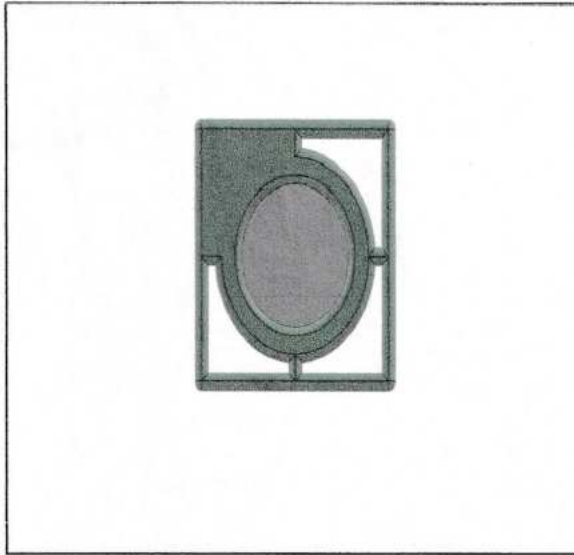

FRONT VIEW

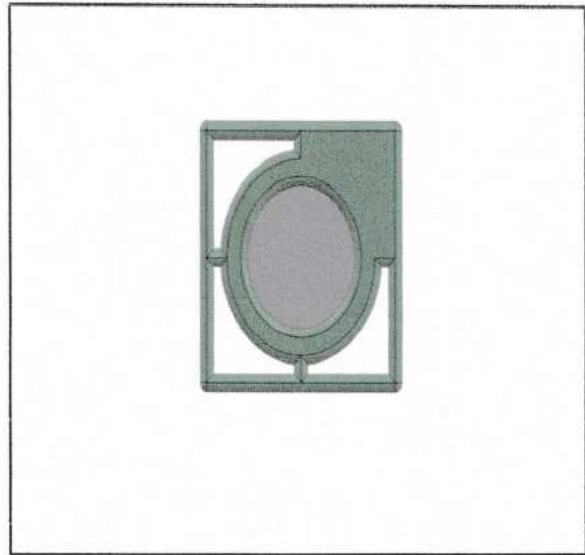

BACK VIEW



TOP VIEW

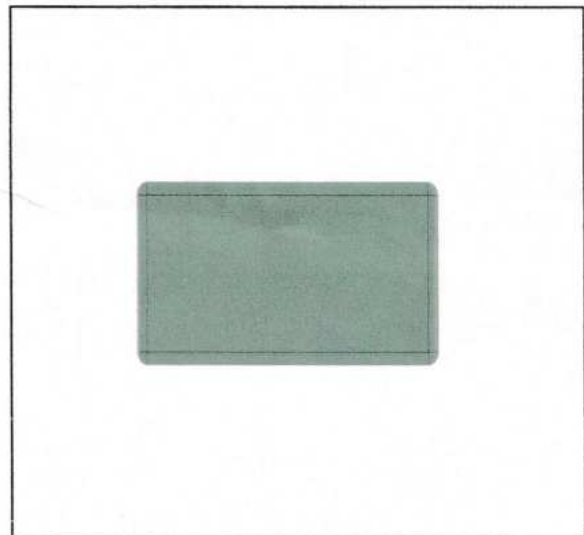

BOTTOM VIEW

The novelty resides in the shape and configuration of the 'SMART PLASTIC WASTE MANAGEMENT SYSTEM' as illustrated.

No claim is made by virtue of this registration in respect of any mechanical or other action of the mechanism whatever or in respect of any mode or principle of construction of the article.

No claim is made by virtue of the registration to any right to the exclusive use of the words, letters, numbers, colour, combination or Trade Marks as appearing in the representation.

360075-001

07 MAR 2022

Dated this 5th Day of March 2022.

Ms. DHARTI SHAH
(Authorized Agent of the Applicant)
(IN/PA- 2590)

(REPRESENTATION SHEETS)

NAME OF THE APPLICANT
PROF. MANAN PATHAK
MR. JAY PATEL
MR. SAGAR SONI

NO. OF SHEETS - 3
SHEET NO. - 3

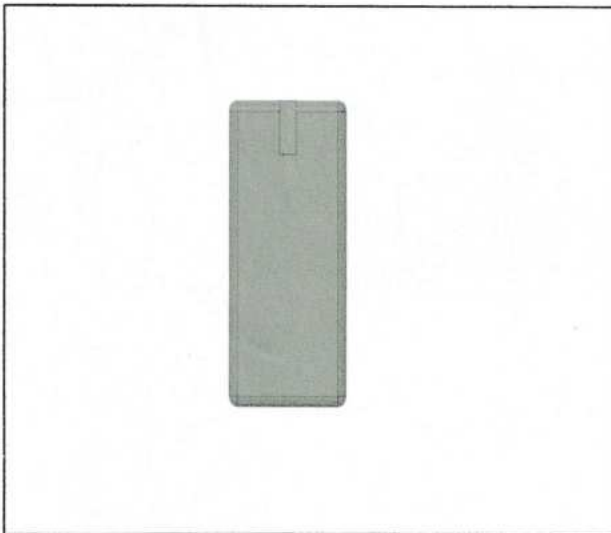

LEFT SIDE VIEW

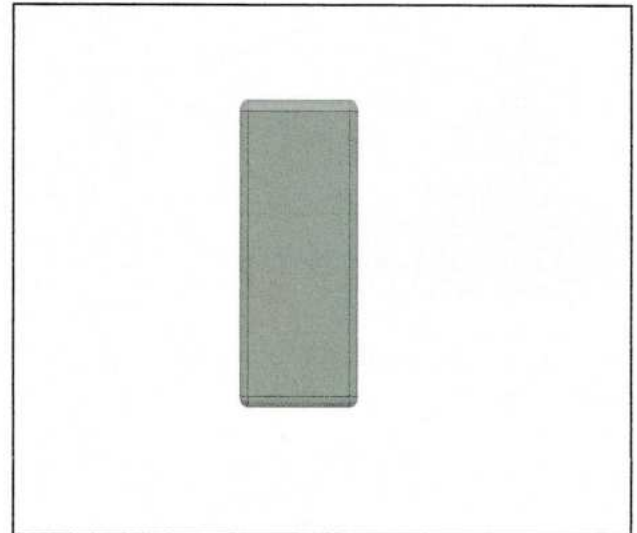

RIGHT SIDE VIEW

The novelty resides in the shape and configuration of the 'SMART PLASTIC WASTE MANAGEMENT SYSTEM' as illustrated.

No claim is made by virtue of this registration in respect of any mechanical or other action of the mechanism whatever or in respect of any mode or principle of construction of the article.



No claim is made by virtue of the registration to any right to the exclusive use of the words, letters, numbers, colour, combination or Trade Marks as appearing in the representation.

360075-001

07 MAR 2022

Dated this 5th Day of March 2022.

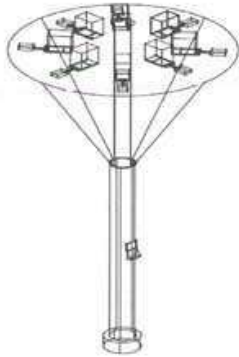
Ms. DHARTI SHAH
(Authorized Agent of the Applicant)
(IN/PA- 2590)

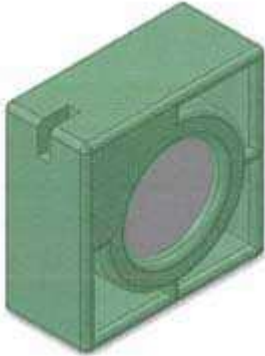
DESIGN NUMBER	360066-001	
CLASS	24-02	
1.MR. SIDDHARTH KURMI SILVER OAK UNIVERSITY CAMPUS, OPP. BHAGWAT VIDYAPITH, S.G ROAD, GOTA, AHMEDABAD – 382481 2. MR. NOEL GEO MATHEWS SILVER OAK UNIVERSITY CAMPUS, OPP. BHAGWAT VIDYAPITH, S.G ROAD, GOTA, AHMEDABAD – 382481 3. MR. ANIKET GUPTA SILVER OAK UNIVERSITY CAMPUS, OPP. BHAGWAT VIDYAPITH, S.G ROAD, GOTA, AHMEDABAD – 382481 4. MR. DEVANSHU JADOUN SILVER OAK UNIVERSITY CAMPUS, OPP. BHAGWAT VIDYAPITH, S.G ROAD, GOTA, AHMEDABAD – 382481 , ET AL.		
DATE OF REGISTRATION	07/03/2022	
TITLE	MEDBAY	
PRIORITY NA		
DESIGN NUMBER	360068-001	
CLASS	06-03	
1.MR. DEVANSH SHAILESHBHAI SHAH SILVER OAK UNIVERSITY CAMPUS, OPP. BHAGWAT VIDYAPITH, S.G ROAD, GOTA, AHMEDABAD – 382481 2. MR. KEVAL VIPULKUMAR BHAVSAR SILVER OAK UNIVERSITY CAMPUS, OPP. BHAGWAT VIDYAPITH, S.G ROAD, GOTA, AHMEDABAD – 382481 3. MR.UMANG VIJAYKUMAR PARMAR SILVER OAK UNIVERSITY CAMPUS, OPP. BHAGWAT VIDYAPITH, S.G ROAD, GOTA, AHMEDABAD – 382481		
DATE OF REGISTRATION	07/03/2022	
TITLE	PORTABLE MOBILE PHONE HOLDER WITH WRITING DESK	
PRIORITY NA		
DESIGN NUMBER	360075-001	
CLASS	09-09	
1.PROF. MANAN PATHAK SILVER OAK UNIVERSITY CAMPUS, OPP. BHAGWAT VIDYAPITH, S.G ROAD, GOTA, AHMEDABAD – 382481, INDIA 2. MR. JAY PATEL SILVER OAK UNIVERSITY CAMPUS, OPP. BHAGWAT VIDYAPITH, S.G ROAD, GOTA, AHMEDABAD – 382481, INDIA 3. MR. SAGAR SONI SILVER OAK UNIVERSITY CAMPUS, OPP. BHAGWAT VIDYAPITH, S.G ROAD, GOTA, AHMEDABAD – 382481, INDIA		
DATE OF REGISTRATION	07/03/2022	
TITLE	SMART PLASTIC WASTE MANAGEMENT SYSTEM	
PRIORITY NA		



ORIGINAL

No. 112118

भारत सरकार
GOVERNMENT OF INDIA
पेटेंट कार्यालय
THE PATENT OFFICE

CERTIFICATE OF REGISTRATION OF DESIGN

Design No. 357863-001
Date 03/02/2022 19:29:25
Reciprocity Date*
Country

Certified that the design of which a copy is annexed hereto has been registered as of the number and date given above in class 15-05 in respect of the application of such design to AUTOMATIC SOLAR PANEL DUST CLEANING SYSTEM in the name of 1.PROF. MANAN PATHAK, SILVER OAK UNIVERSITY CAMPUS, OPP. BHAGWAT VIDYAPITH, S.G ROAD, GOTA, AHMEDABAD – 382481, INDIA 2. JAY PATEL, SILVER OAK UNIVERSITY CAMPUS, OPP. BHAGWAT VIDYAPITH, S.G ROAD, GOTA, AHMEDABAD – 382481, INDIA 3. SAGAR SONI, SILVER OAK UNIVERSITY CAMPUS, OPP. BHAGWAT VIDYAPITH, S.G ROAD, GOTA, AHMEDABAD – 382481, INDIA

in pursuance of and subject to the provisions of the Designs Act, 2000 and the Designs Rules, 2001.

Controller General of Patents, Designs and Trade Marks

*The reciprocity date (if any) which has been allowed and the name of the country.

Copyright in the design will subsist for ten years from the date of Registration, and may under the terms of the Act and Rules, be extended for a further period of five years.

This Certificate is not for use in legal proceedings or for obtaining registration abroad

MS. DHARTI SHAH,
VERITE ASSOCIATES, 105, SCARLET GATEWAY,
NR. SPIA ACADEMY, CORPORATE ROAD,
PRAHALADNAGR, AHMEDABAD-380015, GUJARAT,
INDIA

Date of Issue 25/04/2022 15:00:17

(REPRESENTATION SHEETS)

NAME OF THE APPLICANT
PROF. MANAN PATHAK
JAY PATEL
SAGAR SONI

NO. OF SHEETS - 3
SHEET NO. - 1

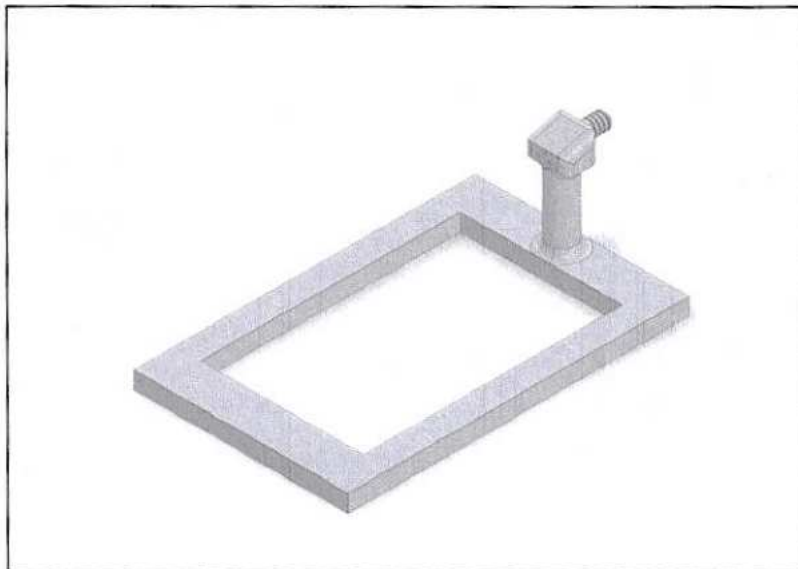

PERSPECTIVE VIEW

The novelty resides in the shape and configuration of the 'AUTOMATIC SOLAR PANEL DUST CLEANING SYSTEM' as illustrated.

No claim is made by virtue of this registration in respect of any mechanical or other action of the mechanism whatever or in respect of any mode or principle of construction of the article.

No claim is made by virtue of the registration to any right to the exclusive use of the words, letters, numbers, colour, combination or Trade Marks as appearing in the representation.

357863-001

03 FEB 2022

Dated this 2nd Day of February 2022.

Ms. DHARTI SHAH
(Authorized Agent of the Applicant)
(IN/PA- 2590)

(REPRESENTATION SHEETS)

NAME OF THE APPLICANT
PROF. MANAN PATHAK
JAY PATEL
SAGAR SONI

NO. OF SHEETS - 3
SHEET NO. - 2

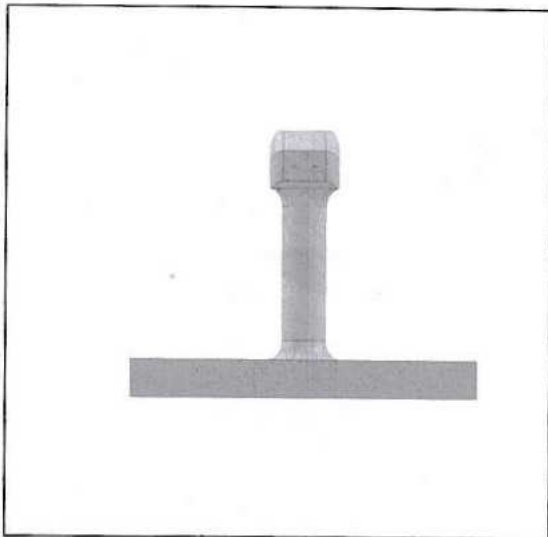

FRONT VIEW

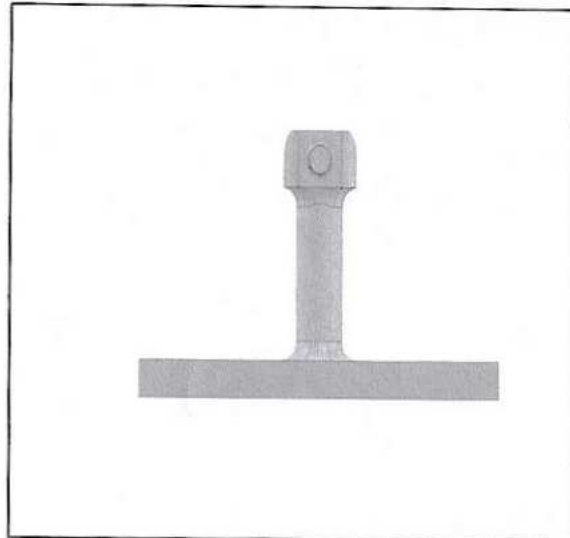

BACK VIEW

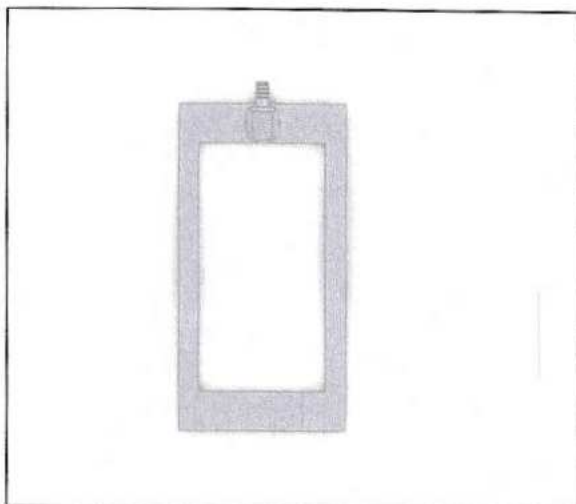

TOP VIEW

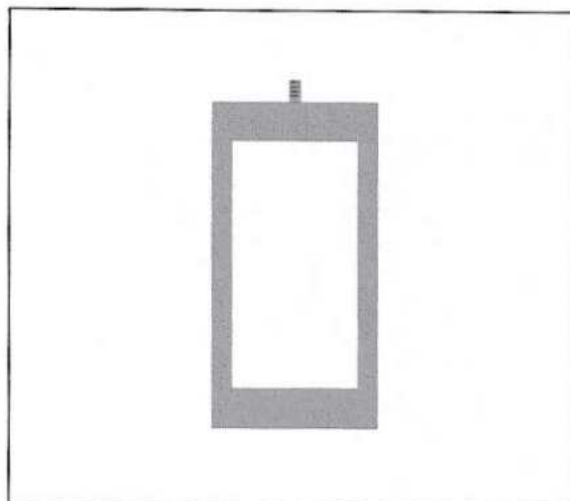

BOTTOM VIEW

The novelty resides in the shape and configuration of the 'AUTOMATIC SOLAR PANEL DUST CLEANING SYSTEM' as illustrated.

No claim is made by virtue of this registration in respect of any mechanical or other action of the mechanism whatever or in respect of any mode or principle of construction of the article.

No claim is made by virtue of the registration to any right to the exclusive use of the words, letters, numbers, colour, combination or Trade Marks as appearing in the representation.

357863-001

n 3 FEB 2022

Dated this 2nd Day of February 2022.



Ms. DHARTI SHAH
(Authorized Agent of the Applicant)
(IN/PA- 2590)

(REPRESENTATION SHEETS)

NAME OF THE APPLICANT
PROF. MANAN PATHAK
JAY PATEL
SAGAR SONI

NO. OF SHEETS - 3
SHEET NO. - 3

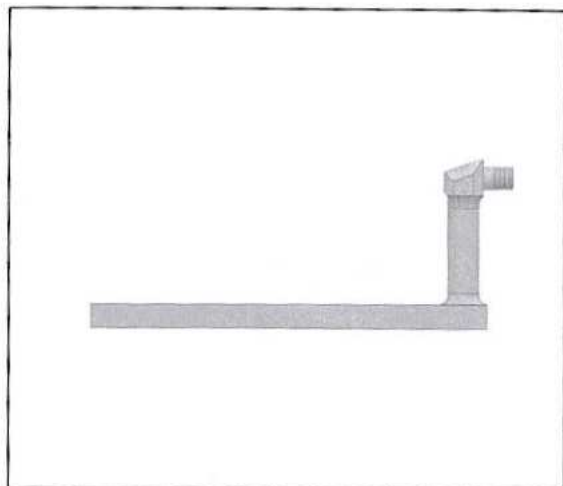

RIGHT SIDE VIEW

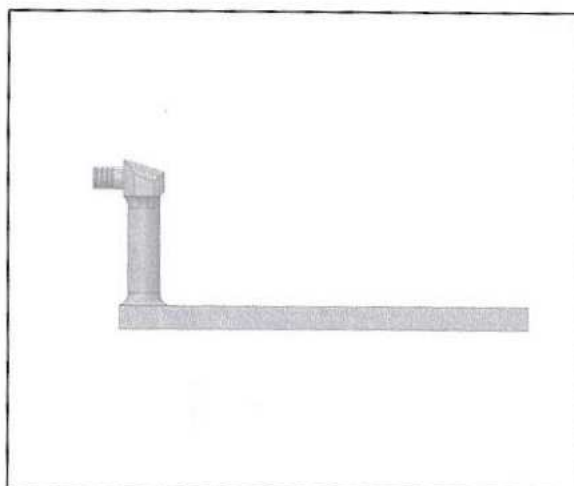

LEFT SIDE VIEW

The novelty resides in the shape and configuration of the 'AUTOMATIC SOLAR PANEL DUST CLEANING SYSTEM' as illustrated.

No claim is made by virtue of this registration in respect of any mechanical or other action of the mechanism whatever or in respect of any mode or principle of construction of the article.



No claim is made by virtue of the registration to any right to the exclusive use of the words, letters, numbers, colour, combination or Trade Marks as appearing in the representation.

357883-001

03 FEB 2022

Dated this 2nd Day of February 2022.

Ms. DHARTI SHAH
(Authorized Agent of the Applicant)
(IN/PA- 2590)

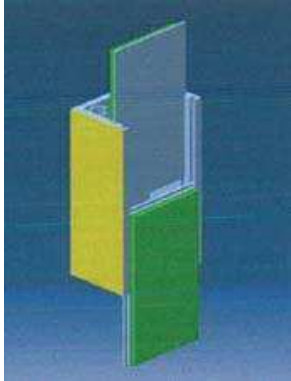
DESIGN NUMBER	357860-001	
CLASS	23-01	
1.PROF. MOHAMMAD IMRAN SILVER OAK UNIVERSITY CAMPUS, OPP. BHAGWAT VIDYAPITH, S.G ROAD, GOTTA, AHMEDABAD – 382421, INDIA. 2. MITESHKUMAR PATEL SILVER OAK UNIVERSITY CAMPUS, OPP. BHAGWAT VIDYAPITH, S.G ROAD, GOTTA, AHMEDABAD – 382421, INDIA.		
DATE OF REGISTRATION	03/02/2022	
TITLE	WASTE WATER DISPOSAL DEVICE	
PRIORITY NA		
DESIGN NUMBER	357863-001	
CLASS	15-05	
1.PROF. MANAN PATHAK SILVER OAK UNIVERSITY CAMPUS, OPP. BHAGWAT VIDYAPITH, S.G ROAD, GOTTA, AHMEDABAD – 382481, INDIA 2. JAY PATEL SILVER OAK UNIVERSITY CAMPUS, OPP. BHAGWAT VIDYAPITH, S.G ROAD, GOTTA, AHMEDABAD – 382481, INDIA 3. SAGAR SONI SILVER OAK UNIVERSITY CAMPUS, OPP. BHAGWAT VIDYAPITH, S.G ROAD, GOTTA, AHMEDABAD – 382481, INDIA		
DATE OF REGISTRATION	03/02/2022	
TITLE	AUTOMATIC SOLAR PANEL DUST CLEANING SYSTEM	
PRIORITY NA		
DESIGN NUMBER	357886-001	
CLASS	19-06	
1.DEEPAK SURESH KUMAR R ASSISTANT PROFESSOR, DEPARTMENT OF MECHANICAL ENGINEERING, RAJALAKSHMI INSTITUTE OF TECHNOLOGY, INDIA 2. MOHANRAJ M NO: 14/3, BRS VILLA, 3RD ST, BALAJI NAGAR, KORATTUR, CHENNAI-600 076, INDIA 3. NISHANTH SM 5B, SRI MARUTHI NAGAR, KOZHUMANIVAKKAM, NELLIMANAGAR, MANGADU, CHENNAI-600122, INDIA 4. NISHANT V 365 A 1 VETTAI PERUMAL KOVIL - NORTH, JAI NAGAR, RAJAPALAYAM, VIRUDHUNAGAR DT, 626108, INDIA		
DATE OF REGISTRATION	04/02/2022	
TITLE	DUSTER WITH FLIP FLOP ERASE PAD AND MARKER HOLDER	
PRIORITY NA		



ORIGINAL

No. 112103

भारत सरकार
GOVERNMENT OF INDIA
पेटेंट कार्यालय
THE PATENT OFFICE

CERTIFICATE OF REGISTRATION OF DESIGN

Design No. 357858-001
Date 03/02/2022 19:29:25
Reciprocity Date*
Country

Certified that the design of which a copy is annexed hereto has been registered as of the number and date given above in class 29-02 in respect of the application of such design to ZIP MASK in the name of 1.DR. MAULIK JOSHI, SILVER OAK UNIVERSITY CAMPUS, OPP. BHAGWAT VIDYAPITH, S.G ROAD, GOTA, AHMEDABAD - 382481, INDIA 2. PAYAL DESAI, SILVER OAK UNIVERSITY CAMPUS, OPP. BHAGWAT VIDYAPITH, S.G ROAD, GOTA, AHMEDABAD - 382421, INDIA

in pursuance of and subject to the provisions of the Designs Act, 2000 and the Designs Rules, 2001.

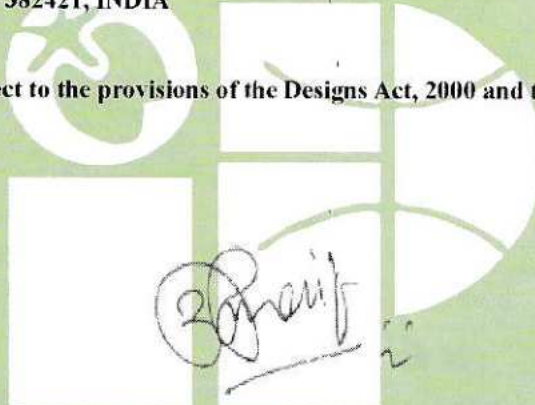

(Handwritten signature)

Controller General of Patents, Designs and Trade Marks

*The reciprocity date (if any) which has been allowed and the name of the country.

Copyright in the design will subsist for ten years from the date of Registration, and may under the terms of the Act and Rules, be extended for a further period of five years.

This Certificate is not for use in legal proceedings or for obtaining registration abroad

MS. DHARTI SHAH,
VERITE ASSOCIATES, 105, SCARLET GATEWAY,
NR. SPIPA ACADEMY, CORPORATE ROAD,
PRAHALADNAGR, AHMEDABAD-380015, GUJARAT,
INDIA

PROPERTY INDIA
PATENTS | DESIGNS | TRADE MARKS
AL INDICATIONS

Date of Issue 25/04/2022 14:22:57

NAME OF THE APPLICANT
DR. MAULIK JOSHI
PAYAL DESAI

NO. OF SHEETS - 3
SHEET NO. - 1

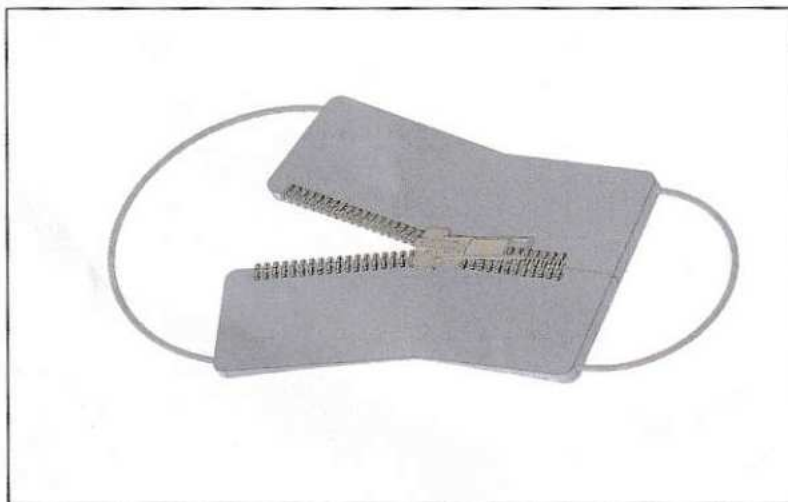

PERSPECTIVE VIEW

The novelty resides in the shape and configuration of the 'ZIP MASK' as illustrated.

No claim is made by virtue of this registration in respect of any mechanical or other action of the mechanism whatever or in respect of any mode or principle of construction of the article.

No claim is made by virtue of the registration to any right to the exclusive use of the words, letters, numbers, colour, combination or Trade Marks as appearing in the representation.

357858-001

03 FEB 2022

Dated this 2nd Day of February 2022.

Ms. DHARTI SHAH
(Authorized Agent of the Applicant)
(IN/PA- 2590)

(REPRESENTATION SHEETS)

NAME OF THE APPLICANT
DR. MAULIK JOSHI
PAYAL DESAI

NO. OF SHEETS - 3
SHEET NO. - 2



FRONT VIEW

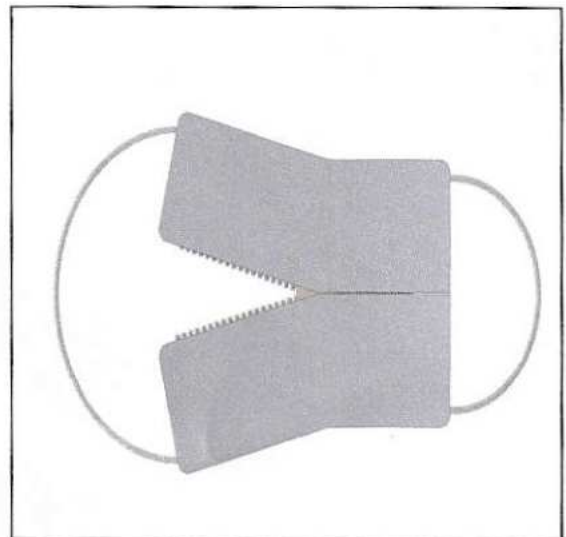

BACK VIEW



TOP VIEW



BOTTOM VIEW

The novelty resides in the shape and configuration of the 'ZIP MASK' as illustrated.

No claim is made by virtue of this registration in respect of any mechanical or other action of the mechanism whatever or in respect of any mode or principle of construction of the article.

No claim is made by virtue of the registration to any right to the exclusive use of the words, letters, numbers, colour, combination or Trade Marks as appearing in the representation.

357858-001

03 FEB 2022

Dated this 2nd Day of February 2022.

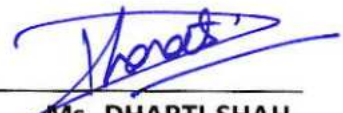
Ms. DHARTI SHAH
(Authorized Agent of the Applicant)
(IN/PA- 2590)

(REPRESENTATION SHEETS)

NAME OF THE APPLICANT
DR. MAULIK JOSHI
PAYAL DESAI

NO. OF SHEETS - 3
SHEET NO. - 3

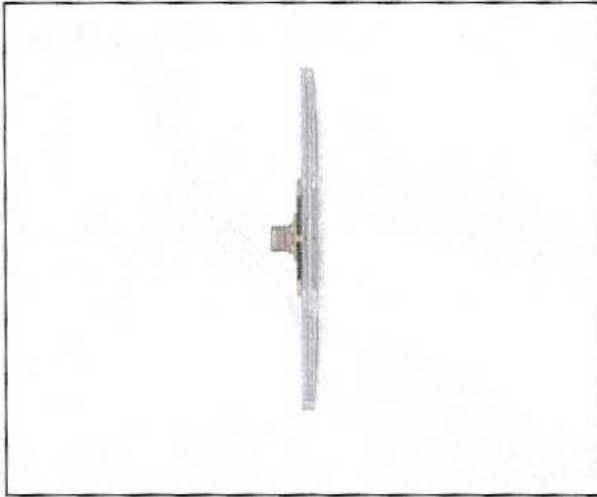

RIGHT SIDE VIEW

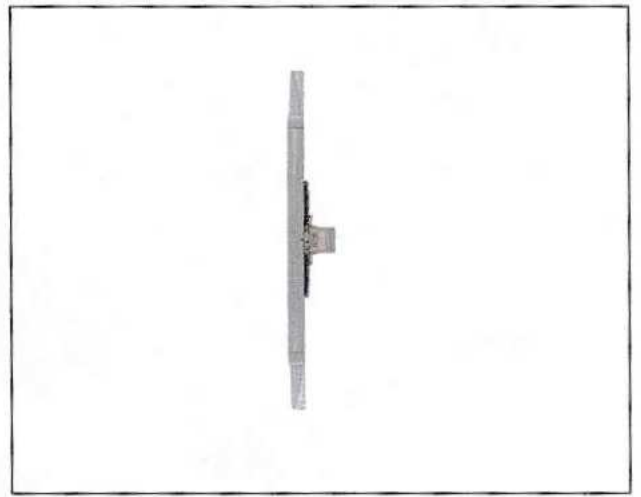

LEFT SIDE VIEW

The novelty resides in the shape and configuration of the 'ZIP MASK' as illustrated.

No claim is made by virtue of this registration in respect of any mechanical or other action of the mechanism whatever or in respect of any mode or principle of construction of the article.



No claim is made by virtue of the registration to any right to the exclusive use of the words, letters, numbers, colour, combination or Trade Marks as appearing in the representation.

357858-001

03 FEB 2022

Dated this 2nd Day of February 2022.

Ms. DHARTI SHAH
(Authorized Agent of the Applicant)
(IN/PA- 2590)

DESIGN NUMBER	357842-006	
CLASS	12-11	
M/S AVON CYCLES LIMITED G. T. ROAD, LUDHIANA-141003, INDIA		
DATE OF REGISTRATION	03/02/2022	
TITLE	CYCLE	
PRIORITY NA		
DESIGN NUMBER	357854-001	
CLASS	25-04	
1.AAKASH BIMAL DESAI SILVER OAK UNIVERSITY CAMPUS, OPP. BHAGWAT VIDYAPITH, S.G ROAD, GOTA, AHMEDABAD – 382481 2. DEVARSH PARIMAL JOSHI SILVER OAK UNIVERSITY CAMPUS, OPP. BHAGWAT VIDYAPITH, S.G ROAD, GOTA, AHMEDABAD – 382481, INDIA		
DATE OF REGISTRATION	03/02/2022	
TITLE	RAIL COACH DOOR FOOT STEP	
PRIORITY NA		
DESIGN NUMBER	357858-001	
CLASS	29-02	
1.DR. MAULIK JOSHI SILVER OAK UNIVERSITY CAMPUS, OPP. BHAGWAT VIDYAPITH, S.G ROAD, GOTA, AHMEDABAD – 382481, INDIA 2. PAYAL DESAI SILVER OAK UNIVERSITY CAMPUS, OPP. BHAGWAT VIDYAPITH, S.G ROAD, GOTA, AHMEDABAD – 382421, INDIA		
DATE OF REGISTRATION	03/02/2022	
TITLE	ZIP MASK	
PRIORITY NA		



ORIGINAL

No. 111757

भारत सरकार
GOVERNMENT OF INDIA
पेटेंट कार्यालय
THE PATENT OFFICE

CERTIFICATE OF REGISTRATION OF DESIGN

Design No. 357859-001
Date 03/02/2022 19:29:25
Reciprocity Date*
Country

Certified that the design of which a copy is annexed hereto has been registered as of the number and date given above in class 03-03 in respect of the application of such design to BMM WALKING STICK WITH UMBRELLA in the name of I.DR. SATVIK KHARA, SILVER OAK UNIVERSITY CAMPUS, OPP. BHAGWAT VIDYAPITH, S.G ROAD, GOTTA, AHMEDABAD – 382481, INDIA 2. PROF. BHARGAV MODI, SILVER OAK UNIVERSITY CAMPUS, OPP. BHAGWAT VIDYAPITH, S.G ROAD, GOTTA, AHMEDABAD – 382481, INDIA 3. PROF. HEMAL PATEL, SILVER OAK UNIVERSITY CAMPUS, OPP. BHAGWAT VIDYAPITH, S.G ROAD, GOTTA, AHMEDABAD – 382481, INDIA 4. PROF. HIMANSHU PRAJAPATI, SILVER OAK UNIVERSITY CAMPUS, OPP. BHAGWAT VIDYAPITH, S.G ROAD, GOTTA, AHMEDABAD – 382481, INDIA

in pursuance of and subject to the provisions of the Designs Act, 2000 and the Designs Rules, 2001.

INTELLECTUAL
Controller General of Patents, Designs and Trade Marks
PROPERTY INDIA

*The reciprocity date (if any) which has been allowed and the name of the country.
Copyright in the design will subsist for ten years from the date of Registration, and may under the terms of the Act and Rules, be extended for a further period of five years.
This Certificate is not for use in legal proceedings or for obtaining registration abroad

MS.DHARTI SHAH,
VERITE ASSOCIATES, 105, SCARLET GATEWAY,
NR. SPIPA ACADEMY, CORPORATE ROAD,
PRAHALADNAGR, AHMEDABAD-380015, GUJARAT,
INDIA

Date of Issue 19/04/2022 14:33:26

(REPRESENTATION SHEETS)

NAME OF THE APPLICANT
DR. SATVIK KHARA
PROF. BHARGAV MODI
PROF. HEMAL PATEL
PROF. HIMANSHU PRAJAPATI

NO. OF SHEETS - 3
SHEET NO. - 1



PERSPECTIVE VIEW

The novelty resides in the shape and configuration of the '**BMM WALKING STICK WITH UMBRELLA**' as illustrated.

No claim is made by virtue of this registration in respect of any mechanical or other action of the mechanism whatever or in respect of any mode or principle of construction of the article.

No claim is made by virtue of the registration to any right to the exclusive use of the words, letters, numbers, colour, combination or Trade Marks as appearing in the representation.

357859-001

03 FEB 2022

Dated this 2nd Day of February 2022.

Ms. DHARTI SHAH
(Authorized Agent of the Applicant)
(IN/PA- 2590)

(REPRESENTATION SHEETS)

NAME OF THE APPLICANT
DR. SATVIK KHARA
PROF. BHARGAV MODI
PROF. HEMAL PATEL
PROF. HIMANSHU PRAJAPATI

NO. OF SHEETS - 3
SHEET NO. - 2



FRONT VIEW



BACK VIEW

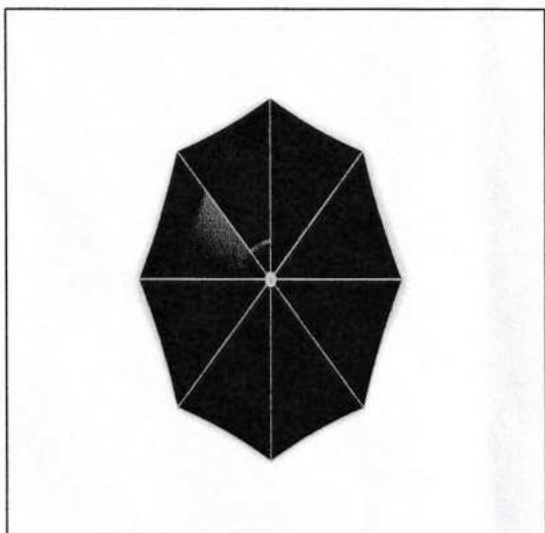

TOP VIEW



BOTTOM VIEW

The novelty resides in the shape and configuration of the 'BMM WALKING STICK WITH UMBRELLA' as illustrated.

No claim is made by virtue of this registration in respect of any mechanical or other action of the mechanism whatever or in respect of any mode or principle of construction of the article.

No claim is made by virtue of the registration to any right to the exclusive use of the words, letters, numbers, colour, combination or Trade Marks as appearing in the representation.

357859-001

03 FEB 2022

Dated this 2nd Day of February 2022.

Ms. DHARTI SHAH
(Authorized Agent of the Applicant)
(IN/PA- 2590)

(REPRESENTATION SHEETS)

NAME OF THE APPLICANT
DR. SATVIK KHARA
PROF. BHARGAV MODI
PROF. HEMAL PATEL
PROF. HIMANSHU PRAJAPATI

NO. OF SHEETS - 3
SHEET NO. - 3



RIGHT SIDE VIEW



LEFT SIDE VIEW

The novelty resides in the shape and configuration of the 'BMM WALKING STICK WITH UMBRELLA' as illustrated.

No claim is made by virtue of this registration in respect of any mechanical or other action of the mechanism whatever or in respect of any mode or principle of construction of the article.

No claim is made by virtue of the registration to any right to the exclusive use of the words, letters, numbers, colour, combination or Trade Marks as appearing in the representation.

357859-001

03 FEB 2022

Dated this 2nd Day of February 2022.

Ms. DHARTI SHAH
(Authorized Agent of the Applicant)
(IN/PA- 2590)

DESIGN NUMBER	357857-001	
CLASS	12-11	
PROF. HARESH RAMANALAL PARMAR SILVER OAK UNIVERSITY CAMPUS, OPP. BHAGWAT VIDYAPITH, S.G ROAD, GOTTA, AHMEDABAD – 382481, INDIA		
DATE OF REGISTRATION	03/02/2022	
TITLE	TWO WHEELER'S DOUBLE STAND	
PRIORITY NA		
DESIGN NUMBER	357859-001	
CLASS	03-03	
1.DR. SATVIK KHARA SILVER OAK UNIVERSITY CAMPUS, OPP. BHAGWAT VIDYAPITH, S.G ROAD, GOTTA, AHMEDABAD – 382481, INDIA 2. PROF. BHARGAV MODI SILVER OAK UNIVERSITY CAMPUS, OPP. BHAGWAT VIDYAPITH, S.G ROAD, GOTTA, AHMEDABAD – 382481, INDIA 3. PROF. HEMAL PATEL SILVER OAK UNIVERSITY CAMPUS, OPP. BHAGWAT VIDYAPITH, S.G ROAD, GOTTA, AHMEDABAD – 382481, INDIA 4. PROF. HIMANSHU PRAJAPATI SILVER OAK UNIVERSITY CAMPUS, OPP. BHAGWAT VIDYAPITH, S.G ROAD, GOTTA, AHMEDABAD – 382481, INDIA		
DATE OF REGISTRATION	03/02/2022	
TITLE	BMM WALKING STICK WITH UMBRELLA	
PRIORITY NA		
DESIGN NUMBER	357871-001	
CLASS	12-05	
1. CT INSTITUTE OF ENGINEERING, MANAGEMENT & TECHNOLOGY PRATHAPURA ROAD, URBAN ESTATE PHASE II, SHAHPUR, PUNJAB-144020, INDIA. 2. AMIT KUMAR CT INSTITUTE OF ENGINEERING, MANAGEMENT & TECHNOLOGY, PRATHAPURA ROAD, URBAN ESTATE PHASE II, SHAHPUR, PUNJAB-144020, INDIA. 3. DR. GUNJAN BHALLA CT INSTITUTE OF ENGINEERING, MANAGEMENT & TECHNOLOGY, PRATHAPURA ROAD, URBAN ESTATE PHASE II, SHAHPUR, PUNJAB-144020, INDIA. 4. IPANDEEP SINGH CT INSTITUTE OF ENGINEERING, MANAGEMENT & TECHNOLOGY, PRATHAPURA ROAD, URBAN ESTATE PHASE II, SHAHPUR, PUNJAB-144020, INDIA. , ET AL.		
DATE OF REGISTRATION	03/02/2022	
TITLE	MOVABLE CARGO LIFTER	
PRIORITY NA		



ORIGINAL

No. 112287

भारत सरकार
GOVERNMENT OF INDIA
पेटेंट कार्यालय
THE PATENT OFFICE

CERTIFICATE OF REGISTRATION OF DESIGN

Design No. 357860-001
Date 03/02/2022 19:29:25
Reciprocity Date*
Country

Certified that the design of which a copy is annexed hereto has been registered as of the number and date given above in class 23-01 in respect of the application of such design to WASTE WATER DISPOSAL DEVICE in the name of 1.PROF. MOHAMMAD IMRAN, SILVER OAK UNIVERSITY CAMPUS, OPP. BHAGWAT VIDYAPITH, S.G ROAD, GOTA, AHMEDABAD – 382421, INDIA. 2. MITESHKUMAR PATEL, SILVER OAK UNIVERSITY CAMPUS, OPP. BHAGWAT VIDYAPITH, S.G ROAD, GOTA, AHMEDABAD – 382421, INDIA.

in pursuance of and subject to the provisions of the Designs Act, 2000 and the Designs Rules, 2001.

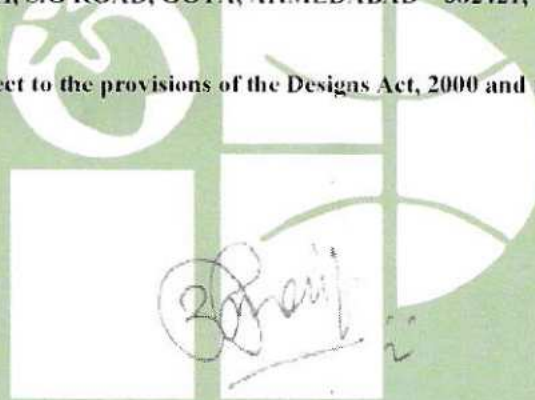

Controller General of Patents, Designs and Trade Marks

*The reciprocity date (if any) which has been allowed and the name of the country.

Copyright in the design will subsist for ten years from the date of Registration, and may under the terms of the Act and Rules, be extended for a further period of five years.

This Certificate is not for use in legal proceedings or for obtaining registration abroad

MS. DHARTI SHAH,
VERITE ASSOCIATES, 105, SCARLET GATEWAY,
NR. SPIPA ACADEMY, CORPORATE ROAD,
PRAHALADNAGR, AHMEDABAD-380015, GUJARAT,
INDIA.

Date of Issue 26/04/2022 11:53:50

PATENTS | DESIGNS | TRADE MARKS
INDIAN PATENT OFFICE
PROPERTY INDIA
AL INDICATIONS

(REPRESENTATION SHEETS)

NAME OF THE APPLICANT
PROF. MOHAMMAD IMRAN
MITESHKUMAR PATEL

NO. OF SHEETS - 3
SHEET NO. - 1

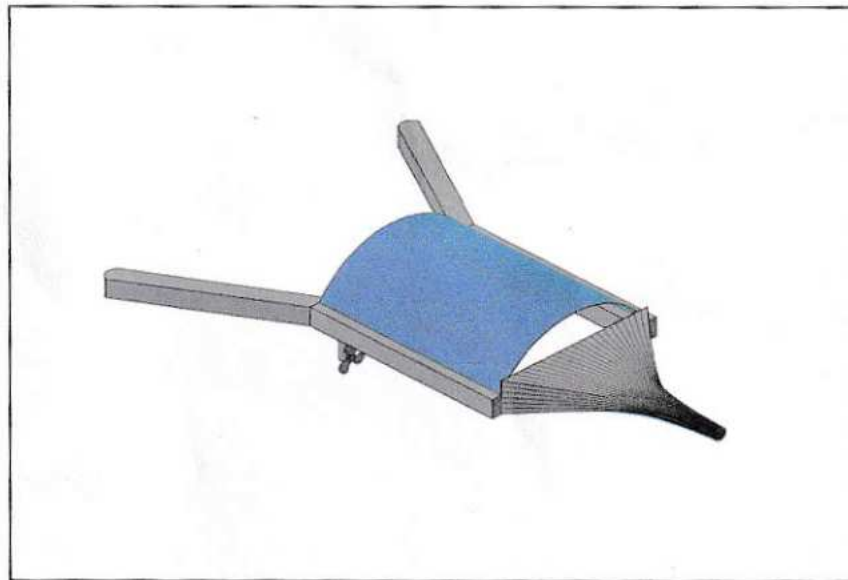

PERSPECTIVE VIEW

The novelty resides in the shape and configuration of the 'WASTE WATER DISPOSAL DEVICE' as illustrated.

No claim is made by virtue of this registration in respect of any mechanical or other action of the mechanism whatever or in respect of any mode or principle of construction of the article.

No claim is made by virtue of the registration to any right to the exclusive use of the words, letters, numbers, colour, combination or Trade Marks as appearing in the representation.

357880 -001

~~04 FEB 2022~~

Dated this 2nd Day of February 2022.

Ms. DHARTI SHAH
(Authorized Agent of the Applicant)
(IN/PA- 2590)

03 FEB 2022

(REPRESENTATION SHEETS)

NAME OF THE APPLICANT
PROF. MOHAMMAD IMRAN
MITESHKUMAR PATEL

NO. OF SHEETS - 3
SHEET NO. - 2

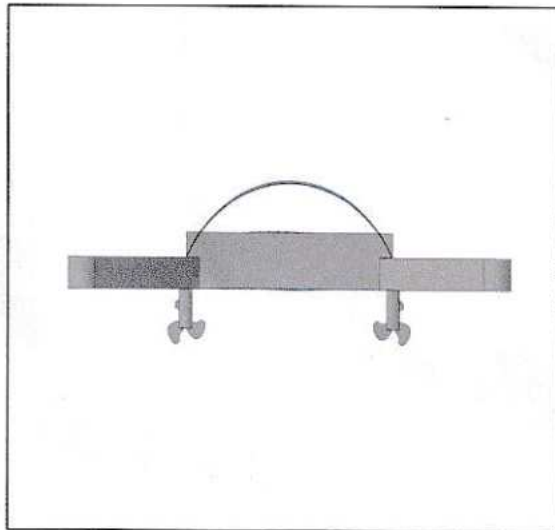

FRONT VIEW

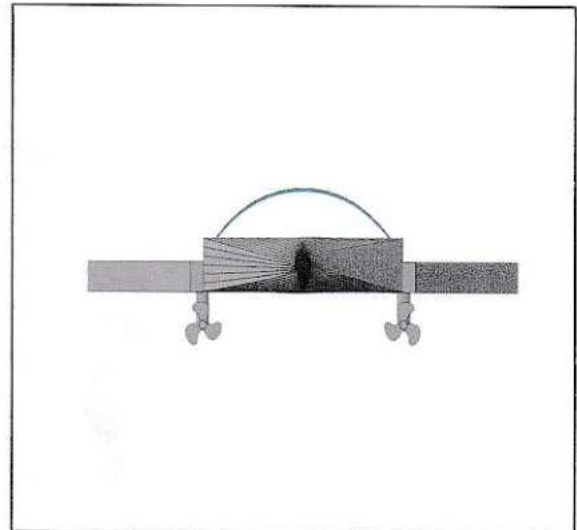

BACK VIEW

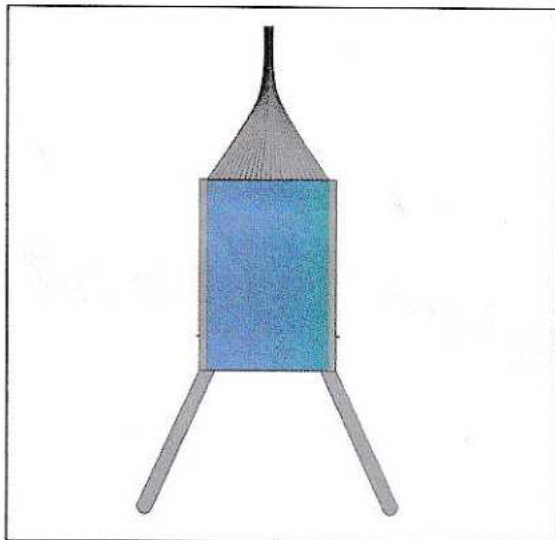

TOP VIEW

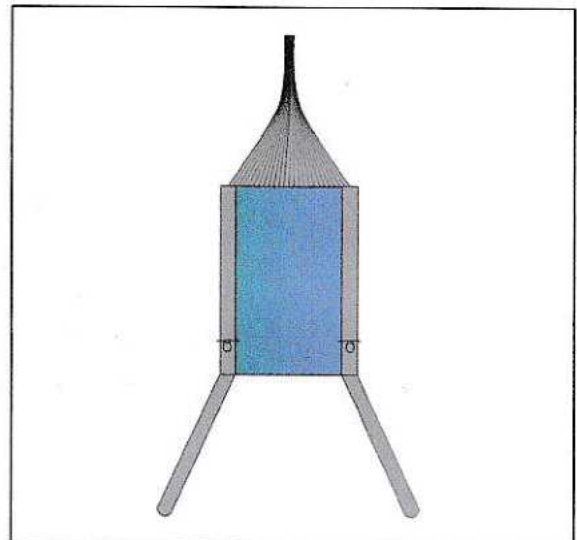

BOTTOM VIEW

The novelty resides in the shape and configuration of the 'WASTE WATER DISPOSAL DEVICE' as illustrated.

No claim is made by virtue of this registration in respect of any mechanical or other action of the mechanism whatever or in respect of any mode or principle of construction of the article.

No claim is made by virtue of the registration to any right to the exclusive use of the words, letters, numbers, colour, combination or Trade Marks as appearing in the representation.

357880 - 001

~~04 FEB 2022~~

Dated this 2nd Day of February 2022.

03 FEB 2022

Ms. DHARTI SHAH
(Authorized Agent of the Applicant)
(IN/PA- 2590)

(REPRESENTATION SHEETS)

NAME OF THE APPLICANT
PROF. MOHAMMAD IMRAN
MITESHKUMAR PATEL

NO. OF SHEETS - 3
SHEET NO. - 3

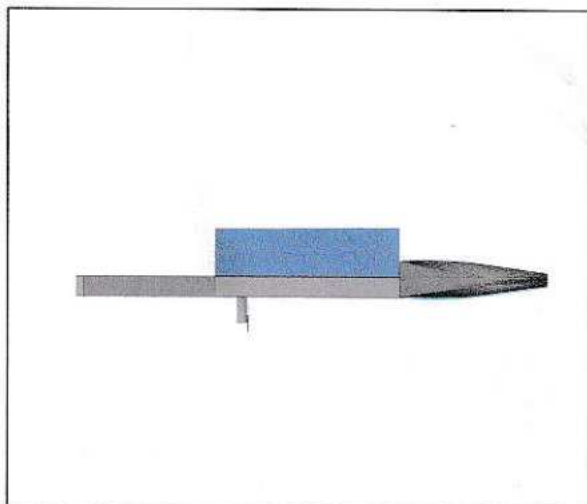

RIGHT SIDE VIEW

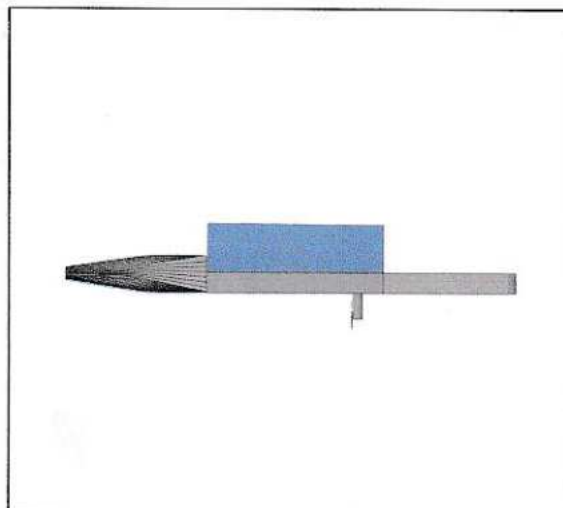

LEFT SIDE VIEW

The novelty resides in the shape and configuration of the 'WASTE WATER DISPOSAL DEVICE' as illustrated.

No claim is made by virtue of this registration in respect of any mechanical or other action of the mechanism whatever or in respect of any mode or principle of construction of the article.



No claim is made by virtue of the registration to any right to the exclusive use of the words, letters, numbers, colour, combination or Trade Marks as appearing in the representation.

357860 -001

03 FEB 2022

Dated this 2nd Day of February 2022.

Ms. DHARTI SHAH
(Authorized Agent of the Applicant)
(IN/PA- 2590)

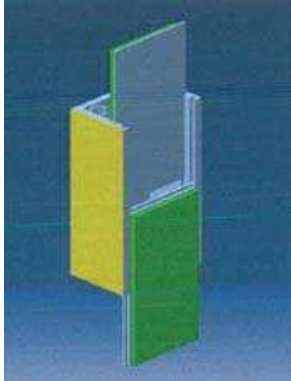
DESIGN NUMBER	357860-001	
CLASS	23-01	
1.PROF. MOHAMMAD IMRAN SILVER OAK UNIVERSITY CAMPUS, OPP. BHAGWAT VIDYAPITH, S.G ROAD, GOTTA, AHMEDABAD – 382421, INDIA. 2. MITESHKUMAR PATEL SILVER OAK UNIVERSITY CAMPUS, OPP. BHAGWAT VIDYAPITH, S.G ROAD, GOTTA, AHMEDABAD – 382421, INDIA.		
DATE OF REGISTRATION	03/02/2022	
TITLE	WASTE WATER DISPOSAL DEVICE	
PRIORITY NA		
DESIGN NUMBER	357863-001	
CLASS	15-05	
1.PROF. MANAN PATHAK SILVER OAK UNIVERSITY CAMPUS, OPP. BHAGWAT VIDYAPITH, S.G ROAD, GOTTA, AHMEDABAD – 382481, INDIA 2. JAY PATEL SILVER OAK UNIVERSITY CAMPUS, OPP. BHAGWAT VIDYAPITH, S.G ROAD, GOTTA, AHMEDABAD – 382481, INDIA 3. SAGAR SONI SILVER OAK UNIVERSITY CAMPUS, OPP. BHAGWAT VIDYAPITH, S.G ROAD, GOTTA, AHMEDABAD – 382481, INDIA		
DATE OF REGISTRATION	03/02/2022	
TITLE	AUTOMATIC SOLAR PANEL DUST CLEANING SYSTEM	
PRIORITY NA		
DESIGN NUMBER	357886-001	
CLASS	19-06	
1.DEEPAK SURESH KUMAR R ASSISTANT PROFESSOR, DEPARTMENT OF MECHANICAL ENGINEERING, RAJALAKSHMI INSTITUTE OF TECHNOLOGY, INDIA 2. MOHANRAJ M NO: 14/3, BRS VILLA, 3RD ST, BALAJI NAGAR, KORATTUR, CHENNAI-600 076, INDIA 3. NISHANTH SM 5B, SRI MARUTHI NAGAR, KOZHUMANIVAKKAM, NELLIMANAGAR, MANGADU, CHENNAI-600122, INDIA 4. NISHANT V 365 A 1 VETTAI PERUMAL KOVIL - NORTH, JAI NAGAR, RAJAPALAYAM, VIRUDHUNAGAR DT, 626108, INDIA		
DATE OF REGISTRATION	04/02/2022	
TITLE	DUSTER WITH FLIP FLOP ERASE PAD AND MARKER HOLDER	
PRIORITY NA		



ORIGINAL

No. 111305

भारत सरकार
GOVERNMENT OF INDIA
पेटेंट कार्यालय
THE PATENT OFFICE

CERTIFICATE OF REGISTRATION OF DESIGN

Design No. 357862-001
Date 03/02/2022 19:29:25
Reciprocity Date*
Country

Certified that the design of which a copy is annexed hereto has been registered as of the number and date given above in class 06-08 in respect of the application of such design to CLOTH HANGER FOR DOORS in the name of 1. KEVAL VIPULKUMAR BHAVSAR, SILVER OAK UNIVERSITY CAMPUS, OPP. BHAGWAT VIDYAPITH, S.G ROAD, GOTTA, AHMEDABAD – 382481, INDIA 2. JAIMIN ALKESHKUMAR PANCHAL, SILVER OAK UNIVERSITY CAMPUS, OPP. BHAGWAT VIDYAPITH, S.G ROAD, GOTTA, AHMEDABAD – 382481, INDIA

in pursuance of and subject to the provisions of the Designs Act, 2000 and the Designs Rules, 2001.

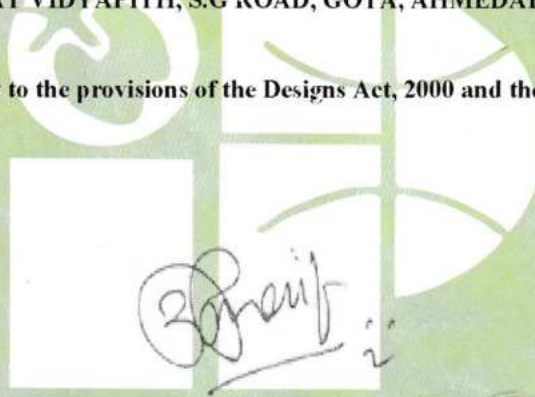

Controller General of Patents, Designs and Trade Marks

*The reciprocity date (if any) which has been allowed and the name of the country.

Copyright in the design will subsist for ten years from the date of Registration, and may under the terms of the Act and Rules, be extended for a further period of five years.

This Certificate is not for use in legal proceedings or for obtaining registration abroad

MS. DHARTI SHAH,
VERITE ASSOCIATES, 105, SCARLET GATEWAY,
NR. SPIPA ACADEMY, CORPORATE ROAD,
PRAHALADNAGR, AHMEDABAD-380015, GUJARAT,
INDIA

Date of Issue 06/04/2022 14:39:29

INTELLECTUAL
PROPERTY INDIA
PATENTS | DESIGNS | TRADE MARKS
GEOGRAPHICAL INDICATIONS

NAME OF THE APPLICANT
KEVAL VIPULKUMAR BHAVSAR
JAIMIN ALKESHKUMAR PANCHAL

NO. OF SHEETS - 3
SHEET NO. - 1

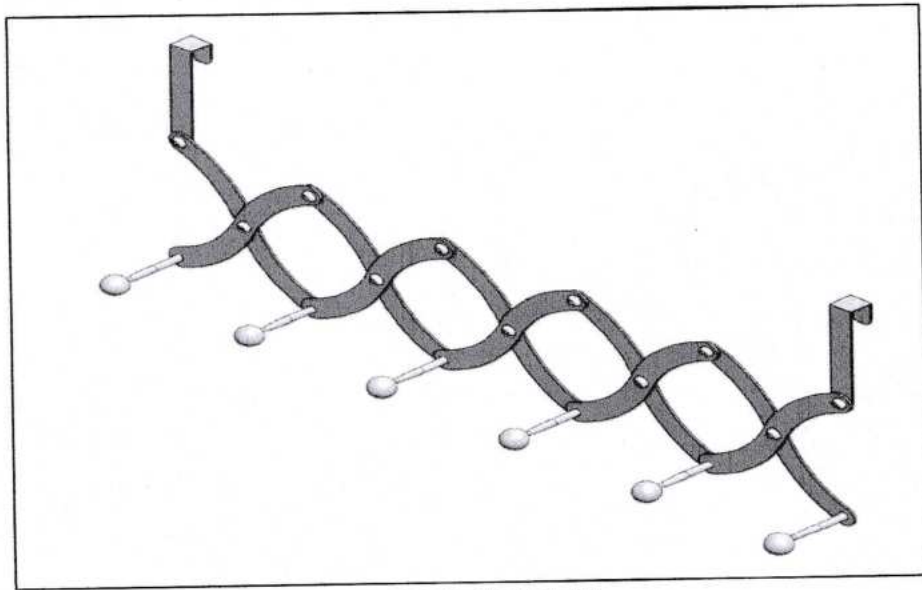

PERSPECTIVE VIEW

The novelty resides in the shape and configuration of the 'CLOTH HANGER FOR DOORS' as illustrated.

No claim is made by virtue of this registration in respect of any mechanical or other action of the mechanism whatever or in respect of any mode or principle of construction of the article.

No claim is made by virtue of the registration to any right to the exclusive use of the words, letters, numbers, colour, combination or Trade Marks as appearing in the representation.

357862-001

03 FEB 2022

Dated this 2nd Day of February 2022.

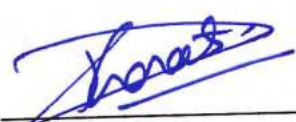

Ms. DHARTI SHAH
(Authorized Agent of the Applicant)
(IN/PA- 2590)

NAME OF THE APPLICANT
KEVAL VIPULKUMAR BHAVSAR
JAIMIN ALKESHKUMAR PANCHAL

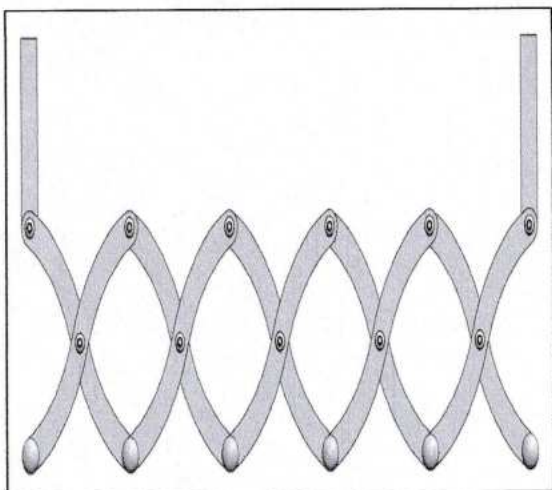
NO. OF SHEETS - 3
SHEET NO. - 2

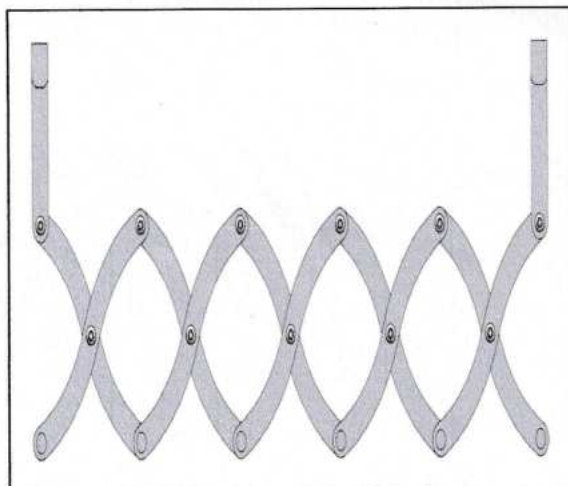

FRONT VIEW



BACK VIEW

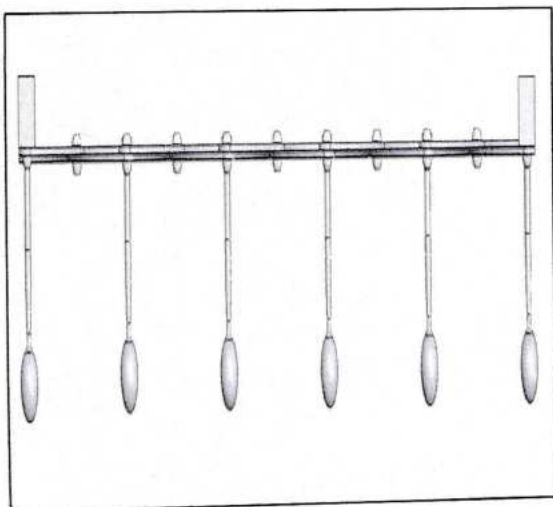

TOP VIEW

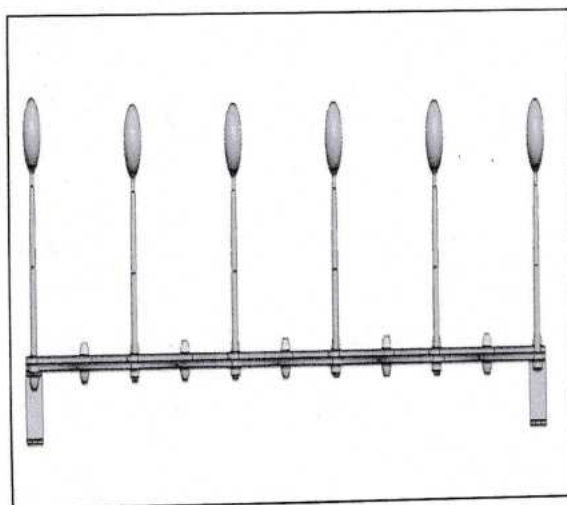

BOTTOM VIEW

The novelty resides in the shape and configuration of the 'CLOTH HANGER FOR DOORS' as illustrated.

No claim is made by virtue of this registration in respect of any mechanical or other action of the mechanism whatever or in respect of any mode or principle of construction of the article.

No claim is made by virtue of the registration to any right to the exclusive use of the words, letters, numbers, colour, combination or Trade Marks as appearing in the representation.

357862-001

03 FEB 2022

Dated this 2nd Day of February 2022.

Ms. DHARTI SHAH
(Authorized Agent of the Applicant)
(IN/PA- 2590)

NAME OF THE APPLICANT
KEVAL VIPULKUMAR BHAVSAR
JAIMIN ALKESHKUMAR PANCHAL

NO. OF SHEETS - 3
SHEET NO. - 3

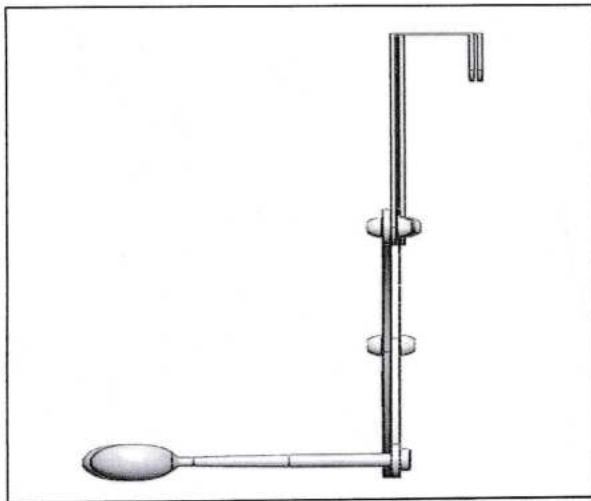

RIGHT SIDE VIEW



LEFT SIDE VIEW

The novelty resides in the shape and configuration of the 'CLOTH HANGER FOR DOORS' as illustrated.

No claim is made by virtue of this registration in respect of any mechanical or other action of the mechanism whatever or in respect of any mode or principle of construction of the article.



No claim is made by virtue of the registration to any right to the exclusive use of the words, letters, numbers, colour, combination or Trade Marks as appearing in the representation.

357862-001

03 FEB 2022

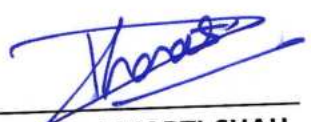
Dated this 2nd Day of February 2022.

Ms. DHARTI SHAH
(Authorized Agent of the Applicant)
(IN/PA- 2590)

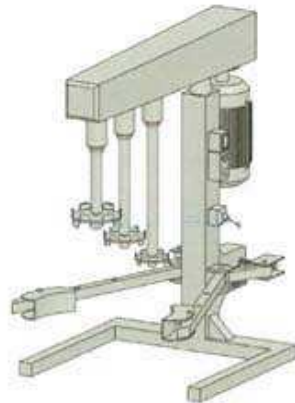
DESIGN NUMBER	357842-005	
CLASS	12-11	
M/S AVON CYCLES LIMITED G. T. ROAD, LUDHIANA-141003, INDIA		
DATE OF REGISTRATION	03/02/2022	
TITLE	CYCLE	
PRIORITY NA		
DESIGN NUMBER	357862-001	
CLASS	06-08	
1. KEVAL VIPULKUMAR BHAVSAR SILVER OAK UNIVERSITY CAMPUS, OPP. BHAGWAT VIDYAPITH, S.G ROAD, GOTA, AHMEDABAD – 382481, INDIA 2. JAIMIN ALKESHKUMAR PANCHAL SILVER OAK UNIVERSITY CAMPUS, OPP. BHAGWAT VIDYAPITH, S.G ROAD, GOTA, AHMEDABAD – 382481, INDIA		
DATE OF REGISTRATION	03/02/2022	
TITLE	CLOTH HANGER FOR DOORS	
PRIORITY NA		
DESIGN NUMBER	357868-001	
CLASS	15-99	
1. CT INSTITUTE OF ENGINEERING, MANAGEMENT & TECHNOLOGY PRATHAPURA ROAD, URBAN ESTATE PHASE II, SHAHPUR, PUNJAB-144020, INDIA. 2. DR. SEWA SINGH CT INSTITUTE OF ENGINEERING, MANAGEMENT & TECHNOLOGY, PRATHAPURA ROAD, URBAN ESTATE PHASE II, SHAHPUR, PUNJAB-144020, INDIA. 3. HARJIT SINGH CT INSTITUTE OF ENGINEERING, MANAGEMENT & TECHNOLOGY, PRATHAPURA ROAD, URBAN ESTATE PHASE II, SHAHPUR, PUNJAB-144020, INDIA. 4. DR. RAHUL MALHOTRA CT INSTITUTE OF ENGINEERING, MANAGEMENT & TECHNOLOGY, PRATHAPURA ROAD, URBAN ESTATE PHASE II, SHAHPUR, PUNJAB-144020, INDIA. , ET AL.		
DATE OF REGISTRATION	03/02/2022	
TITLE	PAINT MIXING MACHINE	
PRIORITY NA		



ORIGINAL

No. 114133

भारत सरकार
GOVERNMENT OF INDIA
पेटेंट कार्यालय
THE PATENT OFFICE

CERTIFICATE OF REGISTRATION OF DESIGN

Design No. 360067-001
Date 07/03/2022 20:38:47
Reciprocity Date*
Country

Certified that the design of which a copy is annexed hereto has been registered as of the number and date given above in class 30-03 in respect of the application of such design to FOOD FEEDING DEVICE FOR BIRDS in the name of 1.MR. YASH MANOJ SAGAR, SILVER OAK UNIVERSITY CAMPUS, OPP. BHAGWAT VIDYAPITH, S.G ROAD, GOTA, AHMEDABAD – 382481, INDIA 2. MR. KEVAL VIPULKUMAR BHAVSAR, SILVER OAK UNIVERSITY CAMPUS, OPP. BHAGWAT VIDYAPITH, S.G ROAD, GOTA, AHMEDABAD – 382481, INDIA 3. MR. UMANG VIJAYKUMAR PARMAR, SILVER OAK UNIVERSITY CAMPUS, OPP. BHAGWAT VIDYAPITH, S.G ROAD, GOTA, AHMEDABAD – 382481, INDIA

in pursuance of and subject to the provisions of the Designs Act, 2000 and the Designs Rules, 2001.

Controller General of Patents, Designs and Trade Marks

*The reciprocity date (if any) which has been allowed and the name of the country.

Copyright in the design will subsist for ten years from the date of Registration, and may under the terms of the Act and Rules, be extended for a further period of five years.

This Certificate is not for use in legal proceedings or for obtaining registration abroad

DHARTI PRAFULKUMAR SHAH,
VERITE ASSOCIATES, 105, SCARLET GATEWAY, NR.
SPIPA ACADEMY, CORPORATE ROAD,
PRAHALADNAGR, AHMEDABAD-380015, GUJARAT,
INDIA

Date of Issue 25/05/2022 13:41:11

(REPRESENTATION SHEETS)

NAME OF THE APPLICANT
MR. YASH MANOJ SAGAR
MR. KEVAL VIPULKUMAR BHAVSAR
MR. UMANG VIJAYKUMAR PARMAR

NO. OF SHEETS - 3
SHEET NO. - 1

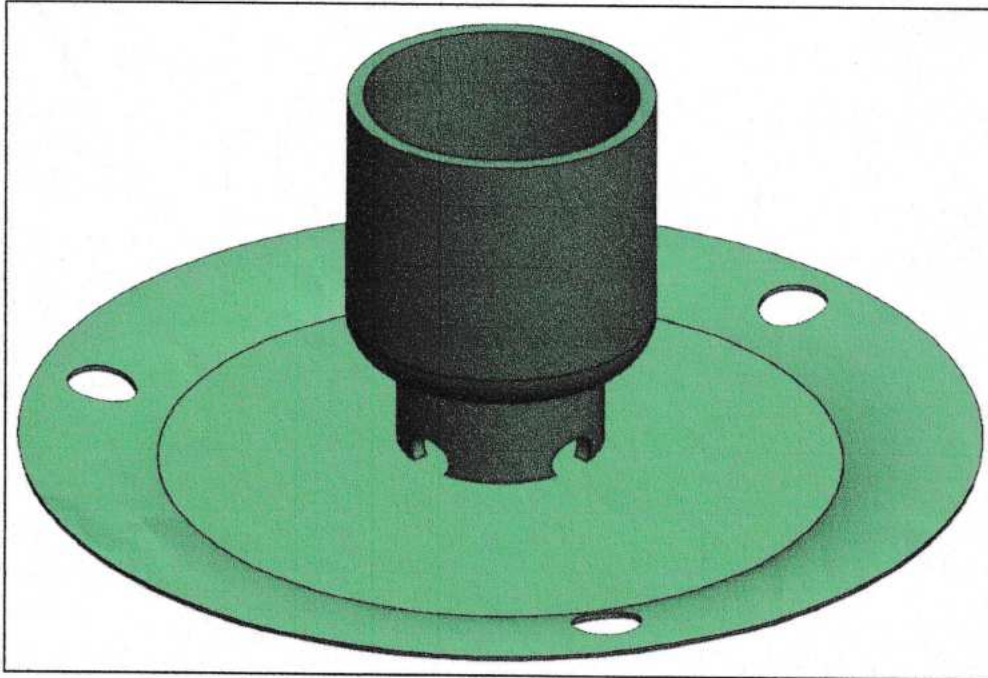

PERSPECTIVE VIEW

The novelty resides in the shape and configuration of the 'FOOD FEEDING DEVICE FOR BIRDS' as illustrated.

No claim is made by virtue of this registration in respect of any mechanical or other action of the mechanism whatever or in respect of any mode or principle of construction of the article.

No claim is made by virtue of the registration to any right to the exclusive use of the words, letters, numbers, colour, combination or Trade Marks as appearing in the representation.

360067-501

07 MAR 2022

Dated this 4th Day of March 2022.

Ms. DHARTI SHAH
(Authorized Agent of the Applicant)
(IN/PA- 2590)

NAME OF THE APPLICANT
MR. YASH MANOJ SAGAR
MR. KEVAL VIPULKUMAR BHAVSAR
MR. UMANG VIJAYKUMAR PARMAR

NO. OF SHEETS - 3
SHEET NO. - 2

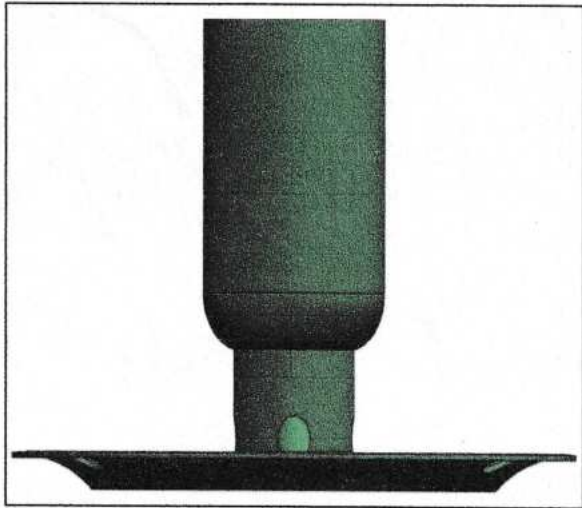

FRONT VIEW

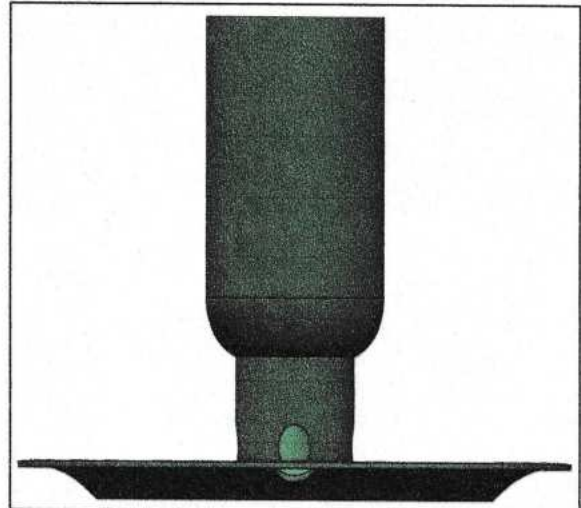

BACK VIEW

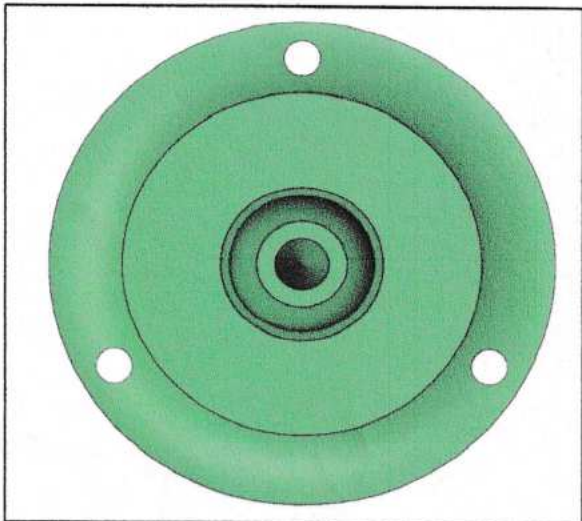

TOP VIEW

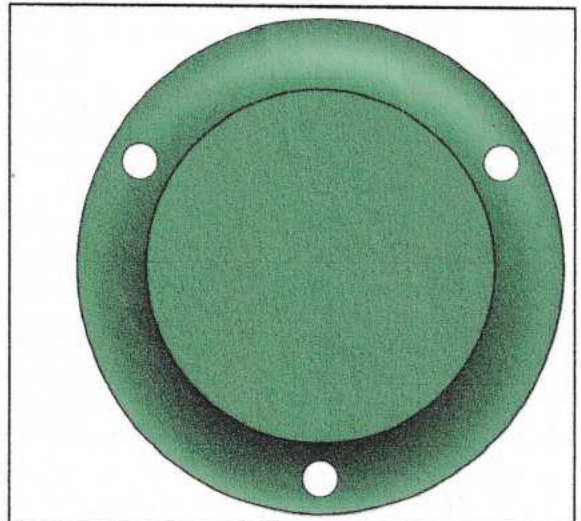

BOTTOM VIEW

The novelty resides in the shape and configuration of the 'FOOD FEEDING DEVICE FOR BIRDS' as illustrated.

No claim is made by virtue of this registration in respect of any mechanical or other action of the mechanism whatever or in respect of any mode or principle of construction of the article.

No claim is made by virtue of the registration to any right to the exclusive use of the words, letters, numbers, colour, combination or Trade Marks as appearing in the representation.

360067-001

07 MAR 2022

Dated this 4th Day of March 2022.

Ms. DHARTI SHAH
(Authorized Agent of the Applicant)
(IN/PA- 2590)

(REPRESENTATION SHEETS)

NAME OF THE APPLICANT
MR. YASH MANOJ SAGAR
MR. KEVAL VIPULKUMAR BHAVSAR
MR. UMANG VIJAYKUMAR PARMAR

NO. OF SHEETS - 3
SHEET NO. - 3

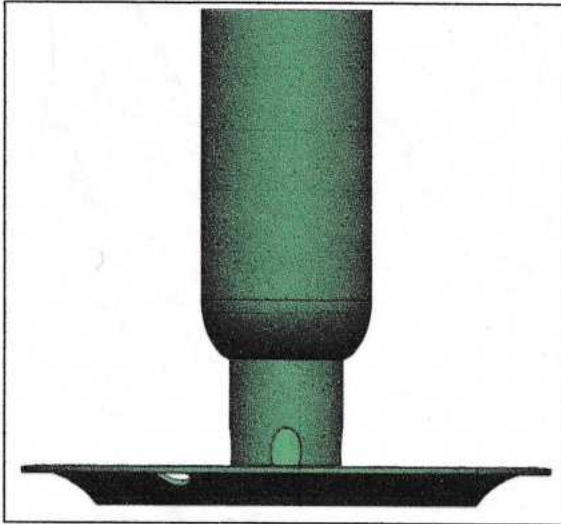

RIGHT SIDE VIEW

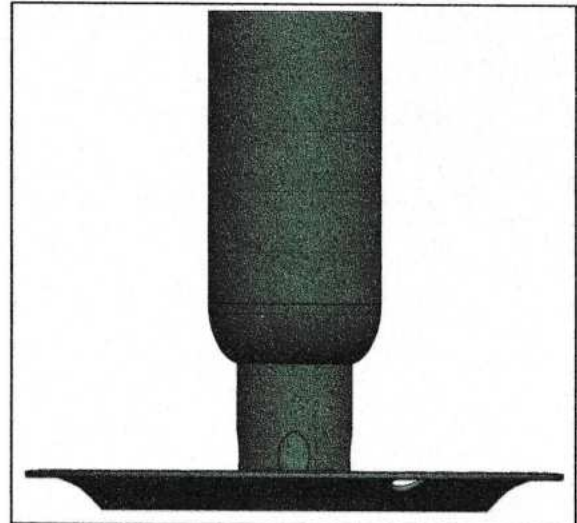

LEFT SIDE VIEW

The novelty resides in the shape and configuration of the 'FOOD FEEDING DEVICE FOR BIRDS' as illustrated.

No claim is made by virtue of this registration in respect of any mechanical or other action of the mechanism whatever or in respect of any mode or principle of construction of the article.



No claim is made by virtue of the registration to any right to the exclusive use of the words, letters, numbers, colour, combination or Trade Marks as appearing in the representation.

360067-501

07 MAR 2022

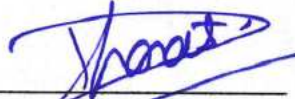
Dated this 4th Day of March 2022.

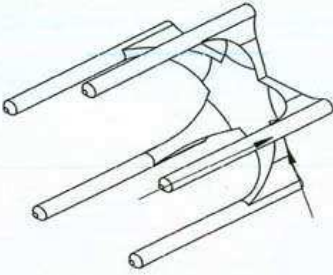
Ms. DHARTI SHAH
(Authorized Agent of the Applicant)
(IN/PA- 2590)

DESIGN NUMBER	360067-001	
CLASS	30-03	
1.MR. YASH MANOJ SAGAR SILVER OAK UNIVERSITY CAMPUS, OPP. BHAGWAT VIDYAPITH, S.G ROAD, GOTTA, AHMEDABAD – 382481, INDIA 2. MR. KEVAL VIPULKUMAR BHAVSAR SILVER OAK UNIVERSITY CAMPUS, OPP. BHAGWAT VIDYAPITH, S.G ROAD, GOTTA, AHMEDABAD – 382481, INDIA 3. MR. UMANG VIJAYKUMAR PARMAR SILVER OAK UNIVERSITY CAMPUS, OPP. BHAGWAT VIDYAPITH, S.G ROAD, GOTTA, AHMEDABAD – 382481, INDIA		
DATE OF REGISTRATION	07/03/2022	
TITLE	FOOD FEEDING DEVICE FOR BIRDS	
PRIORITY NA		
DESIGN NUMBER	360089-001	
CLASS	07-99	
1.B PON MITHRESH AUTOMOBILE ENGINEERING, BANNARI AMMAN INSTITUTE OF TECHNOLOGY, SATHYAMANGALAM, ERODE, TAMILNADU-638401 2. R S AJAY RAAJ AUTOMOBILE ENGINEERING, BANNARI AMMAN INSTITUTE OF TECHNOLOGY, SATHYAMANGALAM, ERODE, TAMILNADU-638401 3. A SURYA PRAKASH AUTOMOBILE ENGINEERING, BANNARI AMMAN INSTITUTE OF TECHNOLOGY, SATHYAMANGALAM, ERODE, TAMILNADU-638401 4. M VASANTHASUDAR AUTOMOBILE ENGINEERING, BANNARI AMMAN INSTITUTE OF TECHNOLOGY, SATHYAMANGALAM, ERODE, TAMILNADU-638401		
DATE OF REGISTRATION	08/03/2022	
TITLE	PIZZA TOPPING COVER	
PRIORITY NA		
DESIGN NUMBER	360091-001	
CLASS	31-00	
MR. DINESH JAIN C-22, ROOM NO.4, ROAD NO.6, PARK SITE, VIKHROLI (WEST), MUMBAI – 400079. INDIA		
DATE OF REGISTRATION	08/03/2022	
TITLE	MIXTURE AND GRINDER	
PRIORITY NA		



ORIGINAL

No. 113788

भारत सरकार
GOVERNMENT OF INDIA
पेटेंट कार्यालय
THE PATENT OFFICE

CERTIFICATE OF REGISTRATION OF DESIGN

Design No. 360068-001
Date 07/03/2022 20:38:47
Reciprocity Date*
Country

Certified that the design of which a copy is annexed hereto has been registered as of the number and date given above in class 06-03 in respect of the application of such design to PORTABLE MOBILE PHONE HOLDER WITH WRITING DESK in the name of 1.MR. DEVANSH SHAILESHBHAI SHAH, SILVER OAK UNIVERSITY CAMPUS, OPP. BHAGWAT VIDYAPITH, S.G ROAD, GOTA, AHMEDABAD – 382481 2. MR. KEVAL VIPULKUMAR BHAVSAR, SILVER OAK UNIVERSITY CAMPUS, OPP. BHAGWAT VIDYAPITH, S.G ROAD, GOTA, AHMEDABAD – 382481 3. MR.UMANG VIJAYKUMAR PARMAR, SILVER OAK UNIVERSITY CAMPUS, OPP. BHAGWAT VIDYAPITH, S.G ROAD, GOTA, AHMEDABAD – 382481

in pursuance of and subject to the provisions of the Designs Act, 2000 and the Designs Rules, 2001.

Controller General of Patents, Designs and Trade Marks

*The reciprocity date (if any) which has been allowed and the name of the country.

Copyright in the design will subsist for ten years from the date of Registration, and may under the terms of the Act and Rules, be extended for a further period of five years.

This Certificate is not for use in legal proceedings or for obtaining registration abroad

MS. DHARTI SHAH,
VERITE ASSOCIATES, 105, SCARLET GATEWAY, NR.
SPIPA ACADEMY, CORPORATE ROAD,
PRAHALADNAGR, AHMEDABAD-380015, GUJARAT,
INDIA

Date of Issue 18/05/2022 11:50:18

PROPERTY INDIA
PATENTS | DESIGNS | TRADE MARKS
APPROVAL INDICATIONS

(REPRESENTATION SHEETS)

NAME OF THE APPLICANT

MR. DEVANSH SHAILESHBHAI SHAH

MR. KEVAL VIPULKUMAR BHAVSAR

MR. UMANG VIJAYKUMAR PARMAR

NO. OF SHEETS - 3

SHEET NO. - 1



PERSPECTIVE VIEW

The novelty resides in the shape and configuration of the '**PORTABLE MOBILE PHONE HOLDER WITH WRITING DESK**' as illustrated.

No claim is made by virtue of this registration in respect of any mechanical or other action of the mechanism whatever or in respect of any mode or principle of construction of the article.

No claim is made by virtue of the registration to any right to the exclusive use of the words, letters, numbers, colour, combination or Trade Marks as appearing in the representation.

360068-001

07 MAR 2022

Dated this 4th Day of March 2022.

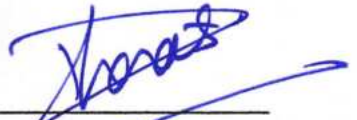
Ms. DHARTI SHAH
(Authorized Agent of the Applicant)
(IN/PA- 2590)

(REPRESENTATION SHEETS)

NAME OF THE APPLICANT
MR. DEVANSH SHAILESHBHAJ SHAH
MR. KEVAL VIPULKUMAR BHAVSAR
MR. UMANG VIJAYKUMAR PARMAR

NO. OF SHEETS - 3
SHEET NO. - 2

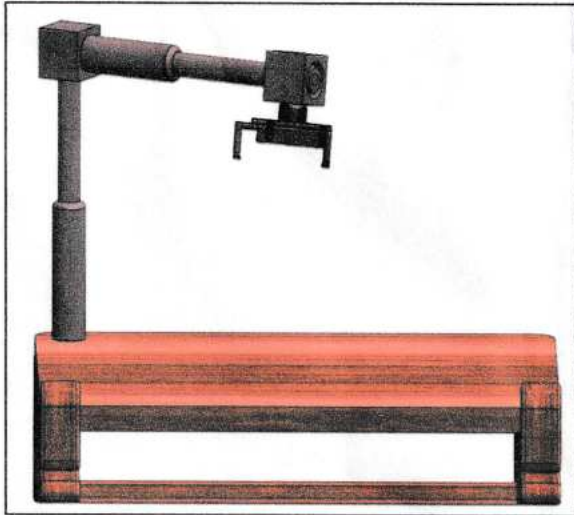

FRONT VIEW

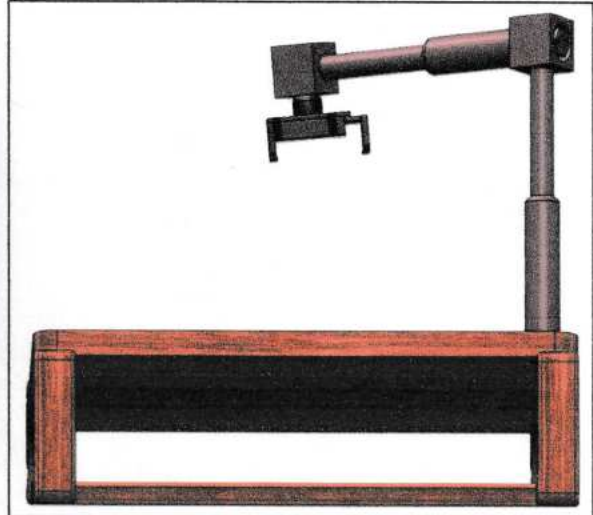

BACK VIEW

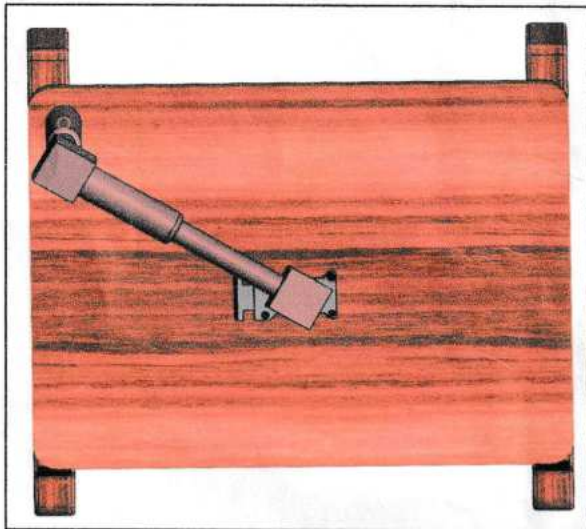

TOP VIEW

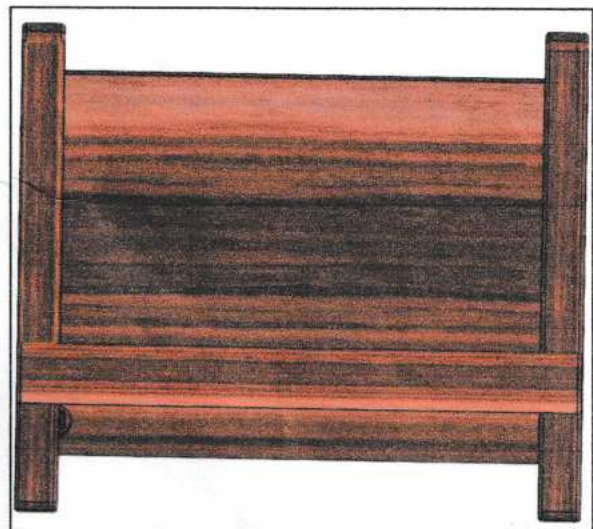

BOTTOM VIEW

The novelty resides in the shape and configuration of the 'PORTABLE MOBILE PHONE HOLDER WITH WRITING DESK' as illustrated.

No claim is made by virtue of this registration in respect of any mechanical or other action of the mechanism whatever or in respect of any mode or principle of construction of the article.

No claim is made by virtue of the registration to any right to the exclusive use of the words, letters, numbers, colour, combination or Trade Marks as appearing in the representation.

360088-501

07 MAR 2022

Dated this 4th Day of March 2022.

MS. DHARTI SHAH
(Authorized Agent of the Applicant)
(IN/PA- 2590)

(REPRESENTATION SHEETS)

NAME OF THE APPLICANT
MR. DEVANSH SHAILESHBHAJ SHAH
MR. KEVAL VIPULKUMAR BHAVSAR
MR. UMANG VIJAYKUMAR PARMAR

NO. OF SHEETS - 3
SHEET NO. - 3

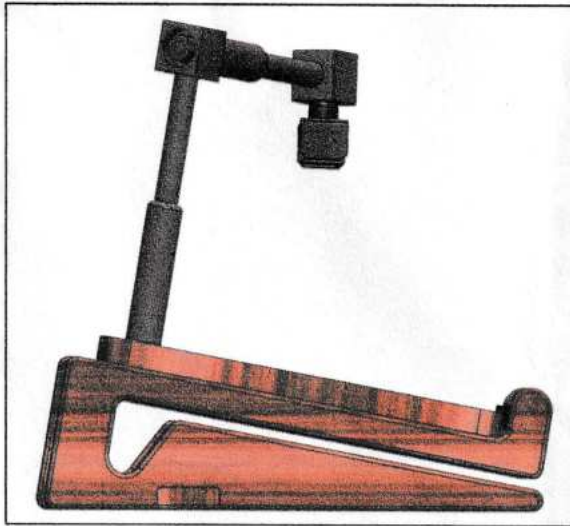

LEFT SIDE VIEW

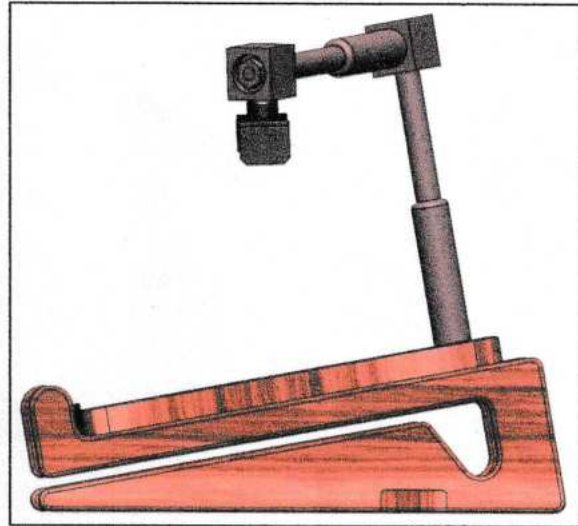

RIGHT SIDE VIEW

The novelty resides in the shape and configuration of the 'PORTABLE MOBILE PHONE HOLDER WITH WRITING DESK' as illustrated.

No claim is made by virtue of this registration in respect of any mechanical or other action of the mechanism whatever or in respect of any mode or principle of construction of the article.



No claim is made by virtue of the registration to any right to the exclusive use of the words, letters, numbers, colour, combination or Trade Marks as appearing in the representation.

360068-501

07 MAR 2022

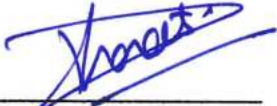
Dated this 4th Day of March 2022.

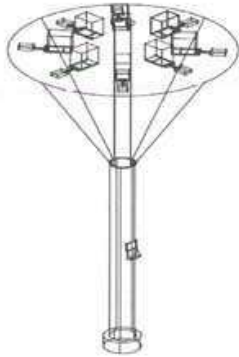
Ms. DHARTI SHAH
(Authorized Agent of the Applicant)
(IN/PA- 2590)

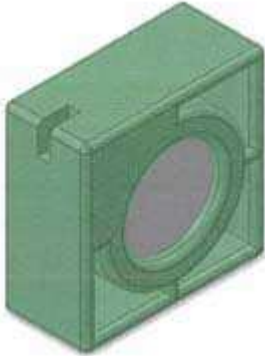
DESIGN NUMBER	360066-001	
CLASS	24-02	
1.MR. SIDDHARTH KURMI SILVER OAK UNIVERSITY CAMPUS, OPP. BHAGWAT VIDYAPITH, S.G ROAD, GOTA, AHMEDABAD – 382481 2. MR. NOEL GEO MATHEWS SILVER OAK UNIVERSITY CAMPUS, OPP. BHAGWAT VIDYAPITH, S.G ROAD, GOTA, AHMEDABAD – 382481 3. MR. ANIKET GUPTA SILVER OAK UNIVERSITY CAMPUS, OPP. BHAGWAT VIDYAPITH, S.G ROAD, GOTA, AHMEDABAD – 382481 4. MR. DEVANSHU JADOUN SILVER OAK UNIVERSITY CAMPUS, OPP. BHAGWAT VIDYAPITH, S.G ROAD, GOTA, AHMEDABAD – 382481 , ET AL.		
DATE OF REGISTRATION	07/03/2022	
TITLE	MEDBAY	
PRIORITY NA		
DESIGN NUMBER	360068-001	
CLASS	06-03	
1.MR. DEVANSH SHAILESHBHAI SHAH SILVER OAK UNIVERSITY CAMPUS, OPP. BHAGWAT VIDYAPITH, S.G ROAD, GOTA, AHMEDABAD – 382481 2. MR. KEVAL VIPULKUMAR BHAVSAR SILVER OAK UNIVERSITY CAMPUS, OPP. BHAGWAT VIDYAPITH, S.G ROAD, GOTA, AHMEDABAD – 382481 3. MR.UMANG VIJAYKUMAR PARMAR SILVER OAK UNIVERSITY CAMPUS, OPP. BHAGWAT VIDYAPITH, S.G ROAD, GOTA, AHMEDABAD – 382481		
DATE OF REGISTRATION	07/03/2022	
TITLE	PORTABLE MOBILE PHONE HOLDER WITH WRITING DESK	
PRIORITY NA		
DESIGN NUMBER	360075-001	
CLASS	09-09	
1.PROF. MANAN PATHAK SILVER OAK UNIVERSITY CAMPUS, OPP. BHAGWAT VIDYAPITH, S.G ROAD, GOTA, AHMEDABAD – 382481, INDIA 2. MR. JAY PATEL SILVER OAK UNIVERSITY CAMPUS, OPP. BHAGWAT VIDYAPITH, S.G ROAD, GOTA, AHMEDABAD – 382481, INDIA 3. MR. SAGAR SONI SILVER OAK UNIVERSITY CAMPUS, OPP. BHAGWAT VIDYAPITH, S.G ROAD, GOTA, AHMEDABAD – 382481, INDIA		
DATE OF REGISTRATION	07/03/2022	
TITLE	SMART PLASTIC WASTE MANAGEMENT SYSTEM	
PRIORITY NA		



ORIGINAL

No. 113254

भारत सरकार
GOVERNMENT OF INDIA
पेटेंट कार्यालय
THE PATENT OFFICE

CERTIFICATE OF REGISTRATION OF DESIGN

Design No. 360073-001
Date 07/03/2022 20:38:47
Reciprocity Date*
Country

Certified that the design of which a copy is annexed hereto has been registered as of the number and date given above in class 07-09 in respect of the application of such design to MULTI DIMENSION CUP HOLDER in the name of 1.MR. KEVAL VIPULKUMAR BHAVSAR, SILVER OAK UNIVERSITY CAMPUS, OPP. BHAGWAT VIDYAPITH, S.G ROAD, GOTA, AHMEDABAD - 382481 2. MR. DEVANSH SHAILESHBHAJ SHAH, SILVER OAK UNIVERSITY CAMPUS, OPP. BHAGWAT VIDYAPITH, S.G ROAD, GOTA, AHMEDABAD - 382481 3. MR. SMIT JITENDRABHAI PANCHASARA, SILVER OAK UNIVERSITY CAMPUS, OPP. BHAGWAT VIDYAPITH, S.G ROAD, GOTA, AHMEDABAD - 382481 4. MR. UMANG VIJAYKUMAR PARMAR, SILVER OAK UNIVERSITY CAMPUS, OPP. BHAGWAT VIDYAPITH, S.G ROAD, GOTA, AHMEDABAD - 382481

in pursuance of and subject to the provisions of the Designs Act, 2000 and the Designs Rules, 2001.

INTELLECTUAL
PROPERTY INDIA
DESIGNS & TRADE MARKS
INDICATIONS
Controller General of Patents, Designs and Trade Marks

*The reciprocity date (if any) which has been allowed and the name of the country.

Copyright in the design will subsist for ten years from the date of Registration, and may under the terms of the Act and Rules, be extended for a further period of five years.

This Certificate is not for use in legal proceedings or for obtaining registration abroad

MS. DHARTI SHAH,
VERITE ASSOCIATES, 105 SCARLET GATEWAY,
NR. SPIPA ACADEMY, CORPORATE ROAD,
PRAHLADNAGAR, AHMEDABAD-380015, GUJARAT,
INDIA

Date of Issue 09/05/2022 14:53:04

(REPRESENTATION SHEETS)

NAME OF THE APPLICANT

MR. KEVAL VIPULKUMAR BHAVSAR

MR. DEVANSH SHAILESHBHAI SHAH

MR. SMIT JITENDRABHAI PANCHASARA

MR. UMANG VIJAYKUMAR PARMAR

NO. OF SHEETS - 3

SHEET NO. - 1



PERSPECTIVE VIEW

The novelty resides in the shape and configuration of the 'MULTI DIMENSION CUP HOLDER' as illustrated.

No claim is made by virtue of this registration in respect of any mechanical or other action of the mechanism whatever or in respect of any mode or principle of construction of the article.

No claim is made by virtue of the registration to any right to the exclusive use of the words, letters, numbers, colour, combination or Trade Marks as appearing in the representation.

360073-001

07 MAR 2022

Dated this 4th Day of March 2022.

Ms. DHARTI SHAH
(Authorized Agent of the Applicant)
(IN/PA- 2590)

(REPRESENTATION SHEETS)

NAME OF THE APPLICANT

MR. KEVAL VIPULKUMAR BHAVSAR

MR. DEVANSH SHAILESHBHAJ SHAH

MR. SMIT JITENDRABHAI PANCHASARA

MR. UMANG VIJAYKUMAR PARMAR

NO. OF SHEETS - 3

SHEET NO. - 2

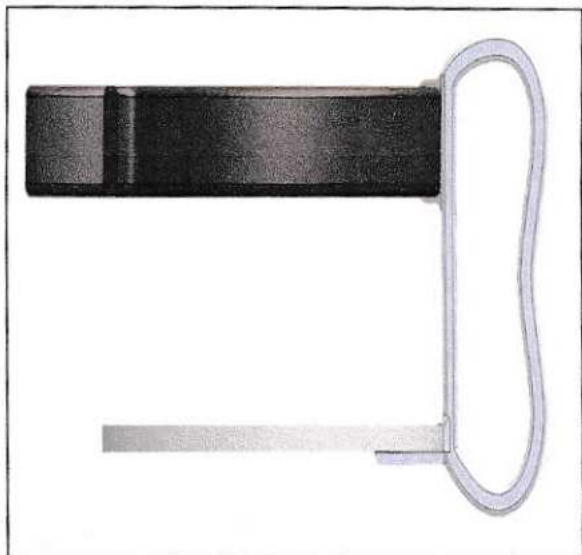

FRONT VIEW

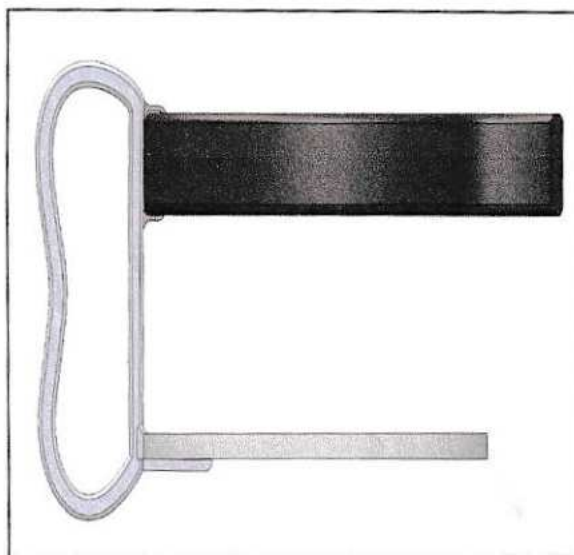

BACK VIEW

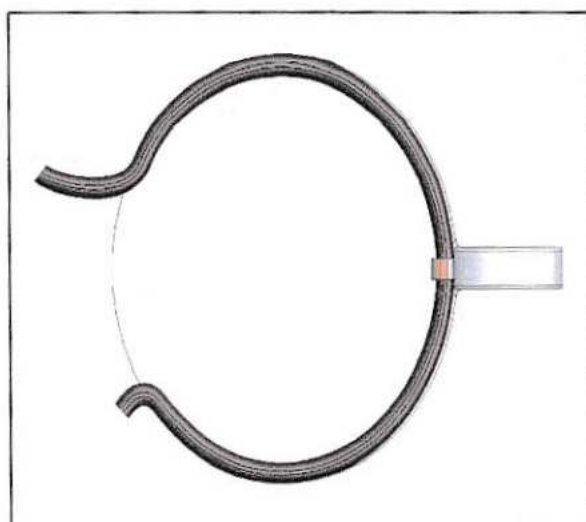

TOP VIEW

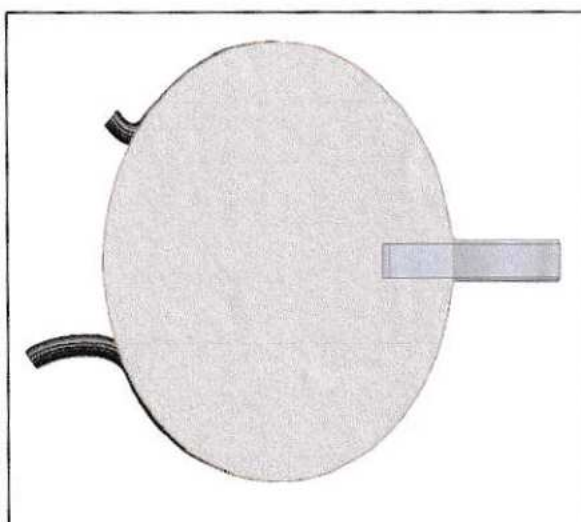

BOTTOM VIEW

The novelty resides in the shape and configuration of the 'MULTI DIMENSION CUP HOLDER' as illustrated.

No claim is made by virtue of this registration in respect of any mechanical or other action of the mechanism whatever or in respect of any mode or principle of construction of the article.

No claim is made by virtue of the registration to any right to the exclusive use of the words, letters, numbers, colour, combination or Trade Marks as appearing in the representation.

360073-001

07 MAR 2022

Dated this 4th Day of March 2022.

Ms. DHARTI SHAH
(Authorized Agent of the Applicant)
(IN/PA- 2590)

(REPRESENTATION SHEETS)

NAME OF THE APPLICANT

MR. KEVAL VIPULKUMAR BHAVSAR

MR. DEVANSH SHAILESHBHAJ SHAH

MR. SMIT JITENDRABHAI PANCHASARA

MR. UMANG VIJAYKUMAR PARMAR

NO. OF SHEETS - 3

SHEET NO. - 3

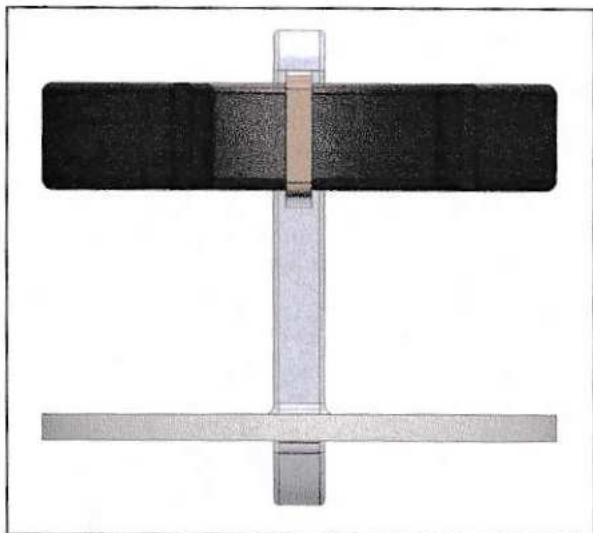

LEFT SIDE VIEW

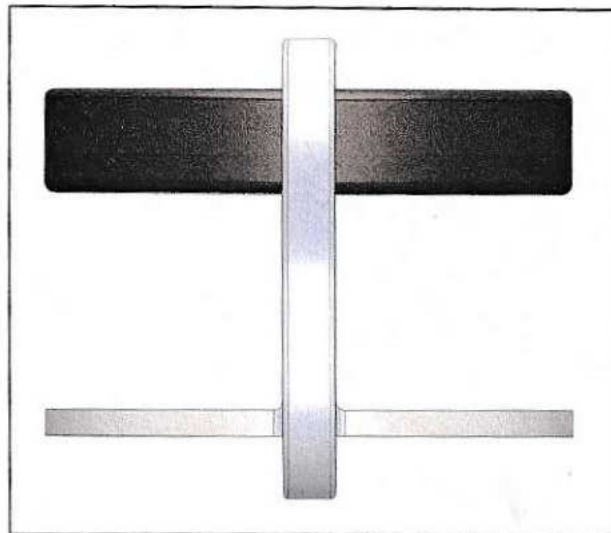

RIGHT SIDE VIEW

The novelty resides in the shape and configuration of the 'MULTI DIMENSION CUP HOLDER' as illustrated.

No claim is made by virtue of this registration in respect of any mechanical or other action of the mechanism whatever or in respect of any mode or principle of construction of the article.



No claim is made by virtue of the registration to any right to the exclusive use of the words, letters, numbers, colour, combination or Trade Marks as appearing in the representation.

360073 - 001

07 MAR 2022

Dated this 4th Day of March 2022.

Ms. DHARTI SHAH
(Authorized Agent of the Applicant)
(IN/PA- 2590)

DESIGN NUMBER	360033-001	
CLASS	02-02	
MEHULBHAI JAYANTIBHAI AKOLIYA I/301, SILVER NEST, NEAR DEVI DARSHAN SOCIETY, YOGICHOWK, SURAT-395010, INDIA		
DATE OF REGISTRATION	07/03/2022	
TITLE	LADIES GARMENT SET	
PRIORITY NA		
DESIGN NUMBER	360073-001	
CLASS	07-09	
1.MR. KEVAL VIPULKUMAR BHAVSAR SILVER OAK UNIVERSITY CAMPUS, OPP. BHAGWAT VIDYAPITH, S.G ROAD, GOTA, AHMEDABAD – 382481 2. MR. DEVANSH SHAILESHBHAI SHAH SILVER OAK UNIVERSITY CAMPUS, OPP. BHAGWAT VIDYAPITH, S.G ROAD, GOTA, AHMEDABAD – 382481 3. MR. SMIT JITENDRABHAI PANCHASARA SILVER OAK UNIVERSITY CAMPUS, OPP. BHAGWAT VIDYAPITH, S.G ROAD, GOTA, AHMEDABAD – 382481 4. MR. UMANG VIJAYKUMAR PARMAR SILVER OAK UNIVERSITY CAMPUS, OPP. BHAGWAT VIDYAPITH, S.G ROAD, GOTA, AHMEDABAD – 382481		
DATE OF REGISTRATION	07/03/2022	
TITLE	MULTI DIMENSION CUP HOLDER	
PRIORITY NA		
DESIGN NUMBER	360096-003	
CLASS	07-02	
ALKON PLASTICS PVT. LTD. 801, 8TH FLOOR, EMBASSY CHAMBERS, 3RD ROAD, KHAR (WEST), MUMBAI : 400052, MAHARASHTRA, INDIA		
DATE OF REGISTRATION	08/03/2022	
TITLE	PLASTIC TILTING STORAGE CONTAINER-4	
PRIORITY NA		



ORIGINAL

No. 107492

भारत सरकार
GOVERNMENT OF INDIA
पेटेंट कार्यालय
THE PATENT OFFICE

CERTIFICATE OF REGISTRATION OF DESIGN

Design No. 353744-001
Date 26/11/2021 16:11:15
Reciprocity Date*
Country

Certified that the design of which a copy is annexed hereto has been registered as of the number and date given above in class 13-04 in respect of the application of such design to WALL MOUNTED ACTIVE SOLAR TRACKER in the name of I.NIHAR V. RAVAL, SILVER OAK UNIVERSITY CAMPUS, OPP. BHAGWAT VIDYAPITH, S.G ROAD, GOTA, AHMEDABAD – 382481, INDIA 2. VEDKUMAR NARESHBHAI PATEL, SILVER OAK UNIVERSITY CAMPUS, OPP. BHAGWAT VIDYAPITH, S.G ROAD, GOTA, AHMEDABAD – 382481, INDIA

in pursuance of and subject to the provisions of the Designs Act, 2000 and the Designs Rules, 2001.

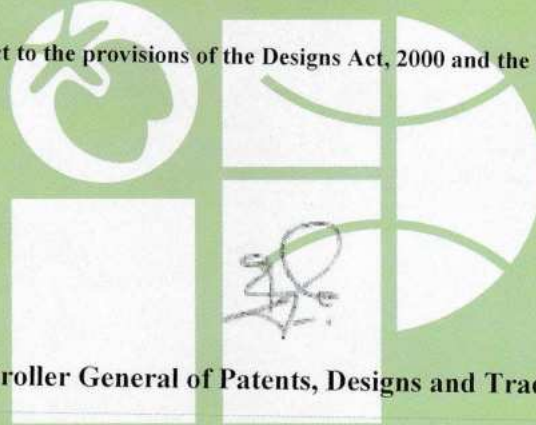

Controller General of Patents, Designs and Trade Marks

*The reciprocity date (if any) which has been allowed and the name of the country.

Copyright in the design will subsist for ten years from the date of Registration, and may under the terms of the Act and Rules, be extended for a further period of five years.

This Certificate is not for use in legal proceedings or for obtaining registration abroad

DHARTI SHAH,
VERITE ASSOCIATES, 105, SCARLET GATEWAY, NR.
SPIPA ACADEMY, CORPORATE ROAD,
PRAHALADNAGR, AHMEDABAD-380015, GUJARAT,
INDIA

Date of Issue 19/01/2022 13:50:38

(REPRESENTATION SHEETS)

NAME OF THE APPLICANT
NIHAR V. RAVAL
VEDKUMAR NARESHBHAI PATEL

NO. OF SHEETS - 3
SHEET NO. - 1

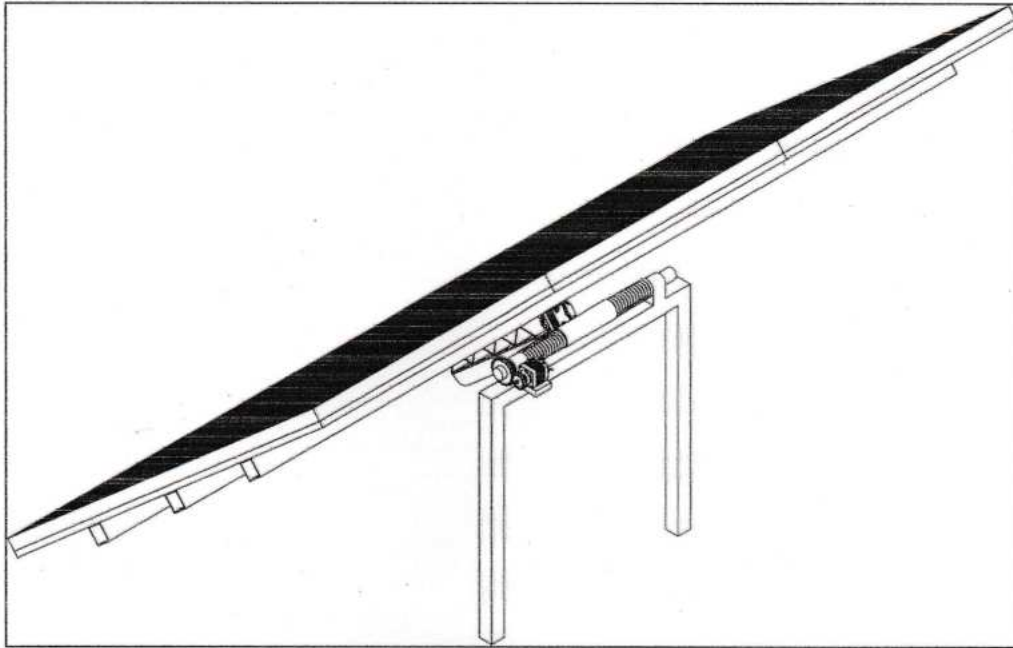

PERSPECTIVE VIEW

The novelty resides in the shape and configuration of the '**WALL MOUNTED ACTIVE SOLAR TRACKER**' as illustrated.

No claim is made by virtue of this registration in respect of any mechanical or other action of the mechanism whatever or in respect of any mode or principle of construction of the article.

No claim is made by virtue of the registration to any right to the exclusive use of the words, letters, numbers, colour, combination or Trade Marks as appearing in the representation.

353744-001

26 NOV 2021

Ms. DHARTI SHAH
(Authorized Agent of the Applicant)
(IN/PA- 2590)

(REPRESENTATION SHEETS)

NAME OF THE APPLICANT
NIHAR V. RAVAL
VEDKUMAR NARESHBHAI PATEL

NO. OF SHEETS - 3
SHEET NO. - 2

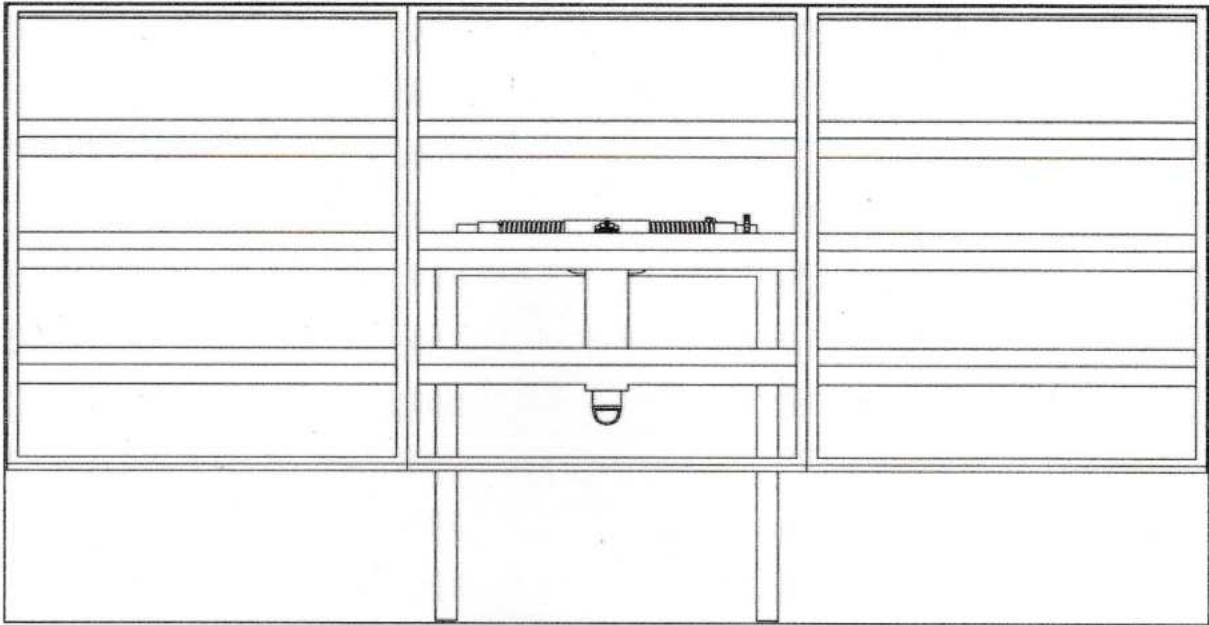

FRONT VIEW

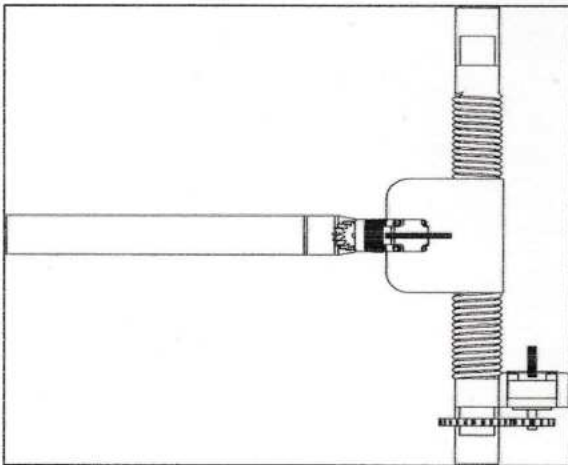

TOP VIEW

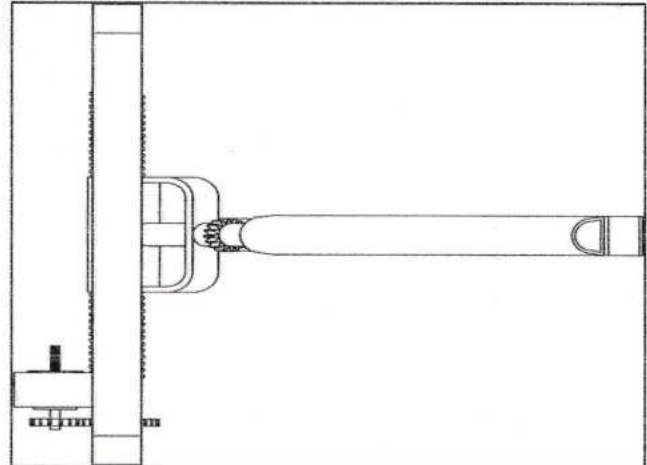

BOTTOM VIEW

The novelty resides in the shape and configuration of the 'WALL MOUNTED ACTIVE SOLAR TRACKER' as illustrated.

No claim is made by virtue of this registration in respect of any mechanical or other action of the mechanism whatever or in respect of any mode or principle of construction of the article.

No claim is made by virtue of the registration to any right to the exclusive use of the words, letters, numbers, colour, combination or Trade Marks as appearing in the representation.

353744-001
26 NOV 2021

Ms. DHARTI SHAH
(Authorized Agent of the Applicant)
(IN/PA- 2590)

(REPRESENTATION SHEETS)

NAME OF THE APPLICANT
NIHAR V. RAVAL
VEDKUMAR NARESHBHAI PATEL

NO. OF SHEETS - 3
SHEET NO. - 3

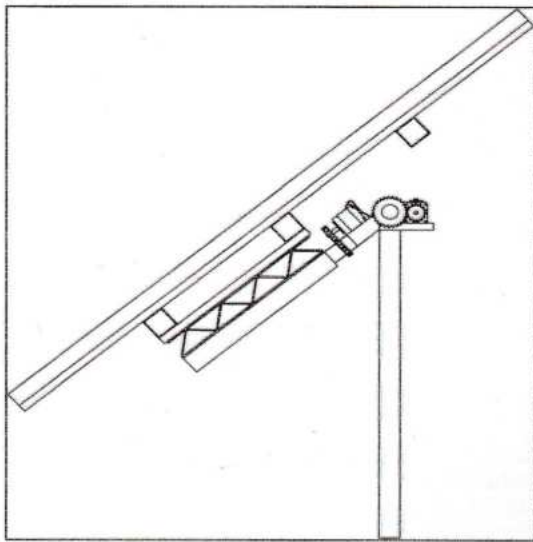

LEFT SIDE VIEW

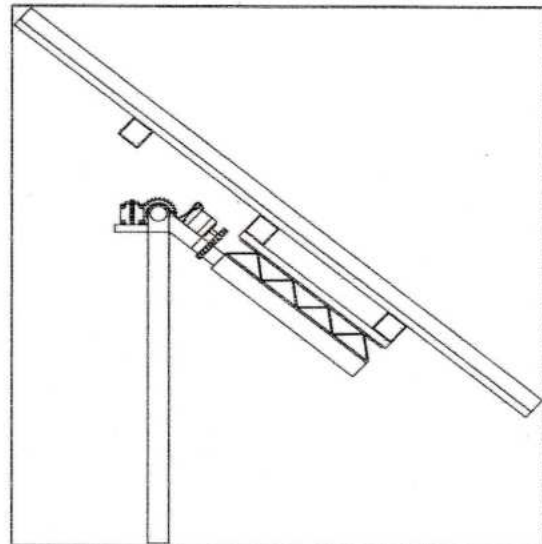

RIGHT SIDE VIEW

The novelty resides in the shape and configuration of the 'WALL MOUNTED ACTIVE SOLAR TRACKER' as illustrated.



No claim is made by virtue of this registration in respect of any mechanical or other action of the mechanism whatever or in respect of any mode or principle of construction of the article.

No claim is made by virtue of the registration to any right to the exclusive use of the words, letters, numbers, colour, combination or Trade Marks as appearing in the representation.

353744 -001

26 NOV 2021

Ms. DHARTI SHAH
(Authorized Agent of the Applicant)
(IN/PA- 2590)

DESIGN NUMBER	353733-001		
CLASS	12-16		
HONDA ACCESS CORP., 18-4, NOBIDOME 8-CHOME, NIIZA-SHI, SAITAMA, 352-8589 JAPAN.			
DATE OF REGISTRATION	26/11/2021		
TITLE	TRUNK SPOILER FOR AN AUTOMOBILE		
PRIORITY			
PRIORITY NUMBER	DATE	COUNTRY	
2021-011732	01/06/2021	JAPAN	
DESIGN NUMBER	353744-001		
CLASS	13-04		
1.NIHAR V. RAVAL, SILVER OAK UNIVERSITY CAMPUS, OPP. BHAGWAT VIDYAPITH, S.G ROAD, GOTA, AHMEDABAD – 382481, INDIA 2. VEDKUMAR NARESHBHAI PATEL, SILVER OAK UNIVERSITY CAMPUS, OPP. BHAGWAT VIDYAPITH, S.G ROAD, GOTA, AHMEDABAD – 382481, INDIA			
DATE OF REGISTRATION	26/11/2021		
TITLE	WALL MOUNTED ACTIVE SOLAR TRACKER		
PRIORITY NA			
DESIGN NUMBER	353760-001		
CLASS	03-01		
1.YOGIRAJ BRAHMBHATT, SILVER OAK UNIVERSITY CAMPUS, OPP. BHAGWAT VIDYAPITH, S.G ROAD, GOTA, AHMEDABAD – 382481, INDIA 2. SHACHI JOSHI, SILVER OAK UNIVERSITY CAMPUS, OPP. BHAGWAT VIDYAPITH, S.G ROAD, GOTA, AHMEDABAD – 382481, INDIA 3. HARDIKA MENGHANI, SILVER OAK UNIVERSITY CAMPUS, OPP. BHAGWAT VIDYAPITH, S.G ROAD, GOTA, AHMEDABAD – 382481, INDIA			
DATE OF REGISTRATION	26/11/2021		
TITLE	MOBILE KICKSTAND COVER WITH ATTACHED EJECTOR PIN		
PRIORITY NA			



सत्यमेव जयते

भारत सरकार
GOVERNMENT OF INDIA
पेटेंट कार्यालय
THE PATENT OFFICE

ORIGINAL

No. 104536

CERTIFICATE OF REGISTRATION OF DESIGN

Design No. 348962-001
Date 06/09/2021 17:02:25
Reciprocity Date*
Country

Certified that the design of which a copy is annexed hereto has been registered as of the number and date given above in class 12-16 in respect of the application of such design to FRONT KNUCKLE in the name of 1.MIT SHAH, SILVER OAK UNIVERSITY CAMPUS, OPP. BHAGWAT VIDYAPITH, S.G ROAD, GOTA, AHMEDABAD - 382421, INDIA, 2. RIPEN SHAH, SILVER OAK UNIVERSITY CAMPUS, OPP. BHAGWAT VIDYAPITH, S.G ROAD, GOTA, AHMEDABAD - 382421, INDIA.

in pursuance of and subject to the provisions of the Designs Act, 2000 and the Designs Rules, 2001.

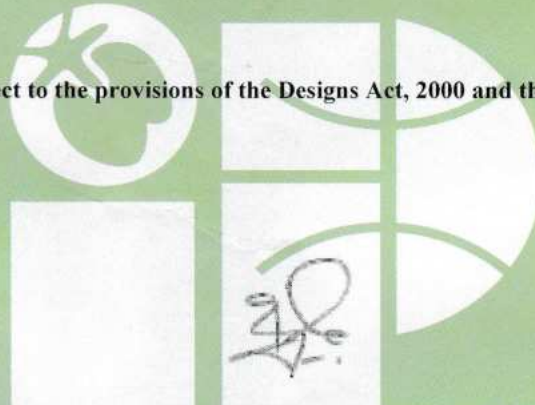

Controller General of Patents, Designs and Trade Marks

*The reciprocity date (if any) which has been allowed and the name of the country.

Copyright in the design will subsist for ten years from the date of Registration, and may under the terms of the Act and Rules, be extended for a further period of five years.

This Certificate is not for use in legal proceedings or for obtaining registration abroad

MS. DHARTI SHAH,
VERITE ASSOCIATES, 105, SCARLET GATEWAY,
NR.SPIPA ACADEMY, CORPORATE ROAD,
PRAHALADNAGR, AHMEDABAD-380015, GUJARAT,
INDIA

Date of Issue 10/11/2021 13:25:40

INTELLECTUAL
PROPERTY INDIA
PATENTS | DESIGNS | TRADE MARKS
GEOGRAPHICAL INDICATIONS

(REPRESENTATION SHEETS)

Name of the Applicant
Mit Shah
Ripen Shah

No. of Sheets - 3
Sheet No. - 1



PERSPECTIVE VIEW

The novelty resides in the shape and configuration of the 'FRONT KNUCKLE' as illustrated.

~~A Front Knuckle is used in all-terrain vehicle to control suspension and steering with lighter material to improve its performance.~~

No claim is made by virtue of this registration in respect of any mechanical or other action of the mechanism whatever or in respect of any mode or principle of construction of the article.

No claim is made by virtue of the registration to any right to the exclusive use of the words, letters, numbers, colour, combination or Trade Marks as appearing in the representation.

348962-001

06 SEP 2021

Ms. DHARTI SHAH
(Authorized Agent of the Applicant
(IN/PA- 2590)

(REPRESENTATION SHEETS)

Name of the Applicant
Mit Shah
Ripen Shah

No. of Sheets - 3
Sheet No. - 2

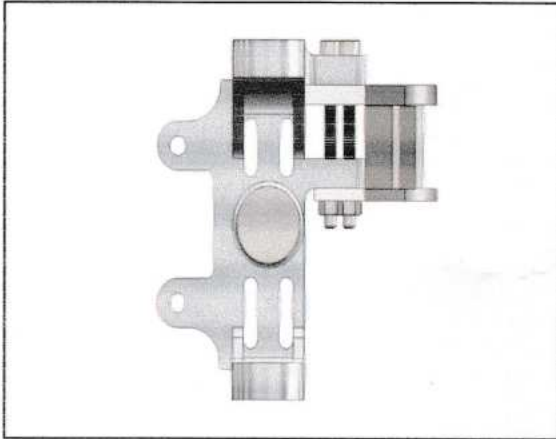

FRONT VIEW

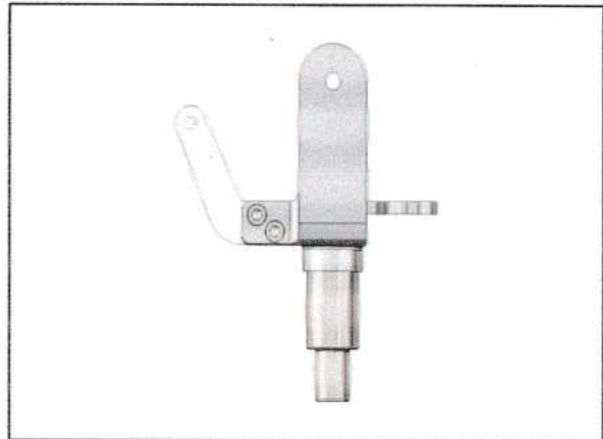

TOP VIEW

The novelty resides in the shape and configuration of the 'FRONT KNUCKLE' as illustrated.

~~A Front Knuckle is used in all-terrain vehicle to control suspension and steering with lighter material to improve its performance.~~

No claim is made by virtue of this registration in respect of any mechanical or other action of the mechanism whatever or in respect of any mode or principle of construction of the article.

No claim is made by virtue of the registration to any right to the exclusive use of the words, letters, numbers, colour, combination or Trade Marks as appearing in the representation.

348962-001
06 SEP 2021

MS. DHARTI SHAH
(Authorized Agent of the Applicant
(IN/PA- 2590)

(REPRESENTATION SHEETS)

Name of the Applicant

Mit Shah

Ripen Shah

No. of Sheets - 3

Sheet No. - 3

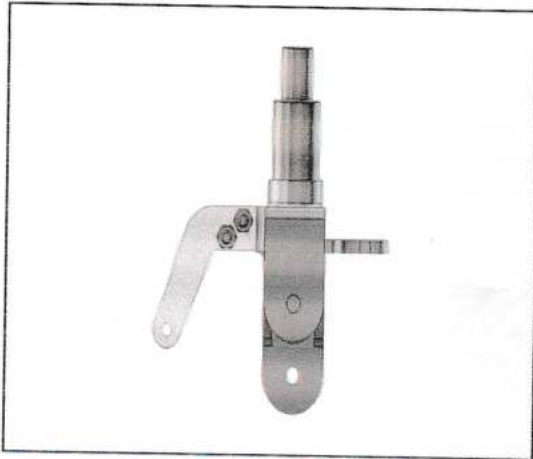

BOTTOM VIEW

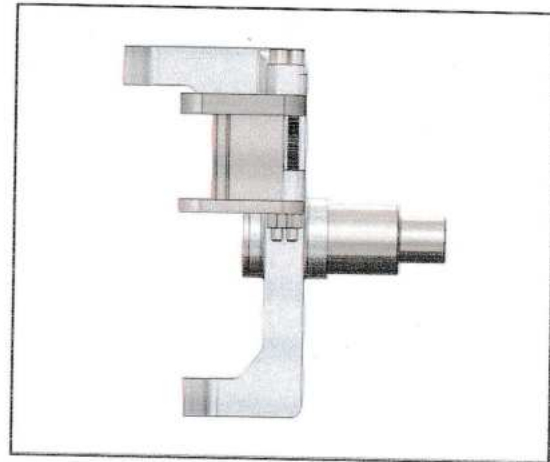

LEFT SIDE VIEW

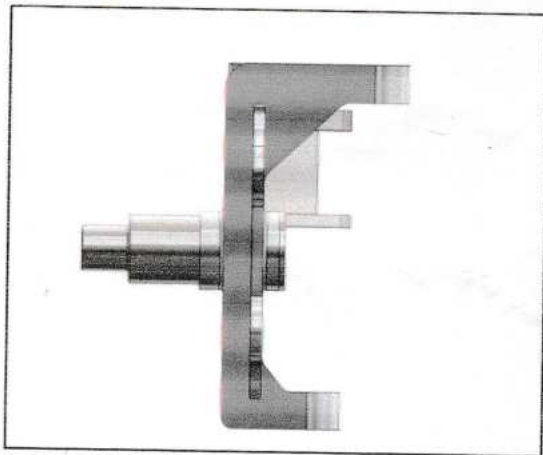

RIGHT SIDE VIEW

The novelty resides in the shape and configuration of the '**FRONT KNUCKLE**' as illustrated.



~~A Front Knuckle is used in all-terrain vehicle to control suspension and steering with lighter material to improve its performance.~~

No claim is made by virtue of this registration in respect of any mechanical or other action of the mechanism whatever or in respect of any mode or principle of construction of the article.

No claim is made by virtue of the registration to any right to the exclusive use of the words, letters, numbers, colour, combination or Trade Marks as appearing in the representation.

348962-001
06 SEP 2021

Ms. DHARTI SHAH
(Authorized Agent of the Applicant
(IN/PA- 2590)

DESIGN NUMBER	339855-001	
CLASS	02-02	
ITALIYA JEMISH SHANTIBHAI, MAIN BAZAR, NAVAPARA, NAGDHANIBA, DIS.- BHAVNAGAR-364050.		
DATE OF REGISTRATION	26/02/2021	
TITLE	GHAGHRA CHOLI WITH DUPATTA (SET)	
PRIORITY NA		
DESIGN NUMBER	348961-001	
CLASS	12-16	
1.BHAVDEEP RAMESHBHAI TRIVEDI, SILVER OAK UNIVERSITY CAMPUS, OPP. BHAGWAT VIDYAPITH, S.G ROAD, GOTA, AHMEDABAD - 382421 2. VIRAT DHOLAKIYA, SILVER OAK UNIVERSITY CAMPUS, OPP. BHAGWAT VIDYAPITH, S.G ROAD, GOTA, AHMEDABAD - 382421		
DATE OF REGISTRATION	06/09/2021	
TITLE	DRIVE AXLE	
PRIORITY NA		
DESIGN NUMBER	348962-001	
CLASS	12-16	
1.MIT SHAH, SILVER OAK UNIVERSITY CAMPUS, OPP. BHAGWAT VIDYAPITH, S.G ROAD, GOTA, AHMEDABAD - 382421, INDIA, 2. RIPEN SHAH, SILVER OAK UNIVERSITY CAMPUS, OPP. BHAGWAT VIDYAPITH, S.G ROAD, GOTA, AHMEDABAD - 382421, INDIA.		
DATE OF REGISTRATION	06/09/2021	
TITLE	FRONT KNUCKLE	
PRIORITY NA		



ORIGINAL

No. 105243

सत्यमेव जयते
भारत सरकार
GOVERNMENT OF INDIA
पेटेंट कार्यालय
THE PATENT OFFICE

CERTIFICATE OF REGISTRATION OF DESIGN

Design No. 348964-001
Date 06/09/2021 17:02:25
Reciprocity Date*
Country

Certified that the design of which a copy is annexed hereto has been registered as of the number and date given above in class 12-16 in respect of the application of such design to REAR KNUCKLE in the name of 1. ANVESH JHAVERI, SILVER OAK UNIVERSITY CAMPUS, OPP. BHAGWAT VIDYAPITH, S.G ROAD, GOTA, AHMEDABAD - 382421, INDIA 2. ISHAN THAKAR, SILVER OAK UNIVERSITY CAMPUS, OPP. BHAGWAT VIDYAPITH, S.G ROAD, GOTA, AHMEDABAD - 382421, INDIA

in pursuance of and subject to the provisions of the Designs Act, 2000 and the Designs Rules, 2001.

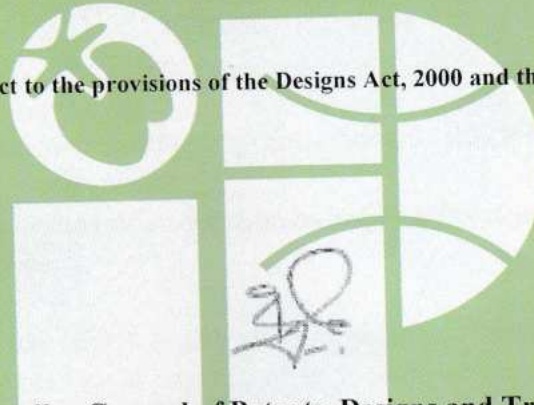

Controller General of Patents, Designs and Trade Marks

*The reciprocity date (if any) which has been allowed and the name of the country.

Copyright in the design will subsist for ten years from the date of Registration, and may under the terms of the Act and Rules, be extended for a further period of five years.

This Certificate is not for use in legal proceedings or for obtaining registration abroad

MS. DHARTI SHAH,
VERITE ASSOCIATES, 105, SCARLET GATEWAY,
NR. SPIPA ACADEMY, CORPORATE ROAD,
PRAHALADNAGR, AHMEDABAD-380015, GUJARAT,
INDIA

Date of Issue 25/11/2021 16:06:15

INTELLECTUAL
PROPERTY INDIA
PATENTS | DESIGNS | TRADE MARKS
GEOGRAPHICAL INDICATIONS

(REPRESENTATION SHEETS)

Name of the Applicant
Ishan Thakar
Anvesh Jhaveri

No. of Sheets - 3
Sheet No. - 1

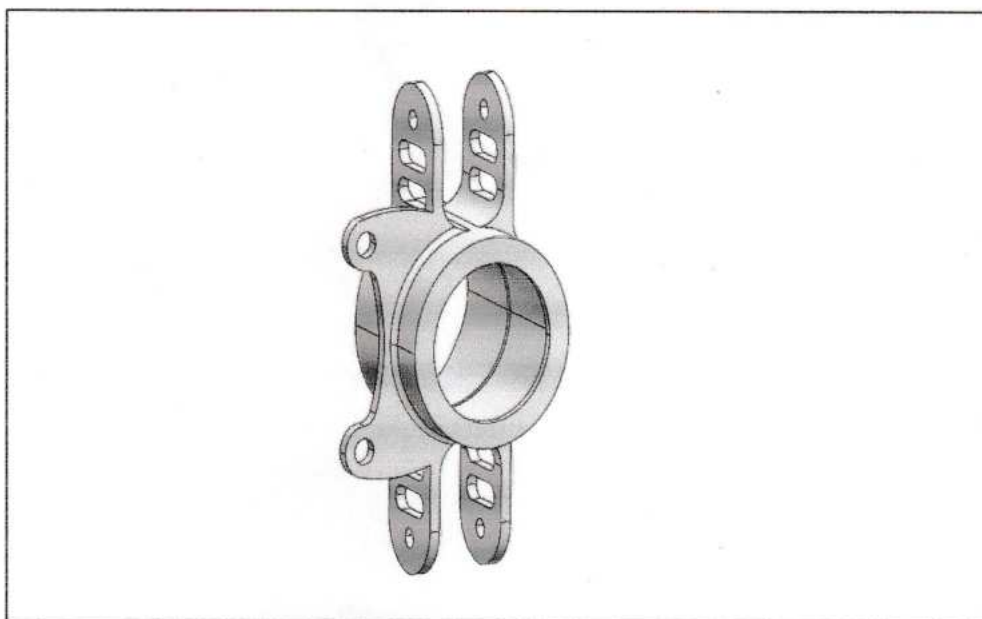

PERSPECTIVE VIEW

The novelty resides in the shape and configuration of the 'REAR KNUCKLE' as illustrated.

~~A Rear Knuckle is used in all terrain vehicle to control suspension and steering with lighter material to improve its performance.~~

No claim is made by virtue of this registration in respect of any mechanical or other action of the mechanism whatever or in respect of any mode or principle of construction of the article.

No claim is made by virtue of the registration to any right to the exclusive use of the words, letters, numbers, colour, combination or Trade Marks as appearing in the representation.

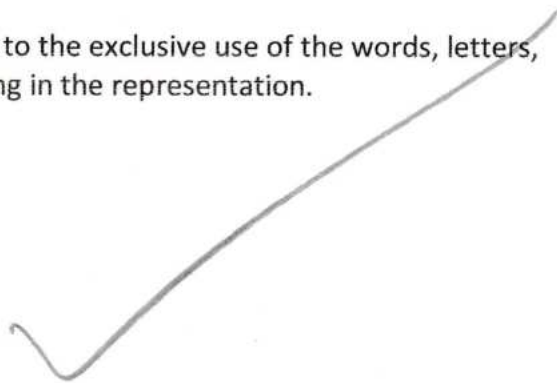

348964-001
06 SEP 2021

Ms. DHARTI SHAH
(Authorized Agent of the Applicant)
(IN/PA- 2590)

(REPRESENTATION SHEETS)

Name of the Applicant
Ishan Thakar
Anvesh Jhaveri

No. of Sheets – 3
Sheet No. - 2

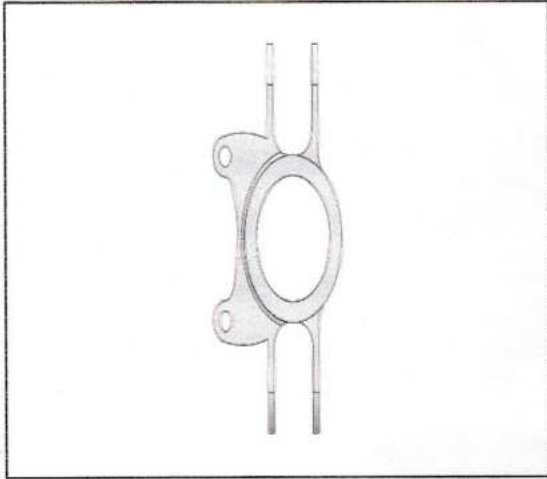

FRONT VIEW

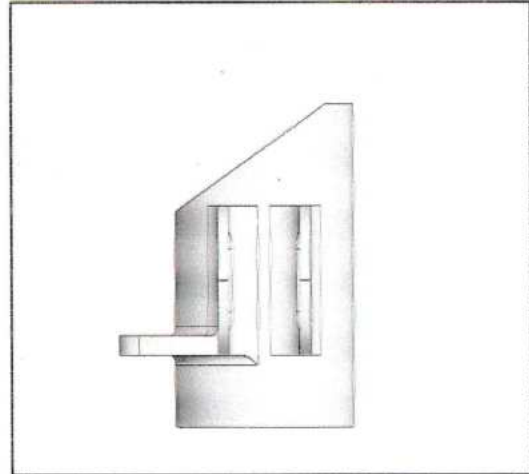

TOP VIEW

The novelty resides in the shape and configuration of the 'REAR KNUCKLE' as illustrated.

~~A Rear Knuckle is used in all-terrain vehicle to control suspension and steering with lighter material to improve its performance.~~

No claim is made by virtue of this registration in respect of any mechanical or other action of the mechanism whatever or in respect of any mode or principle of construction of the article.

No claim is made by virtue of the registration to any right to the exclusive use of the words, letters, numbers, colour, combination or Trade Marks as appearing in the representation.

348964-001
06 SEP 2021

Ms. DHARTI SHAH
(Authorized Agent of the Applicant)
(IN/PA- 2590)

(REPRESENTATION SHEETS)

Name of the Applicant
Ishan Thakar
Anvesh Jhaveri

No. of Sheets - 3
Sheet No. - 3

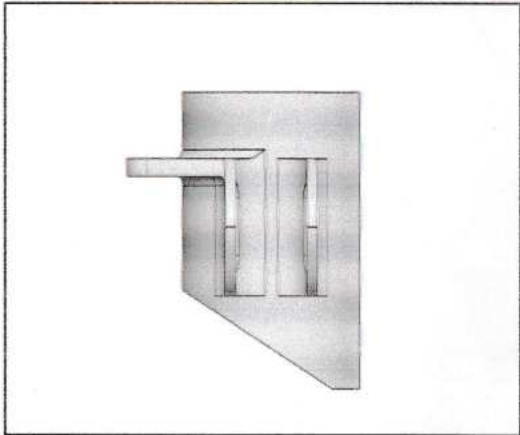

BOTTOM VIEW

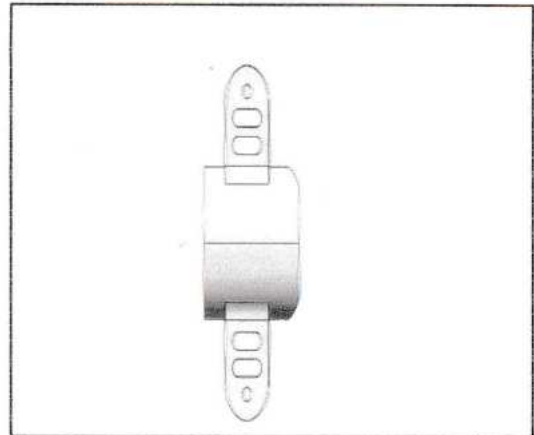

LEFT SIDE VIEW

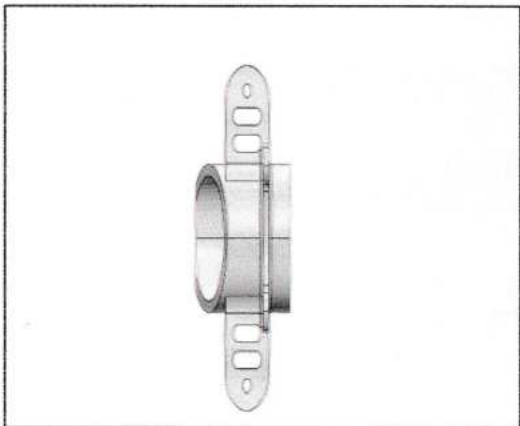

RIGHT SIDE VIEW

The novelty resides in the shape and configuration of the 'REAR KNUCKLE' as illustrated.

~~A Rear Knuckle is used in all terrain vehicle to control suspension and steering with lighter material to improve its performance.~~

No claim is made by virtue of this registration in respect of any mechanical or other action of the mechanism whatever or in respect of any mode or principle of construction of the article.

No claim is made by virtue of the registration to any right to the exclusive use of the words, letters, numbers, colour, combination or Trade Marks as appearing in the representation.

348964-001

06 SEP 2021

Ms. DHARTI SHAH
(Authorized Agent of the Applicant)
(IN/PA- 2590)

DESIGN NUMBER	336930-001	
CLASS	08-09	
JAYDIP D. BUSA, 717-SANSKAR HIGHTS, 150- FEET RING ROAD, MAVVDI CHOWKDI, RAJKOT- GUJARAT INDIA, TRADING AS DEEPAK MANUFACTURE		
DATE OF REGISTRATION	29/12/2020	
TITLE	SPIGOT	
PRIORITY NA		
DESIGN NUMBER	348964-001	
CLASS	12-16	
1.ANVESH JHAVERI, SILVER OAK UNIVERSITY CAMPUS, OPP. BHAGWAT VIDYAPITH, S.G ROAD, GOTA, AHMEDABAD - 382421, INDIA 2. ISHAN THAKAR, SILVER OAK UNIVERSITY CAMPUS, OPP. BHAGWAT VIDYAPITH, S.G ROAD, GOTA, AHMEDABAD - 382421, INDIA		
DATE OF REGISTRATION	06/09/2021	
TITLE	REAR KNUCKLE	
PRIORITY NA		
DESIGN NUMBER	348985-001	
CLASS	31-00	
1.DR. PRASANT KUMAR PATTNAIK, PROFESSOR, SCHOOL OF COMPUTER ENGINEERING, KIIT DU, BHUBANESWAR 751024, ODISHA, INDIA. 2. AVANEESH OM, B.TECH (IT) STUDENT, SCHOOL OF COMPUTER ENGINEERING, KIIT DU, BHUBANESWAR-751024, ODISHA, INDIA 3. KRITTIKA GHOSH, B.TECH (IT) STUDENT, SCHOOL OF COMPUTER ENGINEERING, KIIT DU, BHUBANESWAR-751024, ODISHA, INDIA 4. DR. ALEENA SWETAPADMA, ASSISTANT PROFESSOR, SCHOOL OF COMPUTER ENGINEERING, KIIT DU, BHUBANESWAR-751024, ODISHA, INDIA		
DATE OF REGISTRATION	06/09/2021	
TITLE	AUTOMATED TEA MAKING MACHINE	
PRIORITY NA		



ORIGINAL

No. 104519

भारत सरकार
GOVERNMENT OF INDIA
पेटेंट कार्यालय
THE PATENT OFFICE

CERTIFICATE OF REGISTRATION OF DESIGN

Design No. 348968-001
Date 06/09/2021 17:02:25
Reciprocity Date*
Country

Certified that the design of which a copy is annexed hereto has been registered as of the number and date given above in class 12-16 in respect of the application of such design to REAR WHEEL HUB in the name of 1.ASIFALI SHEKH, SILVER OAK UNIVERSITY CAMPUS, OPP. BHAGWAT VIDYAPITH, S.G ROAD, GOTA, AHMEDABAD - 382421, INDIA 2. NEJAL PATEL, SILVER OAK UNIVERSITY CAMPUS, OPP. BHAGWAT VIDYAPITH, S.G ROAD, GOTA, AHMEDABAD - 382421, INDIA.

in pursuance of and subject to the provisions of the Designs Act, 2000 and the Designs Rules, 2001.

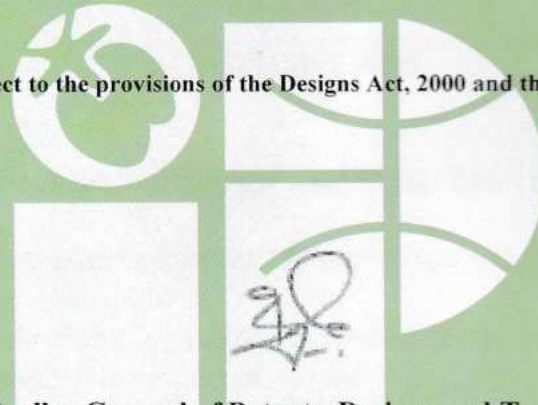

Controller General of Patents, Designs and Trade Marks

*The reciprocity date (if any) which has been allowed and the name of the country.

Copyright in the design will subsist for ten years from the date of Registration, and may under the terms of the Act and Rules, be extended for a further period of five years.

This Certificate is not for use in legal proceedings or for obtaining registration abroad

MS. DHARTI SHAH,
VERITE ASSOCIATES, 105, SCARLET GATEWAY, NR.
SPIPA ACADEMY, CORPORATE ROAD,
PRAHALADNAGR, AHMEDABAD-380015, GUJARAT,
INDIA

Date of Issue 10/11/2021 13:08:11

INTELLECTUAL
PROPERTY INDIA
PATENTS | DESIGNS | TRADE MARKS
GEOGRAPHICAL INDICATIONS

(REPRESENTATION SHEETS)

Name of the Applicant
Asifali Shekh
Nejal Patel

No. of Sheets - 3
Sheet No. - 1

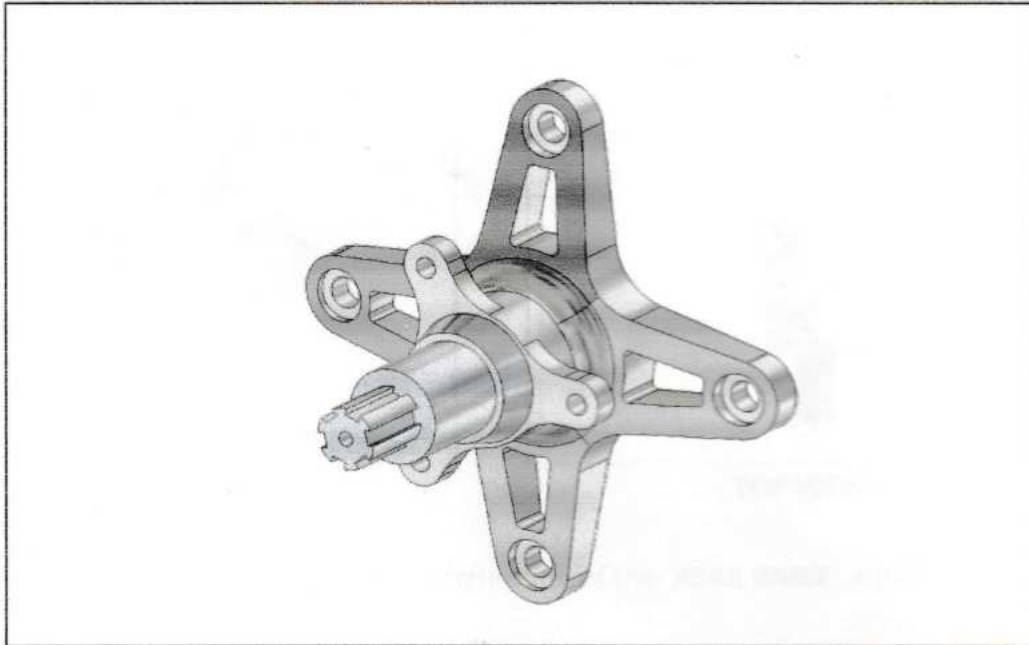

PERSPECTIVE VIEW

The novelty resides in the shape and configuration of the 'REAR WHEEL HUB' as illustrated.

~~A Rear Wheel Hub is used for all-terrain vehicle with lighter material to improve its performance.~~

No claim is made by virtue of this registration in respect of any mechanical or other action of the mechanism whatever or in respect of any mode or principle of construction of the article.

No claim is made by virtue of the registration to any right to the exclusive use of the words, letters, numbers, colour, combination or Trade Marks as appearing in the representation.

Ms. DHARTI SHAH
(Authorized Agent of the Applicant)
(IN/PA- 2590)

348968-001

06 SEP 2021

(REPRESENTATION SHEETS)

Name of the Applicant
Asifali Shekh
Nejal Patel

No. of Sheets – 3
Sheet No. -2



FRONT VIEW

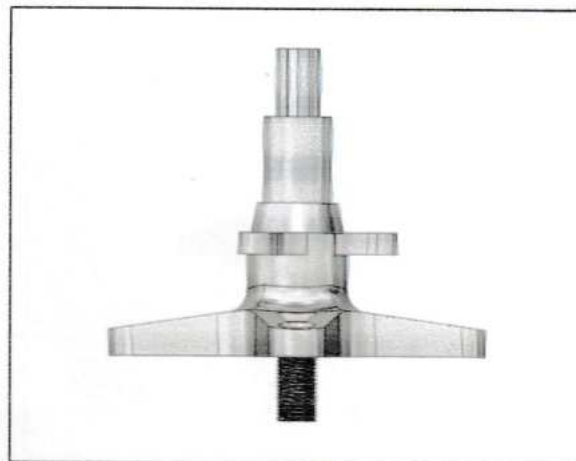

TOP VIEW

The novelty resides in the shape and configuration of the 'REAR WHEEL HUB' as illustrated.

~~A Rear Wheel Hub is used for all-terrain vehicle with lighter material to improve its performance,~~

No claim is made by virtue of this registration in respect of any mechanical or other action of the mechanism whatever or in respect of any mode or principle of construction of the article.

No claim is made by virtue of the registration to any right to the exclusive use of the words, letters, numbers, colour, combination or Trade Marks as appearing in the representation.

Ms. DHARTI SHAH
(Authorized Agent of the Applicant)
(IN/PA- 2590)

348968-001

(Authorized Agent of the Applicant)

(IN/PA- 2590)

06 SEP 2021

(REPRESENTATION SHEETS)

Name of the Applicant
Asifali Shekh
Nejal Patel

No. of Sheets - 3
Sheet No. -3

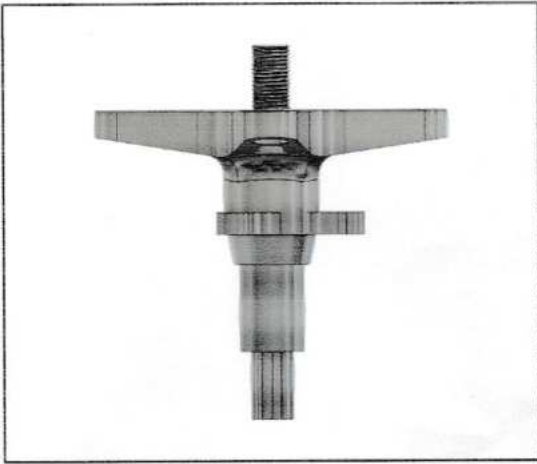

BOTTOM VIEW

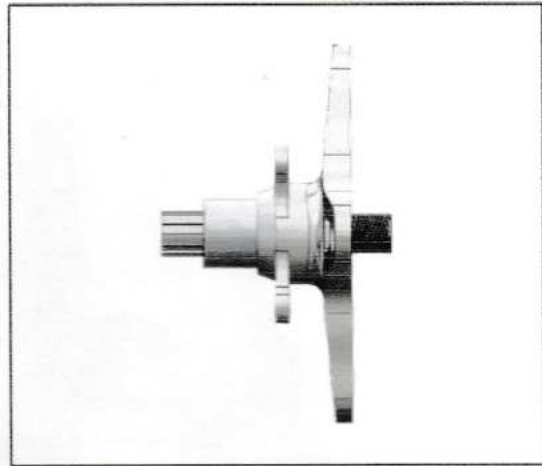

LEFT SIDE VIEW

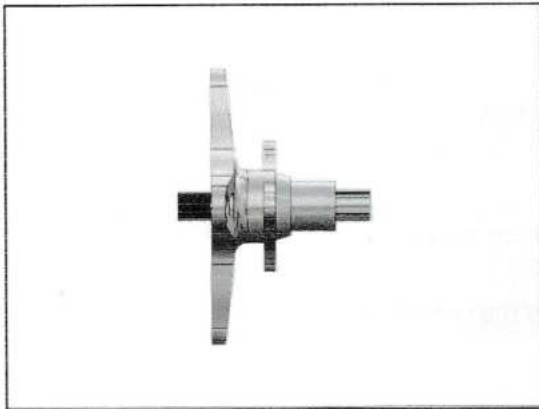

RIGHT SIDE VIEW

The novelty resides in the shape and configuration of the 'REAR WHEEL HUB' as illustrated.

~~A Rear Wheel Hub is used for all-terrain vehicle with lighter material to improve its performance.~~



No claim is made by virtue of this registration in respect of any mechanical or other action of the mechanism whatever or in respect of any mode or principle of construction of the article.

No claim is made by virtue of the registration to any right to the exclusive use of the words, letters, numbers, colour, combination or Trade Marks as appearing in the representation.

348968-001

06 SEP 2021

Ms. DHARTI SHAH
(Authorized Agent of the Applicant)
(IN/PA- 2590)

DESIGN NUMBER	348968-001	
CLASS	12-16	
1.ASIFALI SHEKH, SILVER OAK UNIVERSITY CAMPUS, OPP. BHAGWAT VIDYAPITH, S.G ROAD, GOTA, AHMEDABAD - 382421, INDIA 2. NEJAL PATEL, SILVER OAK UNIVERSITY CAMPUS, OPP. BHAGWAT VIDYAPITH, S.G ROAD, GOTA, AHMEDABAD - 382421, INDIA.		
DATE OF REGISTRATION	06/09/2021	
TITLE	REAR WHEEL HUB	
PRIORITY NA		
DESIGN NUMBER	348971-001	
CLASS	15-09	
SHEKHAR KRISHNA TIRANDAS, 31/3, DAYAM MANZIL, 13TH KAMATHI PURA, S. P. ROAD, NAGPADA, MUMBAI – 400008		
DATE OF REGISTRATION	06/09/2021	
TITLE	WELDING MACHINE	
PRIORITY NA		
DESIGN NUMBER	348990-001	
CLASS	06-06	
SHOBHIT INSTITUTE OF ENGINEERING AND TECHNOLOGY (DEEMED TO-BE UNIVERSITY), NH-58, DULHERA MARG, MODIPURAM, MEERUT-250110, UTTAR PRADESH, INDIA.		
DATE OF REGISTRATION	06/09/2021	
TITLE	MUSIC NOTATION HOLDING STAND	
PRIORITY NA		



सत्यमेव जयते

भारत सरकार
GOVERNMENT OF INDIA
पेटेंट कार्यालय
THE PATENT OFFICE

ORIGINAL

No. 104878

CERTIFICATE OF REGISTRATION OF DESIGN

Design No. 348969-001
Date 06/09/2021 17:02:25
Reciprocity Date*
Country

Certified that the design of which a copy is annexed hereto has been registered as of the number and date given above in class 12-16 in respect of the application of such design to ROLL CAGE STRUCTURE in the name of 1.VIRAT DHOLAKIYA, SILVER OAK UNIVERSITY CAMPUS, OPP. BHAGWAT VIDYAPITH, S.G ROAD, GOTA, AHMEDABAD - 382421 2. RIPEN SHAH, SILVER OAK UNIVERSITY CAMPUS, OPP. BHAGWAT VIDYAPITH, S.G ROAD, GOTA, AHMEDABAD - 382421

in pursuance of and subject to the provisions of the Designs Act, 2000 and the Designs Rules, 2001.

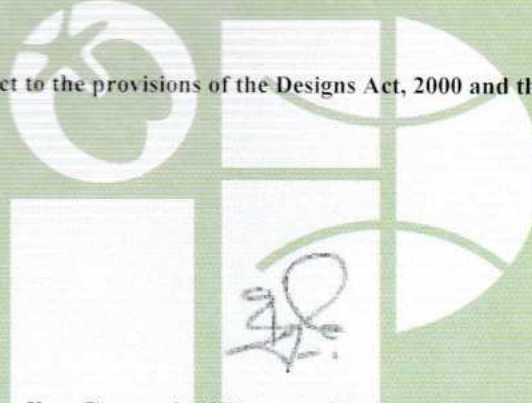

Controller General of Patents, Designs and Trade Marks

*The reciprocity date (if any) which has been allowed and the name of the country.

Copyright in the design will subsist for ten years from the date of Registration, and may under the terms of the Act and Rules, be extended for a further period of five years.

This Certificate is not for use in legal proceedings or for obtaining registration abroad

MS. DHARTI SHAH,
VERITE ASSOCIATES, 105, SCARLET GATEWAY, NR.
SPIPA ACADEMY, CORPORATE ROAD,
PRAHALADNAGR, AHMEDABAD-380015, GUJARAT,
INDIA

Date of Issue 16/11/2021 15:56:59

INTELLECTUAL
PROPERTY INDIA
PATENTS | DESIGNS | TRADE MARKS
GEOGRAPHICAL INDICATIONS

(REPRESENTATION SHEETS)

Name of the Applicant
Virat Dholakiya
Ripen Shah

No. of Sheets - 3
Sheet No. - 1

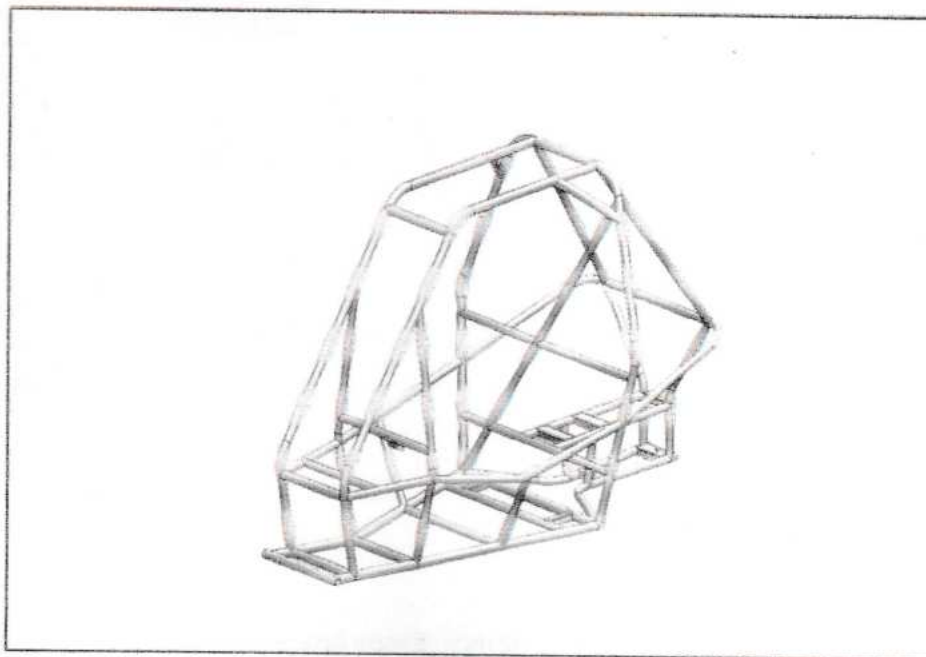

PERSPECTIVE VIEW

The novelty resides in the shape and configuration of the 'ROLLCAGE STRUCTURE' as illustrated.

A Rollcage Structure is specially designed chassis for all-terrain vehicle to make the structure safe and light in weight.

No claim is made by virtue of this registration in respect of any mechanical or other action of the mechanism whatever or in respect of any mode or principle of construction of the article.

No claim is made by virtue of the registration to any right to the exclusive use of the words, letters, numbers, colour, combination or Trade Marks as appearing in the representation.

348969-001
06 SEP 2021

Ms. DHARTI SHAH
(Authorized Agent of the Applicant)
(IN/PA- 2590)

(REPRESENTATION SHEETS)

Name of the Applicant
Virat Dholakiya
Ripen Shah

No. of Sheets - 3
Sheet No. - 2

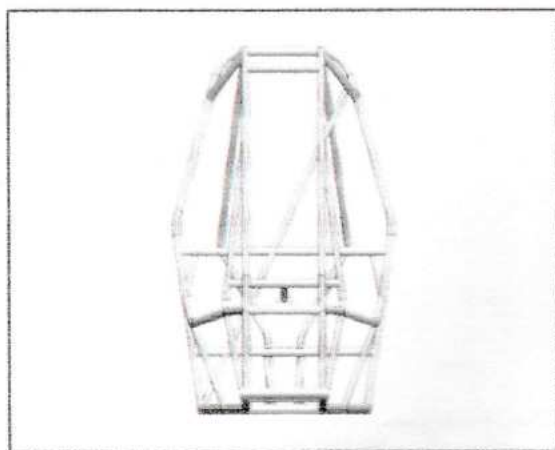

FRONT VIEW

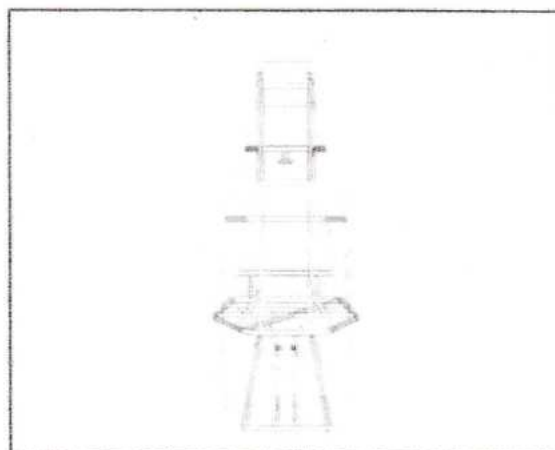

TOP VIEW

The novelty resides in the shape and configuration of the 'ROLLCAGE STRUCTURE' as illustrated.

A Rollcage Structure is specially designed chassis for all-terrain vehicle to make the structure safe and light in weight.

No claim is made by virtue of this registration in respect of any mechanical or other action of the mechanism whatever or in respect of any mode or principle of construction of the article.

No claim is made by virtue of the registration to any right to the exclusive use of the words, letters, numbers, colour, combination or Trade Marks as appearing in the representation.

348969-001

06 SEP 2021

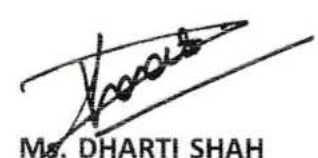
Ms. DHARTI SHAH
(Authorized Agent of the Applicant)
(IN/PA- 2590)

(REPRESENTATION SHEETS)

Name of the Applicant
Virat Dholakiya
Ripen Shah

No. of Sheets - 3
Sheet No. - 3

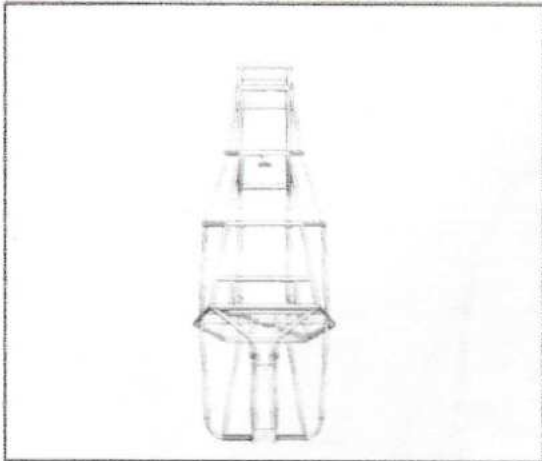

BOTTOM VIEW

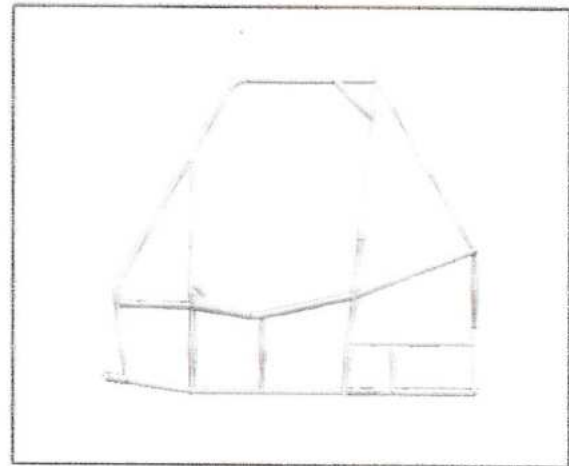

LEFT SIDE VIEW

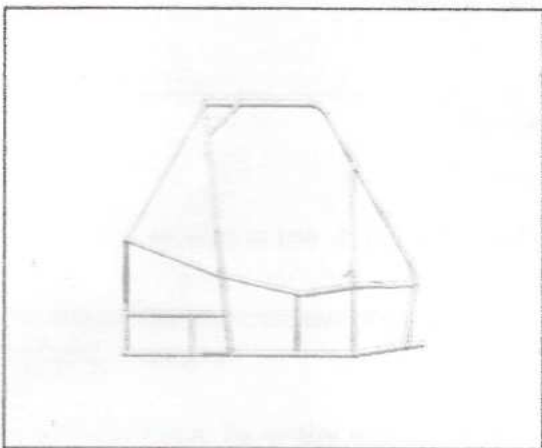

RIGHT SIDE VIEW

The novelty resides in the shape and configuration of the 'ROLLCAGE STRUCTURE' as illustrated.

A Rollcage Structure is specially designed chassis for all-terrain vehicle to make the structure safe and light in weight.



No claim is made by virtue of this registration in respect of any mechanical or other action of the mechanism whatever or in respect of any mode or principle of construction of the article.

No claim is made by virtue of the registration to any right to the exclusive use of the words, letters, numbers, colour, combination or Trade Marks as appearing in the representation.

348969 - 001

06 SEP 2021

Ms. DHARTI SHAH
(Authorized Agent of the Applicant)
(IN/PA- 2590)

DESIGN NUMBER	336906-001	
CLASS	08-06	
JAY SHREE KRUSHNA TRADING CO., 408, GIDC MANJUSAR (SAVLI), NEAR BOMBARDIAR CIRCLE, DIST. VADODARA - 391775, GUJARAT – INDIA, WHOSE PARTNERS ARE MANAL A. PARIKH AND SONAL A. PARIKH		
DATE OF REGISTRATION	28/12/2020	
TITLE	KNOB	
PRIORITY NA		
DESIGN NUMBER	348969-001	
CLASS	12-16	
1.VIRAT DHOLAKIYA, SILVER OAK UNIVERSITY CAMPUS, OPP. BHAGWAT VIDYAPITH, S.G ROAD, GOTA, AHMEDABAD - 382421 2. RIPEN SHAH, SILVER OAK UNIVERSITY CAMPUS, OPP. BHAGWAT VIDYAPITH, S.G ROAD, GOTA, AHMEDABAD - 382421		
DATE OF REGISTRATION	06/09/2021	
TITLE	ROLLCAGE STRUCTURE	
PRIORITY NA		
DESIGN NUMBER	349065-005	
CLASS	02-02	
RAJESHKUMAR POPATBHAI DHAMELIYA, 8TH FLOOR, SHOP NO. 805, ADATIYA AAWAS, OLD BOMBAY MARKET, UMARWADA, SURAT-395010, INDIA		
DATE OF REGISTRATION	07/09/2021	
TITLE	SAREE AND BLOUSE (SET)	
PRIORITY NA		



ORIGINAL

No. 103761

भारत सरकार
GOVERNMENT OF INDIA
पेटेंट कार्यालय
THE PATENT OFFICE

CERTIFICATE OF REGISTRATION OF DESIGN

Design No. 348966-001
Date 06/09/2021 17:02:25
Reciprocity Date*
Country

Certified that the design of which a copy is annexed hereto has been registered as of the number and date given above in class 12-16 in respect of the application of such design to BRAKE DISC in the name of 1.PRATIK GUPTA, SILVER OAK UNIVERSITY CAMPUS, OPP. BHAGWAT VIDYAPITH, S.G ROAD, GOTA, AHMEDABAD - 382421, INDIA 2. ISHAN THAKAR, SILVER OAK UNIVERSITY CAMPUS, OPP. BHAGWAT VIDYAPITH, S.G ROAD, GOTA, AHMEDABAD - 382421, INDIA

in pursuance of and subject to the provisions of the Designs Act, 2000 and the Designs Rules, 2001.

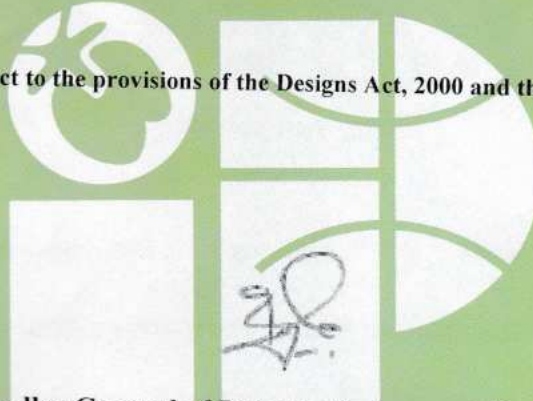

Controller General of Patents, Designs and Trade Marks

*The reciprocity date (if any) which has been allowed and the name of the country.

Copyright in the design will subsist for ten years from the date of Registration, and may under the terms of the Act and Rules, be extended for a further period of five years.

This Certificate is not for use in legal proceedings or for obtaining registration abroad

MR. DHARTI SHAH,
VERITE ASSOCIATES, 105, SCARLET GATEWAY,
NR.SPIPA ACADEMY, CORPORATE ROAD,
PRAHALADNAGR, AHMEDABAD-380015, GUJARAT,
INDIA

Date of Issue 21/10/2021 16:57:47

(REPRESENTATION SHEETS)

Name of the Applicant
Pratik Gupta
Ishan Thakar

No. of Sheets - 3
Sheet No. - 1

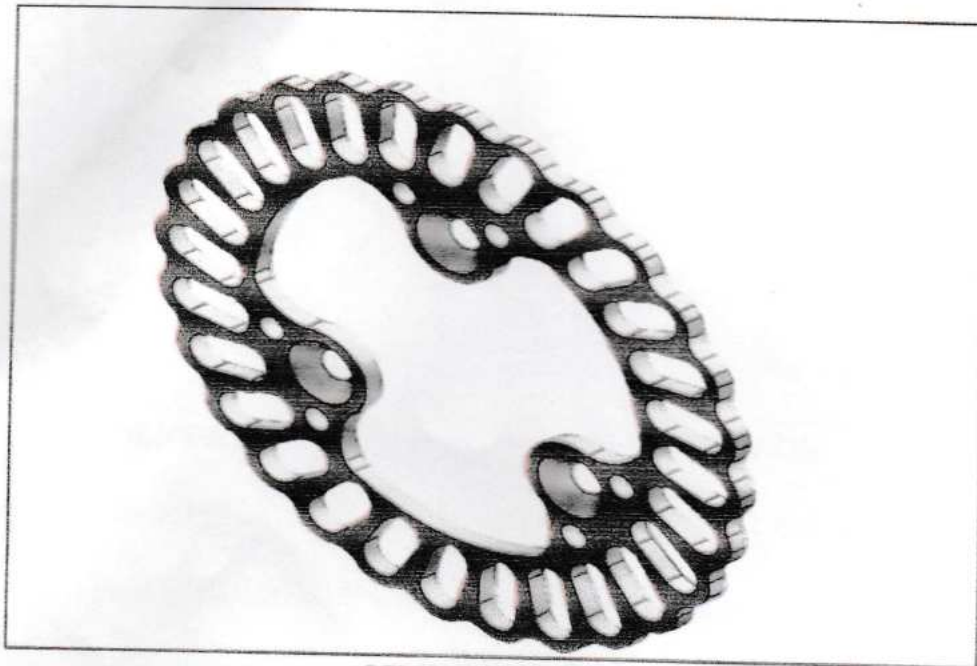

PERSPECTIVE VIEW

The novelty resides in the shape and configuration of the 'BRAKE DISC' as illustrated.

A Brake Disc is used in all-terrain vehicle to improve its braking performance.

No claim is made by virtue of this registration in respect of any mechanical or other action of the mechanism whatever or in respect of any mode or principle of construction of the article.

No claim is made by virtue of the registration to any right to the exclusive use of the words, letters, numbers, colour, combination or Trade Marks as appearing in the representation.

348966-001

06 SEP 2021

Ms. DHARTI SHAH
(Authorized Agent of the Applicant)
(IN/PA- 2590)

(REPRESENTATION SHEETS)

Name of the Applicant
Pratik Gupta
Ishan Thakar

No. of Sheets – 3
Sheet No. - 2



FRONT VIEW

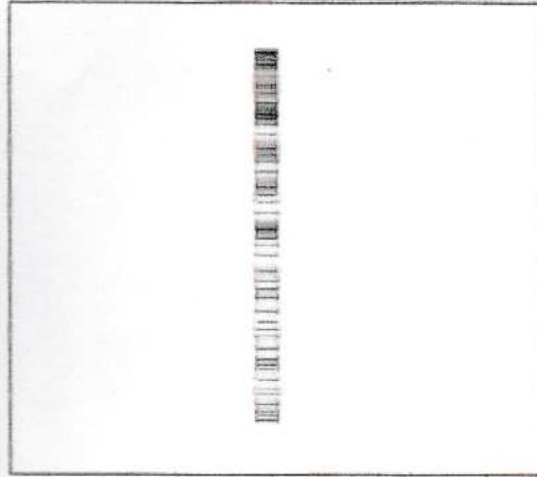

TOP VIEW

The novelty resides in the shape and configuration of the 'BRAKE DISC' as illustrated.

A Brake Disc is used in all-terrain vehicle to improve its braking performance.

No claim is made by virtue of this registration in respect of any mechanical or other action of the mechanism whatever or in respect of any mode or principle of construction of the article.

No claim is made by virtue of the registration to any right to the exclusive use of the words, letters, numbers, colour, combination or Trade Marks as appearing in the representation.

348966 -001

06 SEP 2021

Ms. DHARTI SHAH
(Authorized Agent of the Applicant)
(IN/PA- 2590)

(REPRESENTATION SHEETS)

Name of the Applicant
Pratik Gupta
Ishan Thakar

No. of Sheets - 3
Sheet No. - 3

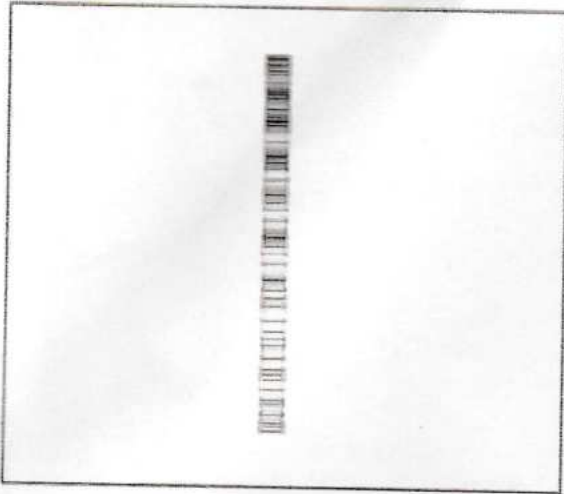

BOTTOM VIEW

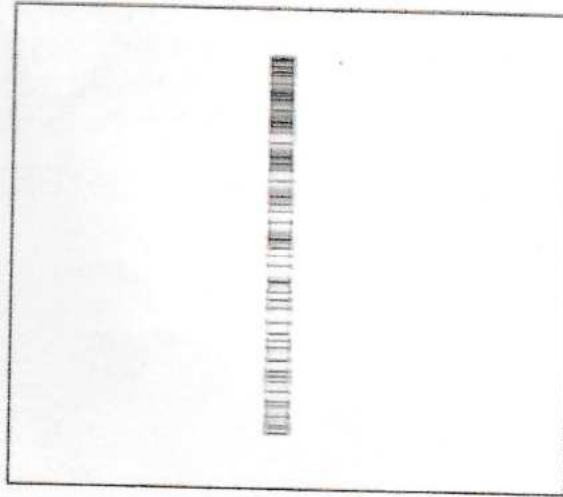

LEFT SIDE VIEW

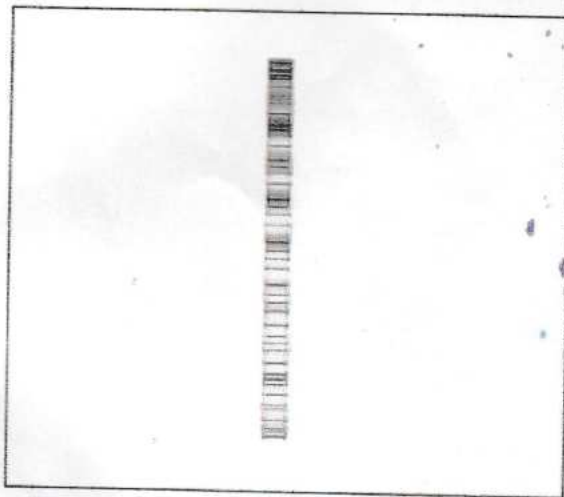

RIGHT SIDE VIEW

The novelty resides in the shape and configuration of the 'BRAKE DISC' as illustrated.

A Brake Disc is used in all-terrain vehicle to improve its braking performance.

No claim is made by virtue of this registration in respect of any mechanical or other action of the mechanism whatever or in respect of any mode or principle of construction of the article.

No claim is made by virtue of the registration to any right to the exclusive use of the words, letters, numbers, colour, combination or Trade Marks as appearing in the representation.

348966-001

06 SEP 2021

Ms. DHARTI SHAH
(Authorized Agent of the Applicant)
(IN/PA- 2590)

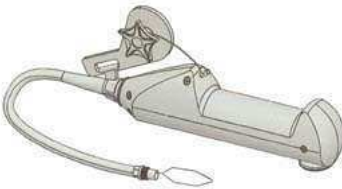
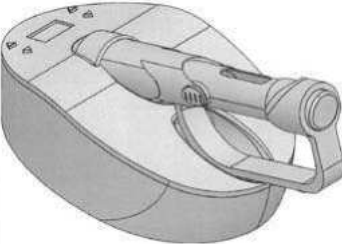
DESIGN NUMBER	348966-001	
CLASS	12-16	
1.PRATIK GUPTA, SILVER OAK UNIVERSITY CAMPUS, OPP. BHAGWAT VIDYAPITH, S.G ROAD, GOTA, AHMEDABAD - 382421, INDIA 2. ISHAN THAKAR, SILVER OAK UNIVERSITY CAMPUS, OPP. BHAGWAT VIDYAPITH, S.G ROAD, GOTA, AHMEDABAD - 382421, INDIA		
DATE OF REGISTRATION	06/09/2021	
TITLE	BRAKE DISC	
PRIORITY NA		
DESIGN NUMBER	348992-001	
CLASS	24-01	
SHOBHIT INSTITUTE OF ENGINEERING AND TECHNOLOGY (DEEMED TO-BE UNIVERSITY), NH-58, DULHERA MARG, MODIPURAM, MEERUT-250110, UTTAR PRADESH, INDIA.		
DATE OF REGISTRATION	06/09/2021	
TITLE	HEMORRHOID TREATMENT EQUIPMENT	
PRIORITY NA		
DESIGN NUMBER	348994-001	
CLASS	24-01	
SHOBHIT INSTITUTE OF ENGINEERING AND TECHNOLOGY (DEEMED TO-BE UNIVERSITY), NH-58, DULHERA MARG, MODIPURAM, MEERUT-250110, UTTAR PRADESH, INDIA.		
DATE OF REGISTRATION	06/09/2021	
TITLE	INJECTION HOLDING APPARATUS	
PRIORITY NA		



ORIGINAL

No. 104198

भारत सरकार
GOVERNMENT OF INDIA
पेटेंट कार्यालय
THE PATENT OFFICE

CERTIFICATE OF REGISTRATION OF DESIGN

Design No. 349843-001
Date 20/09/2021 20:16:25
Reciprocity Date*
Country

Certified that the design of which a copy is annexed hereto has been registered as of the number and date given above in class 12-16 in respect of the application of such design to FRONT KNUCKLE in the name of L.NEJAL PATEL, SILVER OAK UNIVERSITY CAMPUS, OPP. BHAGWAT VIDYAPITH, S.G ROAD, GOTA, AHMEDABAD - 382421 2. MARUT PATEL, SILVER OAK UNIVERSITY CAMPUS, OPP. BHAGWAT VIDYAPITH, S.G ROAD, GOTA, AHMEDABAD - 382421

in pursuance of and subject to the provisions of the Designs Act, 2000 and the Designs Rules, 2001.

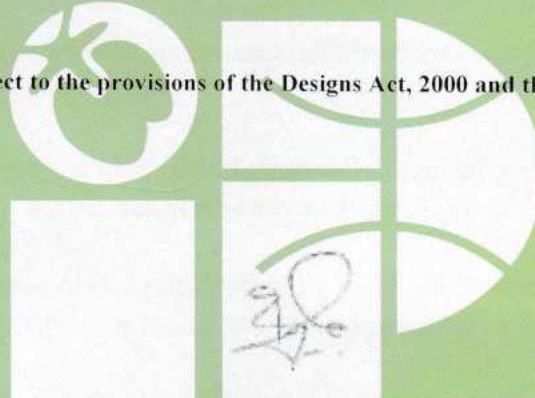

Controller General of Patents, Designs and Trade Marks

*The reciprocity date (if any) which has been allowed and the name of the country.

Copyright in the design will subsist for ten years from the date of Registration, and may under the terms of the Act and Rules, be extended for a further period of five years.

This Certificate is not for use in legal proceedings or for obtaining registration abroad

DR. DHARTI SHAH,
VERITE ASSOCIATES, 105, SCARLET GATEWAY, NR.
SPIPA ACADEMY, CORPORATE ROAD,
PRAHALADNAGR, AHMEDABAD-380015, GUJARAT,
INDIA

INTELLECTUAL
PROPERTY INDIA
PATENTS | DESIGNS | TRADE MARKS
GEOGRAPHICAL INDICATIONS

Date of Issue 01/11/2021 15:37:17

(REPRESENTATION SHEETS)

NAME OF THE APPLICANT
NEJAL PATEL
MARUT PATEL

NO. OF SHEETS - 3
SHEET NO. - 1

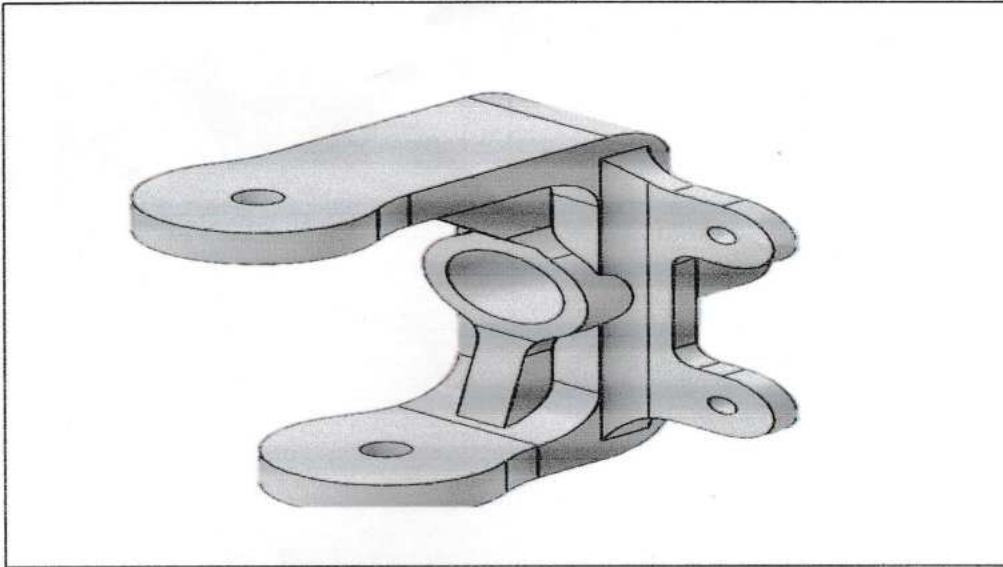

PERSPECTIVE VIEW

The novelty resides in the shape and configuration of the 'FRONT KNUCKLE' as illustrated.

~~A Front Knuckle is used in all terrain vehicle to control suspension and steering with lighter material to improve its performance.~~

No claim is made by virtue of this registration in respect of any mechanical or other action of the mechanism whatever or in respect of any mode or principle of construction of the article.

No claim is made by virtue of the registration to any right to the exclusive use of the words, letters, numbers, colour, combination or Trade Marks as appearing in the representation.

349843-001

20 SEP 2021

MS. DHARTI SHAH
(Authorized Agent of the Applicant)
(IN/PA- 2590)

(REPRESENTATION SHEETS)

NAME OF THE APPLICANT
NEJAL PATEL
MARUT PATEL

NO. OF SHEETS - 3
SHEET NO. - 2

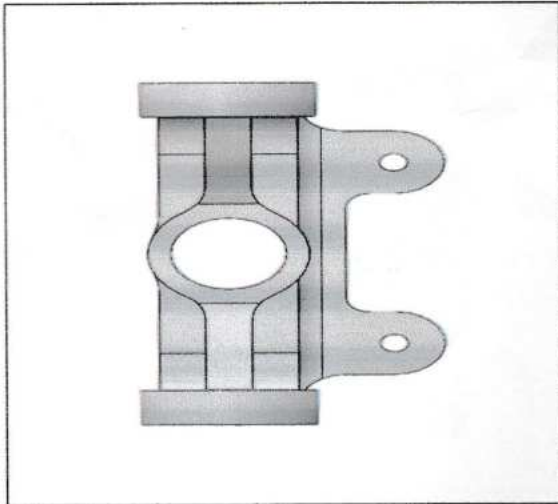

FRONT VIEW

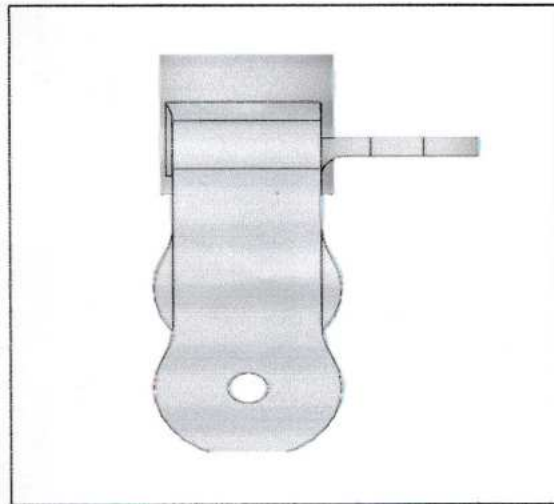

TOP VIEW

The novelty resides in the shape and configuration of the 'FRONT KNUCKLE' as illustrated.

~~A Front Knuckle is used in all terrain vehicle to control suspension and steering with lighter material to improve its performance.~~

No claim is made by virtue of this registration in respect of any mechanical or other action of the mechanism whatever or in respect of any mode or principle of construction of the article.

No claim is made by virtue of the registration to any right to the exclusive use of the words, letters, numbers, colour, combination or Trade Marks as appearing in the representation.

349843 -001

20 SEP 2021

Ms. DHARTI SHAH
(Authorized Agent of the Applicant)
(IN/PA- 2590)

(REPRESENTATION SHEETS)

NAME OF THE APPLICANT
NEJAL PATEL
MARUT PATEL

NO. OF SHEETS - 3
SHEET NO. - 3

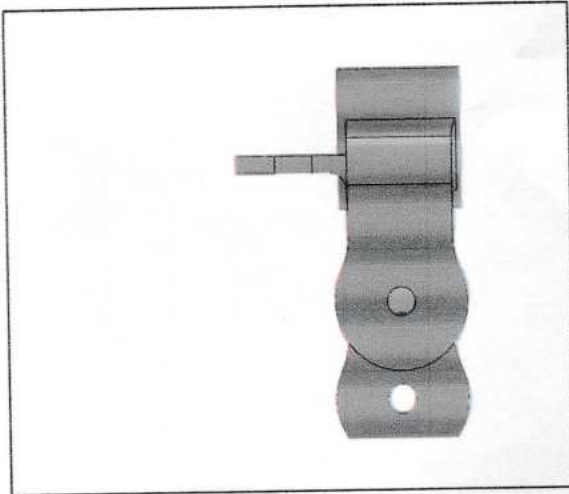

BOTTOM VIEW

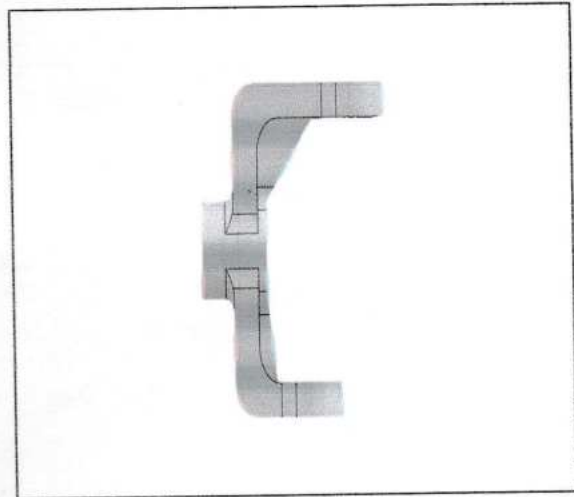

LEFT SIDE VIEW

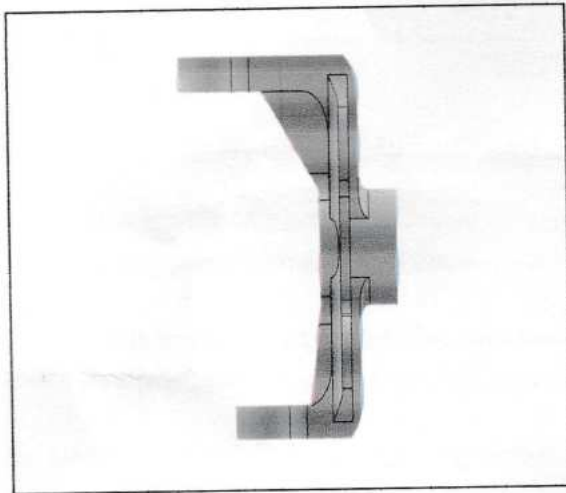

RIGHT SIDE VIEW

The novelty resides in the shape and configuration of the 'FRONT KNUCKLE' as illustrated.

~~A Front Knuckle is used in all terrain vehicle to control suspension and steering with lighter material to improve its performance.~~



No claim is made by virtue of this registration in respect of any mechanical or other action of the mechanism whatever or in respect of any mode or principle of construction of the article.

No claim is made by virtue of the registration to any right to the exclusive use of the words, letters, numbers, colour, combination or Trade Marks as appearing in the representation.

349843-001

20 SEP 2021

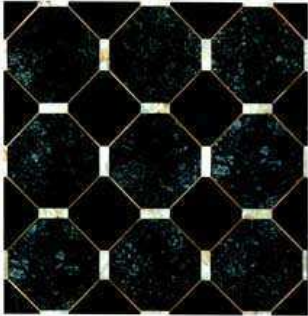
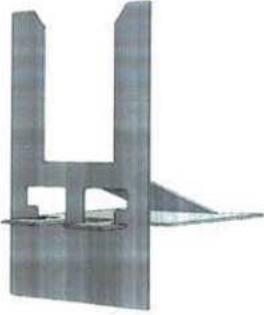
Ms. DHARTI SHAH
(Authorized Agent of the Applicant)
(IN/PA- 2590)

DESIGN NUMBER	349789-001	
CLASS	25-01	
SIRI MAHARAJA GRANTIES PRIVATE LIMITED, E-315A, VKIA AREA, ROAD NO. 16, SIKAR ROAD - JAIPUR - 302013, INDIA		
DATE OF REGISTRATION	20/09/2021	
TITLE	TILE	
PRIORITY NA		
DESIGN NUMBER	349836-001	
CLASS	14-06	
REVERGON SOLUTIONS PRIVATE LIMITED, A2, NILES CHS, PLOT NO. 22, SECTOR 14, VASHI NAVI MUMBAI - 400703, INDIA		
DATE OF REGISTRATION	20/09/2021	
TITLE	TABLET STAND	
PRIORITY NA		
DESIGN NUMBER	349843-001	
CLASS	12-16	
1.NEJAL PATEL, SILVER OAK UNIVERSITY CAMPUS, OPP. BHAGWAT VIDYAPITH, S.G ROAD, GOTA, AHMEDABAD - 382421 2. MARUT PATEL, SILVER OAK UNIVERSITY CAMPUS, OPP. BHAGWAT VIDYAPITH, S.G ROAD, GOTA, AHMEDABAD - 382421		
DATE OF REGISTRATION	20/09/2021	
TITLE	FRONT KNUCKLE	
PRIORITY NA		



सत्यमेव जयते

भारत सरकार
GOVERNMENT OF INDIA
पेटेंट कार्यालय
THE PATENT OFFICE

ORIGINAL

No. 104531

CERTIFICATE OF REGISTRATION OF DESIGN

Design No. 349852-001
Date 20/09/2021 20:16:25
Reciprocity Date*
Country

Certified that the design of which a copy is annexed hereto has been registered as of the number and date given above in class 12-16 in respect of the application of such design to ENGINE MOUNTING in the name of 1.RIPEN SHAH, SILVER OAK UNIVERSITY CAMPUS, OPP. BHAGWAT VIDYAPITH, S.G ROAD, GOTA, AHMEDABAD – 382421, INDIA, 2. MIT SHAH, SILVER OAK UNIVERSITY CAMPUS, OPP. BHAGWAT VIDYAPITH, S.G ROAD, GOTA, AHMEDABAD – 382421, INDIA.

in pursuance of and subject to the provisions of the Designs Act, 2000 and the Designs Rules, 2001.

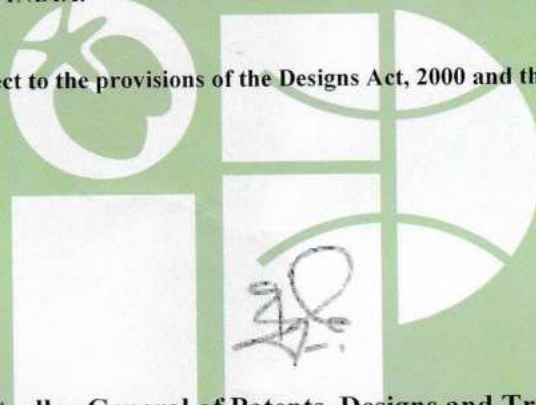

Controller General of Patents, Designs and Trade Marks

*The reciprocity date (if any) which has been allowed and the name of the country.

Copyright in the design will subsist for ten years from the date of Registration, and may under the terms of the Act and Rules, be extended for a further period of five years.

This Certificate is not for use in legal proceedings or for obtaining registration abroad

MS. DHARTI SHAH,
VERITE ASSOCIATES, 105, SCARLET GATEWAY, NR.
SPIPA ACADEMY, CORPORATE ROAD,
PRAHALADNAGR, AHMEDABAD-380015, GUJARAT,
INDIA

Date of Issue 10/11/2021 13:21:27

INTELLECTUAL
PROPERTY INDIA
PATENTS | DESIGNS | TRADE MARKS
GEOGRAPHICAL INDICATIONS

(REPRESENTATION SHEETS)

NAME OF THE APPLICANT
RIPEN SHAH
MIT SHAH

NO. OF SHEETS - 3
SHEET NO. - 1

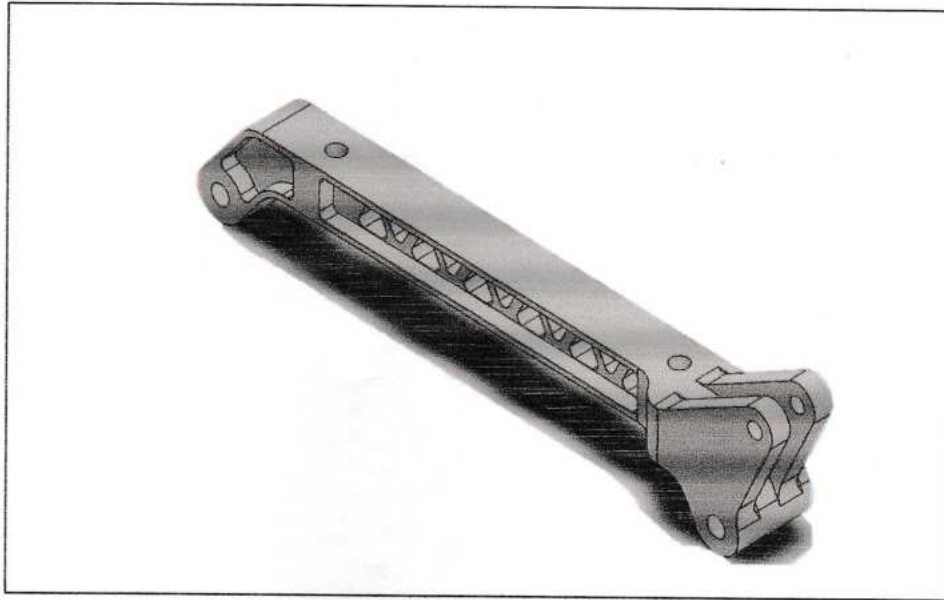

PERSPECTIVE VIEW

The novelty resides in the shape and configuration of the 'ENGINE MOUNTING' as illustrated.

[An engine mounting is specially designed with lighter material for all terrain vehicles to improve its performance and making it lighter in weight.]x

No claim is made by virtue of this registration in respect of any mechanical or other action of the mechanism whatever or in respect of any mode or principle of construction of the article.

No claim is made by virtue of the registration to any right to the exclusive use of the words, letters, numbers, colour, combination or Trade Marks, as appearing in the representation.

↓
and extraneous matter (Shadow)

349852-001
20 SEP 2021

Ms. DHARTI SHAH
(Authorized Agent of the Applicant)
(IN/PA- 2590)

(REPRESENTATION SHEETS)

NAME OF THE APPLICANT
RIPEN SHAH
MIT SHAH

NO. OF SHEETS - 3
SHEET NO. - 2

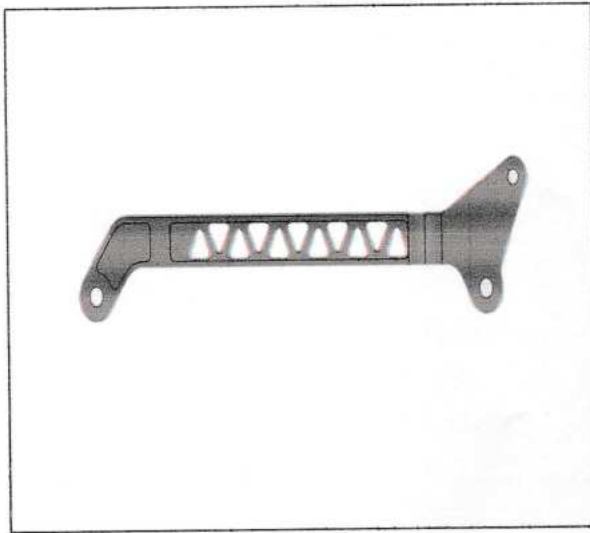

FRONT VIEW

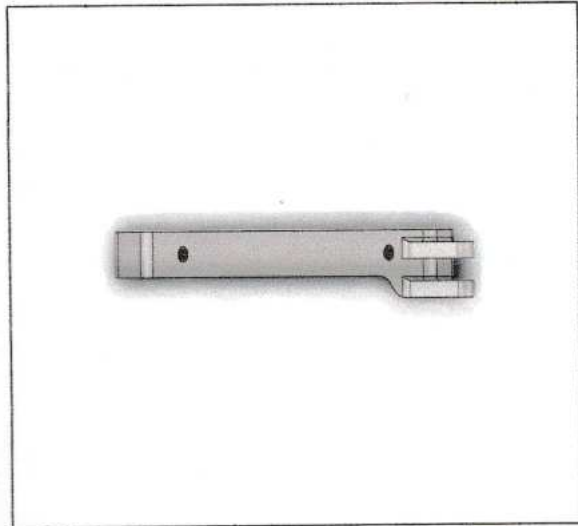

TOP VIEW

The novelty resides in the shape and configuration of the 'ENGINE MOUNTING' as illustrated.

[An engine mounting is specially designed with lighter material for all terrain vehicles to improve its performance and making it lighter in weight.] X

No claim is made by virtue of this registration in respect of any mechanical or other action of the mechanism whatever or in respect of any mode or principle of construction of the article.

No claim is made by virtue of the registration to any right to the exclusive use of the words, letters, numbers, colour, combination or Trade Marks as appearing in the representation.

and extraneous matter (Shadow)

349852-001
20 SEP 2021

Ms. DHARTI SHAH
(Authorized Agent of the Applicant)
(IN/PA- 2590)

(REPRESENTATION SHEETS)

NAME OF THE APPLICANT
RIPEN SHAH
MIT SHAH

NO. OF SHEETS - 3
SHEET NO. - 3

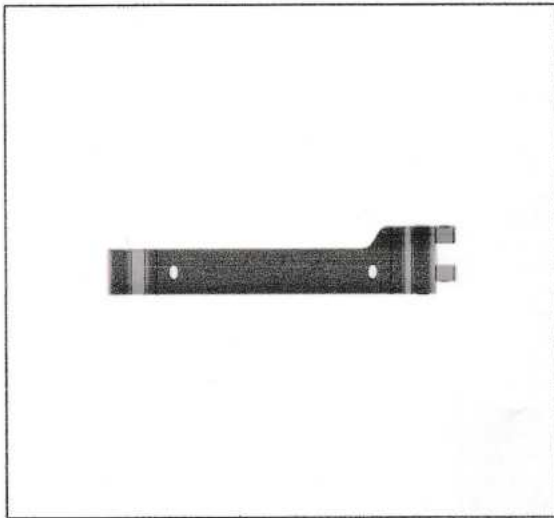

BOTTOM VIEW

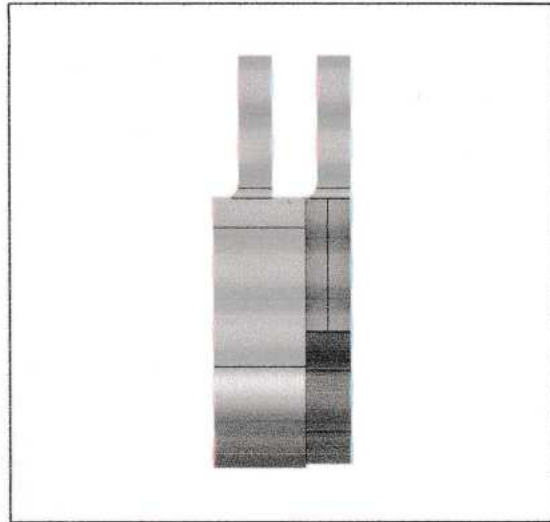

LEFT SIDE VIEW

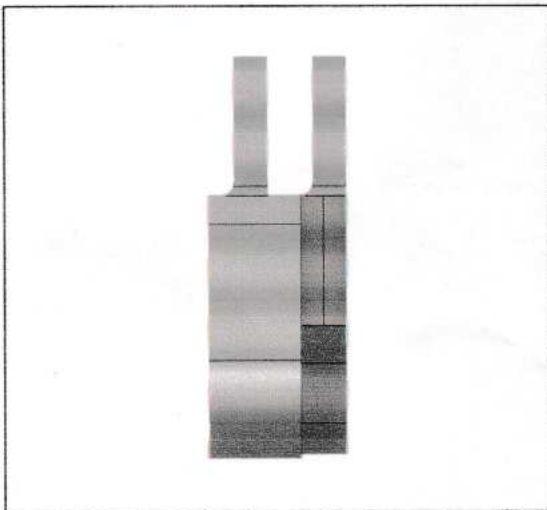

RIGHT SIDE VIEW

The novelty resides in the shape and configuration of the 'ENGINE MOUNTING' as illustrated.

An engine mounting is specially designed with lighter material for all terrain vehicles to improve its performance and making it lighter in weight. Jx

No claim is made by virtue of this registration in respect of any mechanical or other action of the mechanism whatever or in respect of any mode or principle of construction of the article.

No claim is made by virtue of the registration to any right to the exclusive use of the words, letters, numbers, colour, combination or Trade Marks, as appearing in the representation.

and extraneous matter (shadow)

349852-001

20 SEP 2021

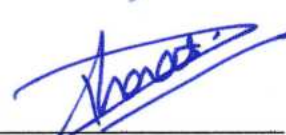
Ms. DHARTI SHAH
(Authorized Agent of the Applicant)
(IN/PA- 2590)

DESIGN NUMBER	337656-003	
CLASS	02-02	
VISHNUBHAI JIVRAMBHAI PATEL, 104, RAGHUVIR PLATINUM, NEAR SHYAM SANGINI MARKET, KUMBHARIA, SURAT-395010, INDIA		
DATE OF REGISTRATION	19/01/2021	
TITLE	SAREE AND BLOUSE (SET)	
PRIORITY NA		
DESIGN NUMBER	337681-001	
CLASS	12-11	
ARIHANT INDUSTRIES, K-269, PHASE-VIII, FOCAL POINT, LUDHIANA – 141 010 (PUNJAB) INDIA, WHOSE PROPRIETOR IS ANKUR JAIN		
DATE OF REGISTRATION	19/01/2021	
TITLE	PEDAL FOR BICYCLE	
PRIORITY NA		
DESIGN NUMBER	349852-001	
CLASS	12-16	
1.RIPEN SHAH, SILVER OAK UNIVERSITY CAMPUS, OPP. BHAGWAT VIDYAPITH, S.G ROAD, GOTA, AHMEDABAD – 382421, INDIA, 2. MIT SHAH, SILVER OAK UNIVERSITY CAMPUS, OPP. BHAGWAT VIDYAPITH, S.G ROAD, GOTA, AHMEDABAD – 382421, INDIA.		
DATE OF REGISTRATION	20/09/2021	
TITLE	ENGINE MOUNTING	
PRIORITY NA		



ORIGINAL

No. 105300

भारत सरकार
GOVERNMENT OF INDIA
पेटेंट कार्यालय
THE PATENT OFFICE

CERTIFICATE OF REGISTRATION OF DESIGN

Design No. 349853-001
Date 20/09/2021 20:16:25
Reciprocity Date*
Country

Certified that the design of which a copy is annexed hereto has been registered as of the number and date given above in class 12-16 in respect of the application of such design to FRONT HUB in the name of 1.RIPEN SHAH, SILVER OAK UNIVERSITY CAMPUS, OPP. BHAGWAT VIDYAPITH, S.G ROAD, GOTA, AHMEDABAD – 382421, INDIA 2. MIT SHAH, SILVER OAK UNIVERSITY CAMPUS, OPP. BHAGWAT VIDYAPITH, S.G ROAD, GOTA, AHMEDABAD – 382421, INDIA

in pursuance of and subject to the provisions of the Designs Act, 2000 and the Designs Rules, 2001.

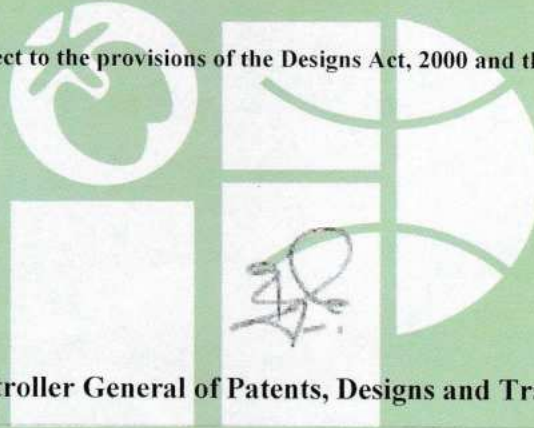

Controller General of Patents, Designs and Trade Marks

*The reciprocity date (if any) which has been allowed and the name of the country.

Copyright in the design will subsist for ten years from the date of Registration, and may under the terms of the Act and Rules, be extended for a further period of five years.

This Certificate is not for use in legal proceedings or for obtaining registration abroad

MS. DHARTI SHAH,
VERITE ASSOCIATES, 105, SCARLET GATEWAY, NR.
SPIPA ACADEMY, CORPORATE ROAD,
PRAHALADNAGR, AHMEDABAD-380015, GUJARAT,
INDIA

INTELLECTUAL
PROPERTY INDIA
DESIGNS | TRADE MARKS
GEOGRAPHICAL INDICATIONS

Date of Issue 29/11/2021 11:33:14

(REPRESENTATION SHEETS)

NAME OF THE APPLICANT
RIPEN SHAH
MIT SHAH

NO. OF SHEETS - 3
SHEET NO. - 1

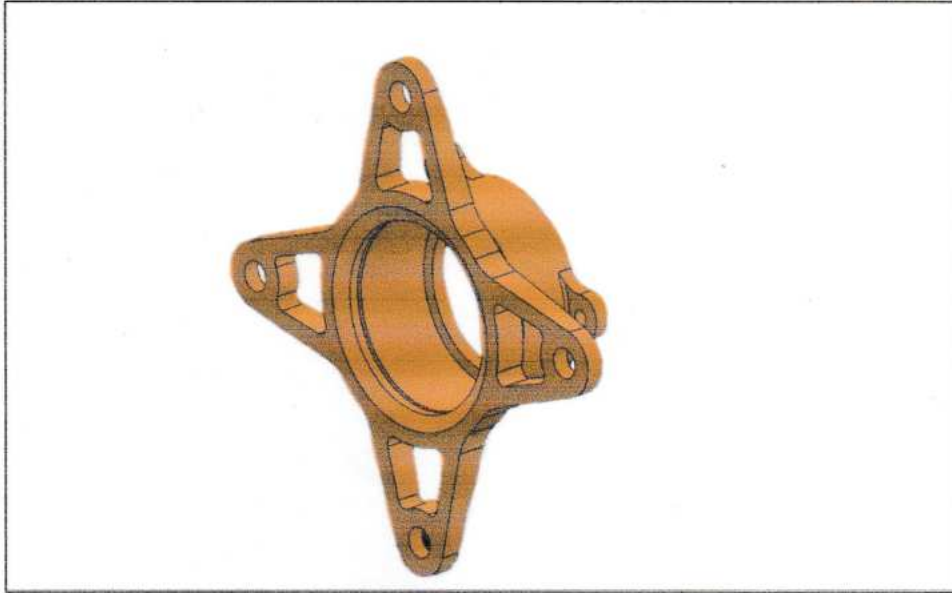

PERSPECTIVE VIEW

The novelty resides in the shape and configuration of the 'FRONT HUB' as illustrated.

~~A Front Wheel Hub is used for all terrain vehicle with lighter material to improve its performance.~~

No claim is made by virtue of this registration in respect of any mechanical or other action of the mechanism whatever or in respect of any mode or principle of construction of the article.

No claim is made by virtue of the registration to any right to the exclusive use of the words, letters, numbers, colour, combination or Trade Marks as appearing in the representation.

349853-001

20 SEP 2021

Ms. DHARTI SHAH
(Authorized Agent of the Applicant)
(IN/PA- 2590)

(REPRESENTATION SHEETS)

NAME OF THE APPLICANT
RIPEN SHAH
MIT SHAH

NO. OF SHEETS - 3
SHEET NO. - 2

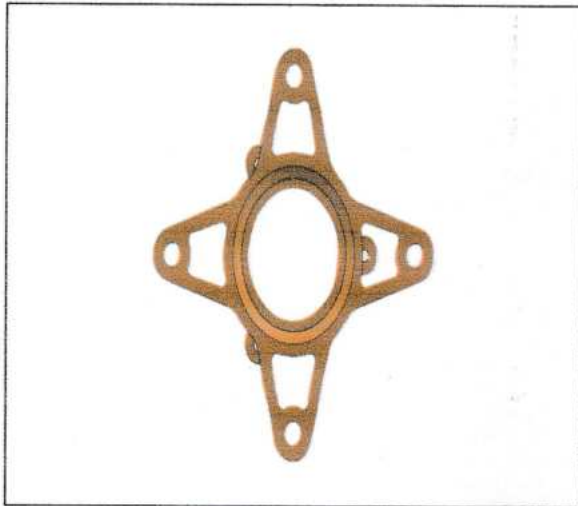

FRONT VIEW

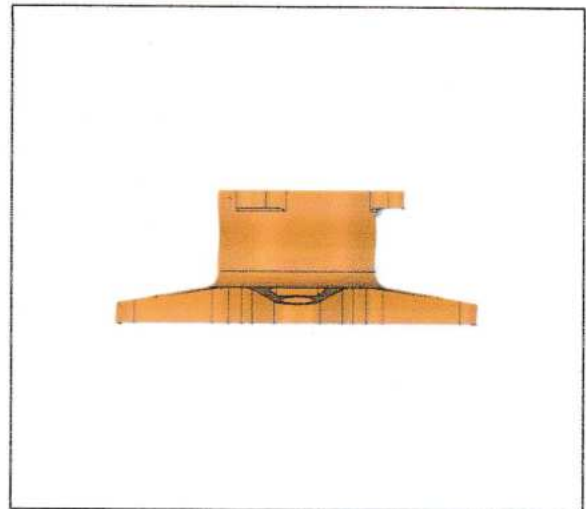

TOP VIEW

The novelty resides in the shape and configuration of the 'FRONT HUB' as illustrated.

~~A Front Wheel Hub is used for all-terrain vehicle with lighter material to improve its performance.~~

No claim is made by virtue of this registration in respect of any mechanical or other action of the mechanism whatever or in respect of any mode or principle of construction of the article.

No claim is made by virtue of the registration to any right to the exclusive use of the words, letters, numbers, colour, combination or Trade Marks as appearing in the representation.

349853-001

20 SEP 2021



Ms. DHARTI SHAH
(Authorized Agent of the Applicant)
(IN/PA- 2590)

(REPRESENTATION SHEETS)

NAME OF THE APPLICANT
RIPEN SHAH
MIT SHAH

NO. OF SHEETS - 3
SHEET NO. - 3



BOTTOM VIEW

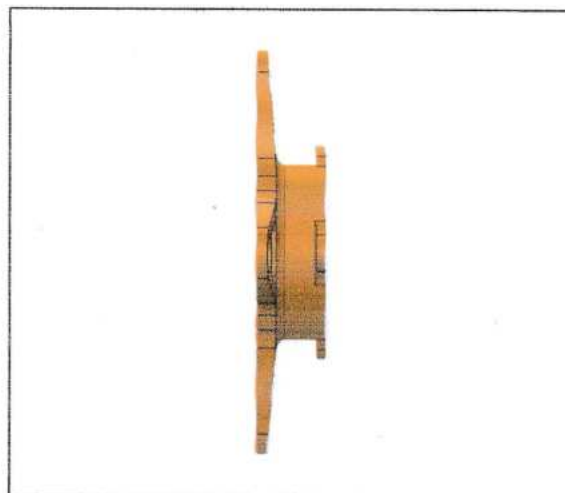

LEFT SIDE VIEW

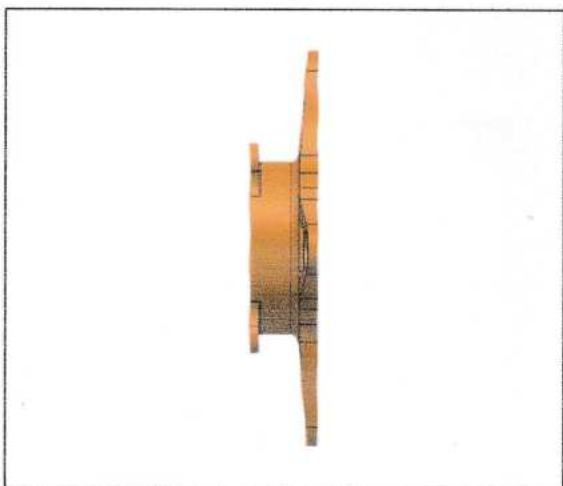

RIGHT SIDE VIEW

The novelty resides in the shape and configuration of the 'FRONT HUB' as illustrated.



~~A Front Wheel Hub is used for all terrain vehicle with lighter material to improve its performance.~~

No claim is made by virtue of this registration in respect of any mechanical or other action of the mechanism whatever or in respect of any mode or principle of construction of the article.

No claim is made by virtue of the registration to any right to the exclusive use of the words, letters, numbers, colour, combination or Trade Marks as appearing in the representation.

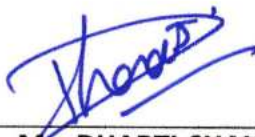
349853-001
20 SEP 2021

Ms. DHARTI SHAH
(Authorized Agent of the Applicant)
(IN/PA- 2590)

DESIGN NUMBER	337175-001	
CLASS	24-01	
SWAMI RAMA HIMALAYAN UNIVERSITY (SRHU), SWAMI RAM NAGAR, JOLLY GRANT, DEHRADUN, UTTARAKHAND, INDIA-248016		
DATE OF REGISTRATION	04/01/2021	
TITLE	VERTEX PERIMETRY DEVICE	
PRIORITY NA		
DESIGN NUMBER	337188-001	
CLASS	23-01	
SPRING BIRD POLYTECH, C - 37, ROAD NO. 9, GIDC ODHAV, AHMEDABAD - 382415, GUJARAT - INDIA, WHOSE PROPRIETOR IS PRATIK S. PATEL		
DATE OF REGISTRATION	04/01/2021	
TITLE	NOZZEL FOR IRRIGATION	
PRIORITY NA		
DESIGN NUMBER	349853-001	
CLASS	12-16	
1.RIPEN SHAH, SILVER OAK UNIVERSITY CAMPUS, OPP. BHAGWAT VIDYAPITH, S.G ROAD, GOTA, AHMEDABAD – 382421, INDIA 2. MIT SHAH, SILVER OAK UNIVERSITY CAMPUS, OPP. BHAGWAT VIDYAPITH, S.G ROAD, GOTA, AHMEDABAD – 382421, INDIA		
DATE OF REGISTRATION	20/09/2021	
TITLE	FRONT HUB	
PRIORITY NA		



ORIGINAL

No. 105342

भारत सरकार
GOVERNMENT OF INDIA
पेटेंट कार्यालय
THE PATENT OFFICE

CERTIFICATE OF REGISTRATION OF DESIGN

Design No. 350660-001
Date 04/10/2021 19:51:10
Reciprocity Date* 00:00:00
Country

Certified that the design of which a copy is annexed hereto has been registered as of the number and date given above in class 12-11 in respect of the application of such design to REAR BRAKE DISC in the name of 1.VIRAT DHOLAKIYA, SILVER OAK UNIVERSITY CAMPUS, OPP. BHAGWAT VIDYAPITH, S.G ROAD, GOTTA, AHMEDABAD – 382421, INDIA 2. ISHAN THAKAR, SILVER OAK UNIVERSITY CAMPUS, OPP. BHAGWAT VIDYAPITH, S.G ROAD, GOTTA, AHMEDABAD – 382421, INDIA

in pursuance of and subject to the provisions of the Designs Act, 2000 and the Designs Rules, 2001.

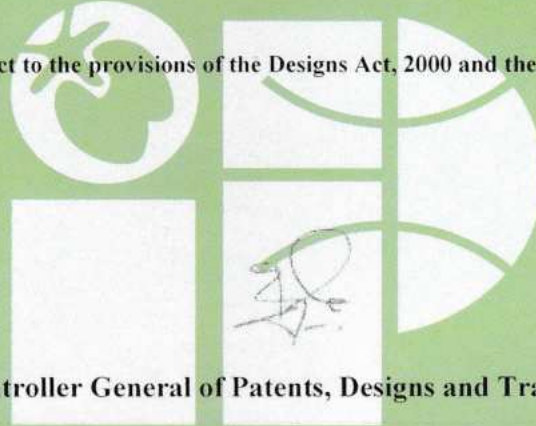

Controller General of Patents, Designs and Trade Marks

*The reciprocity date (if any) which has been allowed and the name of the country.

Copyright in the design will subsist for ten years from the date of Registration, and may under the terms of the Act and Rules, be extended for a further period of five years.

This Certificate is not for use in legal proceedings or for obtaining registration abroad

MS. DHARTI SHAH,
VERITE ASSOCIATES, 105, SCARLET GATEWAY, NR.
SPIPA ACADEMY, CORPORATE ROAD,
PRAHALADNAGR, AHMEDABAD-380015, GUJARAT,
INDIA

INTELLECTUAL
PROPERTY INDIA
DESIGNS | TRADE MARKS
GEOGRAPHICAL INDICATIONS

Date of Issue 01/12/2021 16:01:53
NF

(REPRESENTATION SHEETS)

NAME OF THE APPLICANT
VIRAT DHOLAKIYA
ISHAN THAKAR

NO. OF SHEETS - 3
SHEET NO. - 1

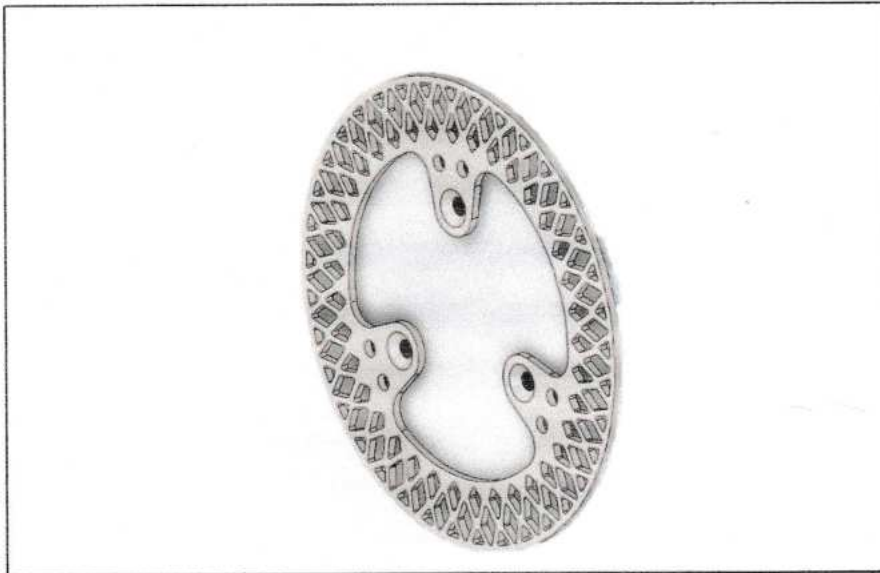

PERSPECTIVE VIEW

The novelty resides in the shape and configuration of the 'REAR BRAKE DISC' as illustrated.

A Rear Brake Disc is used in all-terrain vehicle to improve its braking performance.

No claim is made by virtue of this registration in respect of any mechanical or other action of the mechanism whatever or in respect of any mode or principle of construction of the article.

No claim is made by virtue of the registration to any right to the exclusive use of the words, letters, numbers, colour, combination or Trade Marks as appearing in the representation.

350660-001

04 OCT 2021

Ms. DHARTI SHAH
(Authorized Agent of the Applicant)
(IN/PA- 2590)

(REPRESENTATION SHEETS)

NAME OF THE APPLICANT
VIRAT DHOLAKIYA
ISHAN THAKAR

NO. OF SHEETS - 3
SHEET NO. - 2

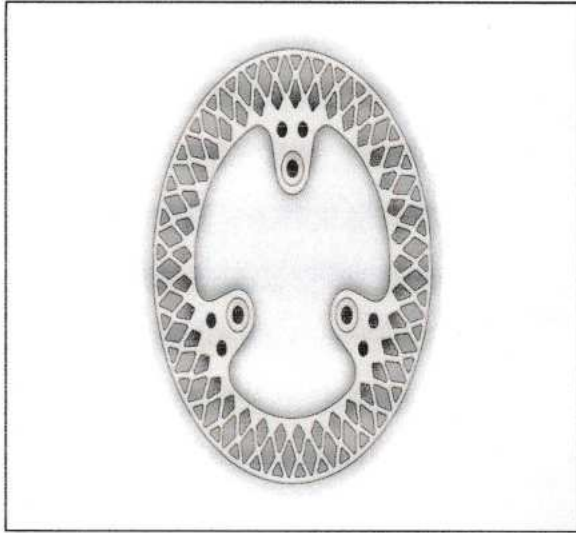

FRONT VIEW



TOP VIEW

The novelty resides in the shape and configuration of the '**REAR BRAKE DISC**' as illustrated.

A Rear Brake Disc is used in all-terrain vehicle to improve its braking performance.

No claim is made by virtue of this registration in respect of any mechanical or other action of the mechanism whatever or in respect of any mode or principle of construction of the article.

No claim is made by virtue of the registration to any right to the exclusive use of the words, letters, numbers, colour, combination or Trade Marks as appearing in the representation.

350660-001

04 OCT 2021

Ms. DHARTI SHAH
(Authorized Agent of the Applicant)
(IN/PA- 2590)

(REPRESENTATION SHEETS)

NAME OF THE APPLICANT
VIRAT DHOLAKIYA
ISHAN THAKAR

NO. OF SHEETS - 3
SHEET NO. - 3

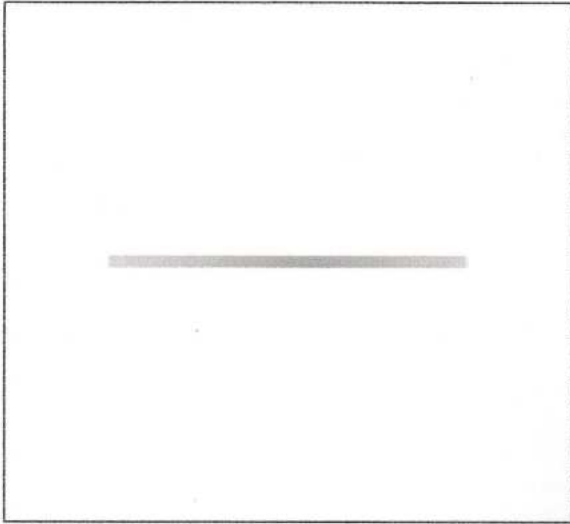

BOTTOM VIEW

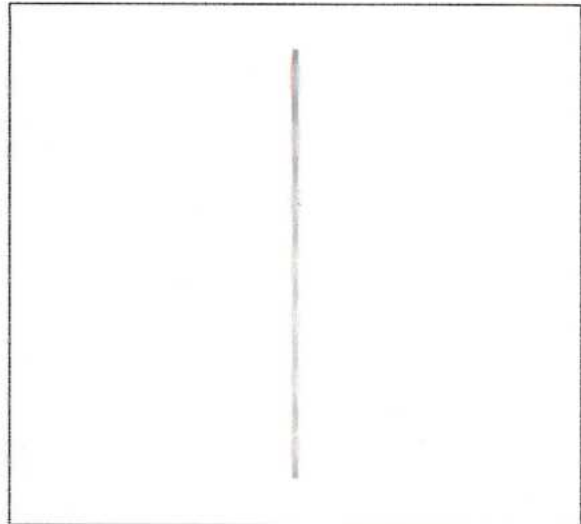

LEFT SIDE VIEW

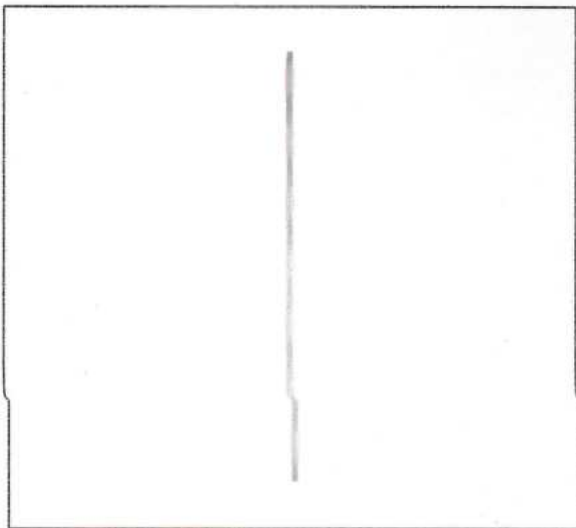

RIGHT SIDE VIEW

The novelty resides in the shape and configuration of the '**REAR BRAKE DISC**' as illustrated.

A Rear Brake Disc is used in all-terrain vehicle to improve its braking performance.

No claim is made by virtue of this registration in respect of any mechanical or other action of the mechanism whatever or in respect of any mode or principle of construction of the article.

No claim is made by virtue of the registration to any right to the exclusive use of the words, letters, numbers, colour, combination or Trade Marks as appearing in the representation.

350660 - 001

04 OCT 2021

Ms. DHARTI SHAH
(Authorized Agent of the Applicant)
(IN/PA- 2590)

DESIGN NUMBER	350636-002	
CLASS	02-02	
ASHISH DHIRUBHAI SORTHIYA, FANTASY FAB, 2ND FLOOR, 2001, SHREE KUBERJI TEXTILE WORLD, SAROLI, SURAT-395010, GUJARAT (INDIA)		
DATE OF REGISTRATION	04/10/2021	
TITLE	LADIES GARMENT (KURTI)	
PRIORITY NA		
DESIGN NUMBER	350650-001	
CLASS	12-16	
1.RIPEN SHAH, SILVER OAK UNIVERSITY CAMPUS, OPP. BHAGWAT VIDYAPITH, S.G ROAD, GOTA, AHMEDABAD – 382421 2. MIT SHAH, SILVER OAK UNIVERSITY CAMPUS, OPP. BHAGWAT VIDYAPITH, S.G ROAD, GOTA, AHMEDABAD – 382421		
DATE OF REGISTRATION	04/10/2021	
TITLE	ENGINE MOUNTING (SET)	
PRIORITY NA		
DESIGN NUMBER	350660-001	
CLASS	12-11	
1.VIRAT DHOLAKIYA, SILVER OAK UNIVERSITY CAMPUS, OPP. BHAGWAT VIDYAPITH, S.G ROAD, GOTA, AHMEDABAD – 382421, INDIA 2. ISHAN THAKAR, SILVER OAK UNIVERSITY CAMPUS, OPP. BHAGWAT VIDYAPITH, S.G ROAD, GOTA, AHMEDABAD – 382421, INDIA		
DATE OF REGISTRATION	04/10/2021	
TITLE	REAR BRAKE DISC	
PRIORITY NA		



ORIGINAL

No. 105355

भारत सरकार
GOVERNMENT OF INDIA
पेटेंट कार्यालय
THE PATENT OFFICE

CERTIFICATE OF REGISTRATION OF DESIGN

Design No. 350650-001
Date 04/10/2021
Reciprocity Date*
Country

Certified that the design of which a copy is annexed hereto has been registered as of the number and date given above in class 12-16 in respect of the application of such design to ENGINE MOUNTING (SET) in the name of 1.RIPEN SHAH, SILVER OAK UNIVERSITY CAMPUS, OPP. BHAGWAT VIDYAPITH, S.G ROAD, GOTA, AHMEDABAD – 382421 2. MIT SHAH, SILVER OAK UNIVERSITY CAMPUS, OPP. BHAGWAT VIDYAPITH, S.G ROAD, GOTA, AHMEDABAD – 382421

in pursuance of and subject to the provisions of the Designs Act, 2000 and the Designs Rules, 2001.

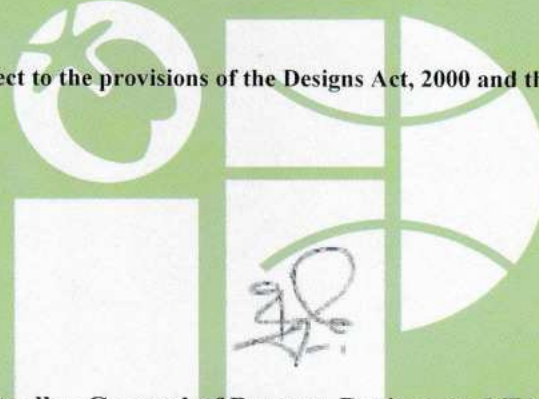

Controller General of Patents, Designs and Trade Marks

*The reciprocity date (if any) which has been allowed and the name of the country.

Copyright in the design will subsist for ten years from the date of Registration, and may under the terms of the Act and Rules, be extended for a further period of five years.

This Certificate is not for use in legal proceedings or for obtaining registration abroad

MS. DHARTI SHAH,
VERITE ASSOCIATES, 105, SCARLET GATEWAY, NR.
SPIPA ACADEMY, CORPORATE ROAD,
PRAHALADNAGR, AHMEDABAD-380015, GUJARAT,
INDIA

INTELLECTUAL
PROPERTY INDIA
DESIGNS | TRADE MARKS
GEOGRAPHICAL INDICATIONS

Date of Issue 29/11/2021 16:12:41

(REPRESENTATION SHEETS)

NAME OF THE APPLICANT
RIPEN SHAH
MIT SHAH

NO. OF SHEETS - 3
SHEET NO. - 1



PERSPECTIVE VIEW

The novelty resides in the shape and configuration of the 'ENGINE MOUNTING' as illustrated. ^(SET)

An engine mounting is specially designed with lighter material for all terrain vehicles to improve its performance and making it lighter in weight.

No claim is made by virtue of this registration in respect of any mechanical or other action of the mechanism whatever or in respect of any mode or principle of construction of the article.

No claim is made by virtue of the registration to any right to the exclusive use of the words, letters, numbers, colour, combination or Trade Marks as appearing in the representation.

350650-001
04 OCT 2021

Ms. DHARTI SHAH
(Authorized Agent of the Applicant)
(IN/PA- 2590)

(REPRESENTATION SHEETS)

NAME OF THE APPLICANT
RIPEN SHAH
MIT SHAH

NO. OF SHEETS - 3
SHEET NO. - 2



FRONT VIEW

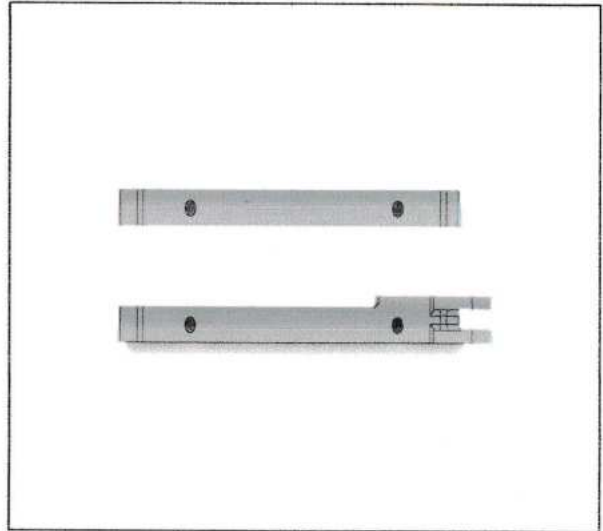

TOP VIEW

The novelty resides in the shape and configuration of the 'ENGINE MOUNTING' ^{GETD} as illustrated.

An engine mounting is specially designed with lighter material ~~for all terrain vehicles to~~ improve its performance and making it lighter in weight.

No claim is made by virtue of this registration in respect of any mechanical or other action of the mechanism whatever or in respect of any mode or principle of construction of the article.

No claim is made by virtue of the registration to any right to the exclusive use of the words, letters, numbers, colour, combination or Trade Marks as appearing in the representation.

350650 - 001

04 OCT 2021

Ms. DHARTI SHAH
(Authorized Agent of the Applicant)
(IN/PA- 2590)

(REPRESENTATION SHEETS)

NAME OF THE APPLICANT
RIPEN SHAH
MIT SHAH

NO. OF SHEETS - 3
SHEET NO. - 3



BOTTOM VIEW

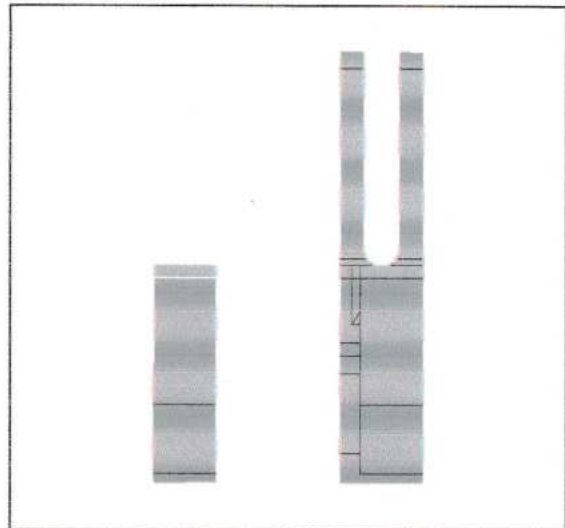

LEFT SIDE VIEW

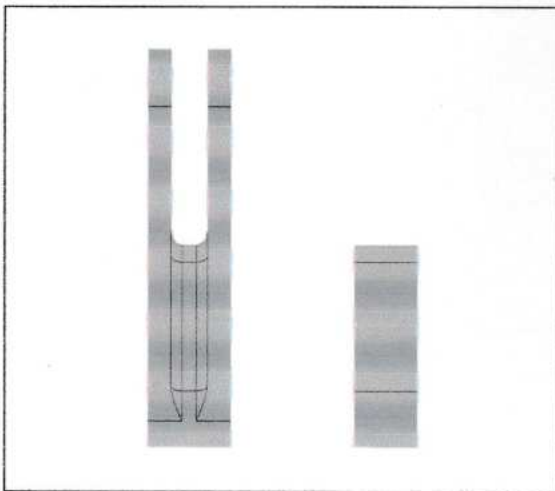

RIGHT SIDE VIEW

The novelty resides in the shape and configuration of the '**ENGINE MOUNTING**'^(SET) as illustrated.

An engine mounting is specially designed with lighter material for all terrain vehicles to improve its performance and making it lighter in weight.

No claim is made by virtue of this registration in respect of any mechanical or other action of the mechanism whatever or in respect of any mode or principle of construction of the article.

No claim is made by virtue of the registration to any right to the exclusive use of the words, letters, numbers, colour, combination or Trade Marks as appearing in the representation.

350850 - 001

04 OCT 2021

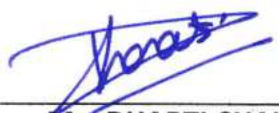
Ms. DHARTI SHAH
(Authorized Agent of the Applicant)
(IN/PA- 2590)

DESIGN NUMBER	350636-002	
CLASS	02-02	
ASHISH DHIRUBHAI SORTHIYA, FANTASY FAB, 2ND FLOOR, 2001, SHREE KUBERJI TEXTILE WORLD, SAROLI, SURAT-395010, GUJARAT (INDIA)		
DATE OF REGISTRATION	04/10/2021	
TITLE	LADIES GARMENT (KURTI)	
PRIORITY NA		
DESIGN NUMBER	350650-001	
CLASS	12-16	
1.RIPEN SHAH, SILVER OAK UNIVERSITY CAMPUS, OPP. BHAGWAT VIDYAPITH, S.G ROAD, GOTA, AHMEDABAD – 382421 2. MIT SHAH, SILVER OAK UNIVERSITY CAMPUS, OPP. BHAGWAT VIDYAPITH, S.G ROAD, GOTA, AHMEDABAD – 382421		
DATE OF REGISTRATION	04/10/2021	
TITLE	ENGINE MOUNTING (SET)	
PRIORITY NA		
DESIGN NUMBER	350660-001	
CLASS	12-11	
1.VIRAT DHOLAKIYA, SILVER OAK UNIVERSITY CAMPUS, OPP. BHAGWAT VIDYAPITH, S.G ROAD, GOTA, AHMEDABAD – 382421, INDIA 2. ISHAN THAKAR, SILVER OAK UNIVERSITY CAMPUS, OPP. BHAGWAT VIDYAPITH, S.G ROAD, GOTA, AHMEDABAD – 382421, INDIA		
DATE OF REGISTRATION	04/10/2021	
TITLE	REAR BRAKE DISC	
PRIORITY NA		



सत्यमेव जयते

भारत सरकार
GOVERNMENT OF INDIA
पेटेंट कार्यालय
THE PATENT OFFICE

ORIGINAL

No. 105533

CERTIFICATE OF REGISTRATION OF DESIGN

Design No. 350651-001
Date 04/10/2021 19:51:10
Reciprocity Date*
Country

Certified that the design of which a copy is annexed hereto has been registered as of the number and date given above in class 12-16 in respect of the application of such design to FRONT DISC BRAKE in the name of I.HIMANSHU VAGHELA, SILVER OAK UNIVERSITY CAMPUS, OPP. BHAGWAT VIDYAPITH, S.G ROAD, GOTA, AHMEDABAD - 382421 2. ISHAN THAKAR, SILVER OAK UNIVERSITY CAMPUS, OPP. BHAGWAT VIDYAPITH, S.G ROAD, GOTA, AHMEDABAD - 382421

in pursuance of and subject to the provisions of the Designs Act, 2000 and the Designs Rules, 2001.

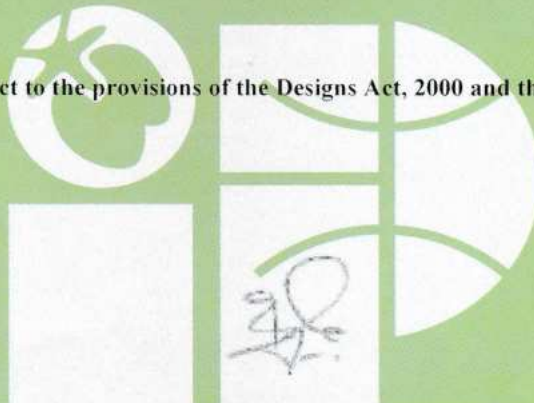

Controller General of Patents, Designs and Trade Marks

*The reciprocity date (if any) which has been allowed and the name of the country.

Copyright in the design will subsist for ten years from the date of Registration, and may under the terms of the Act and Rules, be extended for a further period of five years.

This Certificate is not for use in legal proceedings or for obtaining registration abroad

MS. DHARTI SHAH,
VERITE ASSOCIATES, 105, SCARLET GATEWAY, NR.
SPIPA ACADEMY, CORPORATE ROAD,
PRAHALADNAGR, AHMEDABAD-380015, GUJARAT,
INDIA

INTELLECTUAL
PROPERTY INDIA
PATENTS | DESIGNS | TRADE MARKS
GEOGRAPHICAL INDICATIONS

Date of Issue 03/12/2021 12:00:32

(REPRESENTATION SHEETS)

NAME OF THE APPLICANT
HIMANSHU VAGHELA
ISHAN THAKAR

NO. OF SHEETS - 3
SHEET NO. - 1

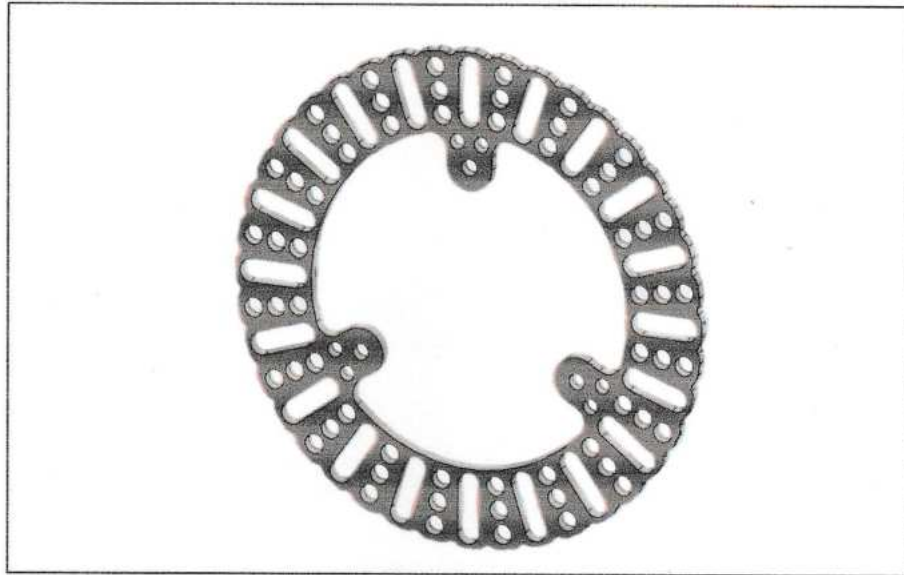

PERSPECTIVE VIEW

The novelty resides in the shape and configuration of the 'FRONT DISC BRAKE' as illustrated.

A Front Disc Brake is used in all-terrain vehicle to improve its braking performance.

No claim is made by virtue of this registration in respect of any mechanical or other action of the mechanism whatever or in respect of any mode or principle of construction of the article.

No claim is made by virtue of the registration to any right to the exclusive use of the words, letters, numbers, colour, combination or Trade Marks as appearing in the representation.

350651-001

04 OCT 2021

Ms. DHARTI SHAH
(Authorized Agent of the Applicant)
(IN/PA- 2590)

(REPRESENTATION SHEETS)

NAME OF THE APPLICANT
HIMANSHU VAGHELA
ISHAN THAKAR

NO. OF SHEETS - 3
SHEET NO. - 2

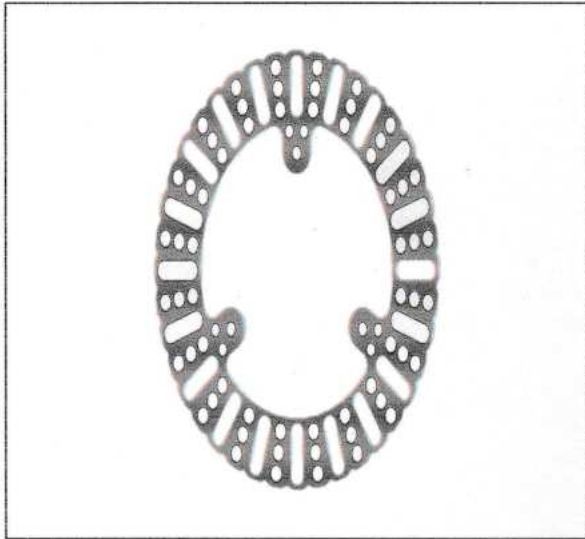

FRONT VIEW



TOP VIEW

The novelty resides in the shape and configuration of the 'FRONT DISC BRAKE' as illustrated.

A Front Disc Brake is used in all-terrain vehicle to improve its braking performance.

No claim is made by virtue of this registration in respect of any mechanical or other action of the mechanism whatever or in respect of any mode or principle of construction of the article.

No claim is made by virtue of the registration to any right to the exclusive use of the words, letters, numbers, colour, combination or Trade Marks as appearing in the representation.

350651-001

04 OCT 2021



Ms. DHARTI SHAH
(Authorized Agent of the Applicant)
(IN/PA- 2590)

(REPRESENTATION SHEETS)

NAME OF THE APPLICANT
HIMANSHU VAGHELA
ISHAN THAKAR

NO. OF SHEETS - 3
SHEET NO. - 3



BOTTOM VIEW



LEFT SIDE VIEW



RIGHT SIDE VIEW

The novelty resides in the shape and configuration of the 'FRONT DISC BRAKE' as illustrated.



A Front Disc Brake is used in all-terrain vehicle to improve its braking performance.

No claim is made by virtue of this registration in respect of any mechanical or other action of the mechanism whatever or in respect of any mode or principle of construction of the article.

No claim is made by virtue of the registration to any right to the exclusive use of the words, letters, numbers, colour, combination or Trade Marks as appearing in the representation.

350651-001
04 OCT 2021

Ms. DHARTI SHAH
(Authorized Agent of the Applicant)
(IN/PA- 2590)

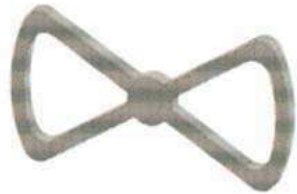
DESIGN NUMBER	350636-001	
CLASS	02-02	
ASHISH DHIRUBHAI SORTHIYA, FANTASY FAB, 2ND FLOOR, 2001, SHREE KUBERJI TEXTILE WORLD, SAROLI, SURAT-395010, GUJARAT		
DATE OF REGISTRATION	04/10/2021	
TITLE	LADIES GARMENT (KURTI)	
PRIORITY NA		
DESIGN NUMBER	350651-001	
CLASS	12-16	
1.HIMANSHU VAGHELA, SILVER OAK UNIVERSITY CAMPUS, OPP. BHAGWAT VIDYAPITH, S.G ROAD, GOTA, AHMEDABAD – 382421 2. ISHAN THAKAR, SILVER OAK UNIVERSITY CAMPUS, OPP. BHAGWAT VIDYAPITH, S.G ROAD, GOTA, AHMEDABAD – 382421		
DATE OF REGISTRATION	04/10/2021	
TITLE	FRONT DISC BRAKE	
PRIORITY NA		
DESIGN NUMBER	350659-001	
CLASS	12-16	
1.VENISH SUTHAR, SILVER OAK UNIVERSITY CAMPUS, OPP. BHAGWAT VIDYAPITH, S.G ROAD, GOTA, AHMEDABAD – 382421 2. ISHAN THAKAR, SILVER OAK UNIVERSITY CAMPUS, OPP. BHAGWAT VIDYAPITH, S.G ROAD, GOTA, AHMEDABAD – 382421		
DATE OF REGISTRATION	04/10/2021	
TITLE	STEERING WHEEL	
PRIORITY NA		



ORIGINAL

No. 104395

भारत सरकार
GOVERNMENT OF INDIA
पेटेंट कार्यालय
THE PATENT OFFICE

CERTIFICATE OF REGISTRATION OF DESIGN

Design No. 348961-001
Date 06/09/2021 17:02:25
Reciprocity Date*
Country

Certified that the design of which a copy is annexed hereto has been registered as of the number and date given above in class 12-16 in respect of the application of such design to DRIVE AXLE in the name of I.BHAVDEEP RAMESHBHAI TRIVEDI, SILVER OAK UNIVERSITY CAMPUS, OPP. BHAGWAT VIDYAPITH, S.G ROAD, GOTA, AHMEDABAD - 382421 2. VIRAT DHOLAKIYA, SILVER OAK UNIVERSITY CAMPUS, OPP. BHAGWAT VIDYAPITH, S.G ROAD, GOTA, AHMEDABAD - 382421

in pursuance of and subject to the provisions of the Designs Act, 2000 and the Designs Rules, 2001.

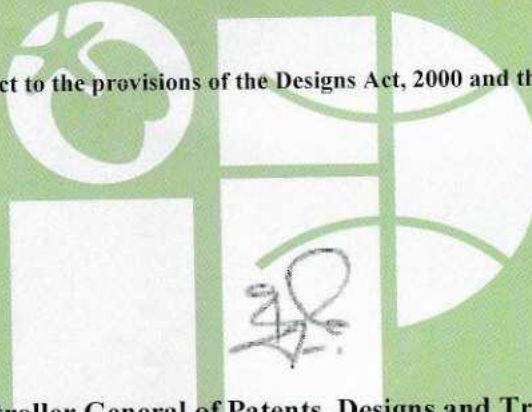



Controller General of Patents, Designs and Trade Marks

*The reciprocity date (if any) which has been allowed and the name of the country.
Copyright in the design will subsist for ten years from the date of Registration, and may under the terms of the Act and Rules, be extended for a further period of five years.
This Certificate is not for use in legal proceedings or for obtaining registration abroad

DR. DHARTI SHAH,
VERITE ASSOCIATES, 105, SCARLET GATEWAY, NR.
SPIPA ACADEMY, CORPORATE ROAD,
PRAHALADNAGR, AHMEDABAD-380015, GUJARAT,
INDIA

Date of Issue 08/11/2021 13:20:13

INTELLECTUAL
PROPERTY INDIA
PATENTS | DESIGNS | TRADE MARKS
GEOGRAPHICAL INDICATIONS

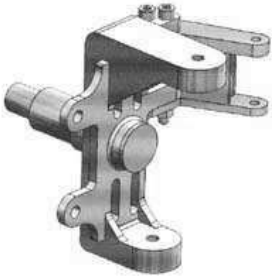
DESIGN NUMBER	339855-001	
CLASS	02-02	
ITALIYA JEMISH SHANTIBHAI, MAIN BAZAR, NAVAPARA, NAGDHANIBA, DIS.- BHAVNAGAR-364050.		
DATE OF REGISTRATION	26/02/2021	
TITLE	GHAGHRA CHOLI WITH DUPATTA (SET)	
PRIORITY NA		
DESIGN NUMBER	348961-001	
CLASS	12-16	
1. BHAVDEEP RAMESHBHAI TRIVEDI, SILVER OAK UNIVERSITY CAMPUS, OPP. BHAGWAT VIDYAPITH, S.G ROAD, GOTA, AHMEDABAD - 382421 2. VIRAT DHOLAKIYA, SILVER OAK UNIVERSITY CAMPUS, OPP. BHAGWAT VIDYAPITH, S.G ROAD, GOTA, AHMEDABAD - 382421		
DATE OF REGISTRATION	06/09/2021	
TITLE	DRIVE AXLE	
PRIORITY NA		
DESIGN NUMBER	348962-001	
CLASS	12-16	
1. MIT SHAH, SILVER OAK UNIVERSITY CAMPUS, OPP. BHAGWAT VIDYAPITH, S.G ROAD, GOTA, AHMEDABAD - 382421, INDIA, 2. RIPEN SHAH, SILVER OAK UNIVERSITY CAMPUS, OPP. BHAGWAT VIDYAPITH, S.G ROAD, GOTA, AHMEDABAD - 382421, INDIA.		
DATE OF REGISTRATION	06/09/2021	
TITLE	FRONT KNUCKLE	
PRIORITY NA		



ORIGINAL

No. 106108

भारत सरकार
GOVERNMENT OF INDIA
पेटेंट कार्यालय
THE PATENT OFFICE

CERTIFICATE OF REGISTRATION OF DESIGN

Design No. 350652-001
Date 04/10/2021 19:51:10
Reciprocity Date*
Country

Certified that the design of which a copy is annexed hereto has been registered as of the number and date given above in class 12-16 in respect of the application of such design to FRONT HUB in the name of I.RIPEN SHAH, SILVER OAK UNIVERSITY CAMPUS, OPP. BHAGWAT VIDYAPITH, S.G ROAD, GOTTA, AHMEDABAD – 382421 2. MIT SHAH, SILVER OAK UNIVERSITY CAMPUS, OPP. BHAGWAT VIDYAPITH, S.G ROAD, GOTTA, AHMEDABAD – 382421

in pursuance of and subject to the provisions of the Designs Act, 2000 and the Designs Rules, 2001.

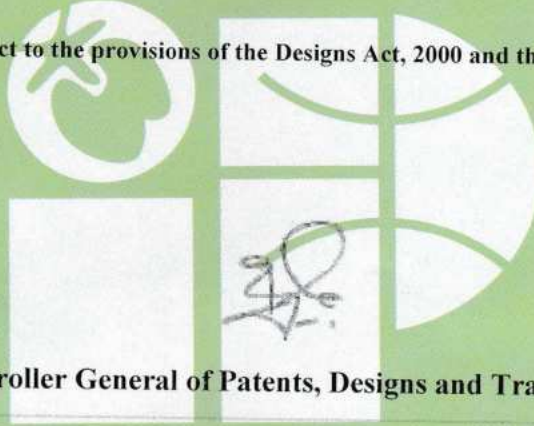

Controller General of Patents, Designs and Trade Marks

*The reciprocity date (if any) which has been allowed and the name of the country.

Copyright in the design will subsist for ten years from the date of Registration, and may under the terms of the Act and Rules, be extended for a further period of five years.

This Certificate is not for use in legal proceedings or for obtaining registration abroad

MS. DHARTI SHAH,
VERITE ASSOCIATES, 105, SCARLET GATEWAY, NR.
SPIPA ACADEMY, CORPORATE ROAD,
PRAHALADNAGR, AHMEDABAD-380015, GUJARAT,
INDIA

INTELLECTUAL
PROPERTY INDIA
PATENTS | DESIGNS | TRADE MARKS
GEOGRAPHICAL INDICATIONS

Date of Issue 16/12/2021 11:37:46

(REPRESENTATION SHEETS)

NAME OF THE APPLICANT
RIPEN SHAH
MIT SHAH

NO. OF SHEETS - 3
SHEET NO. - 1

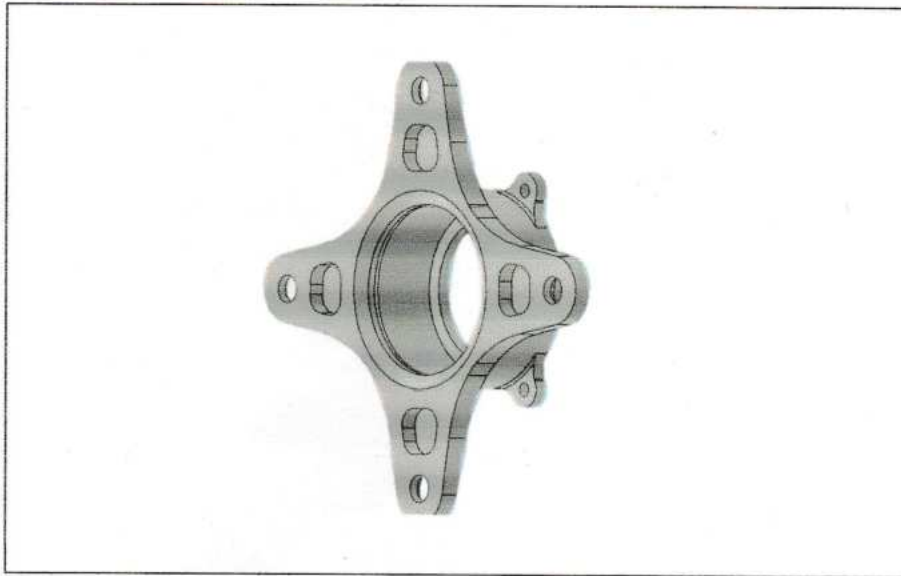

PERSPECTIVE VIEW

The novelty resides in the shape and configuration of the 'FRONT HUB' as illustrated.

~~A Front Wheel Hub is used for all-terrain vehicle with lighter material to improve its performance.~~

No claim is made by virtue of this registration in respect of any mechanical or other action of the mechanism whatever or in respect of any mode or principle of construction of the article.

No claim is made by virtue of the registration to any right to the exclusive use of the words, letters, numbers, colour, combination or Trade Marks as appearing in the representation.

350652-001

04 OCT 2021

Ms. DHARTI SHAH
(Authorized Agent of the Applicant)
(IN/PA- 2590)

(REPRESENTATION SHEETS)

NAME OF THE APPLICANT
RIPEN SHAH
MIT SHAH

NO. OF SHEETS - 3
SHEET NO. - 2



FRONT VIEW



TOP VIEW

The novelty resides in the shape and configuration of the 'FRONT HUB' as illustrated.

A Front Wheel Hub is used for all-terrain vehicle with lighter material to improve its performance.

No claim is made by virtue of this registration in respect of any mechanical or other action of the mechanism whatever or in respect of any mode or principle of construction of the article.

No claim is made by virtue of the registration to any right to the exclusive use of the words, letters, numbers, colour, combination or Trade Marks as appearing in the representation.

350652-001

04 OCT 2021



Ms. DHARTI SHAH
(Authorized Agent of the Applicant)
(IN/PA- 2590)

(REPRESENTATION SHEETS)

NAME OF THE APPLICANT
RIPEN SHAH
MIT SHAH

NO. OF SHEETS - 3
SHEET NO. - 3



BOTTOM VIEW

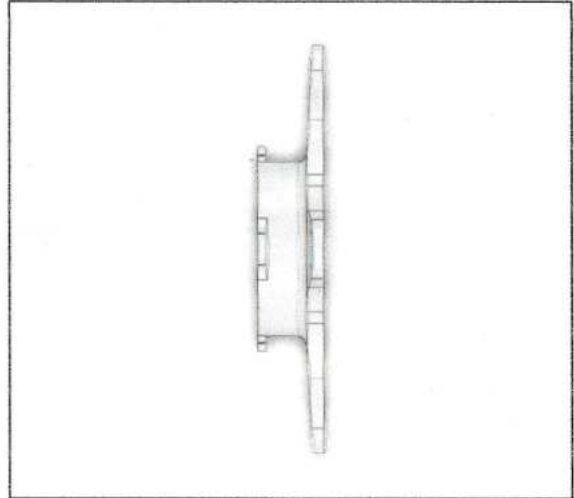

LEFT SIDE VIEW

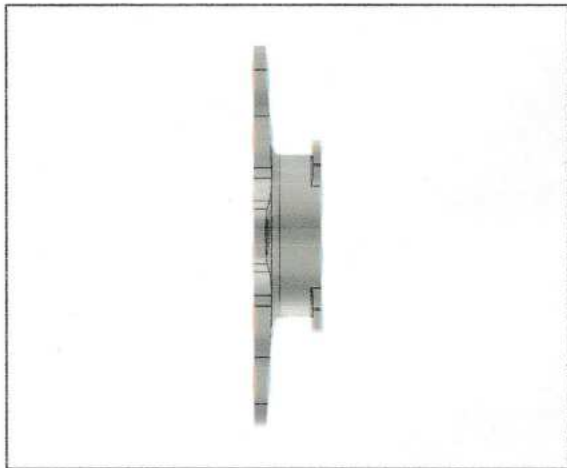

RIGHT SIDE VIEW

The novelty resides in the shape and configuration of the 'FRONT HUB' as illustrated.

A Front Wheel Hub is used for all-terrain vehicle with lighter material to improve its performance.



No claim is made by virtue of this registration in respect of any mechanical or other action of the mechanism whatever or in respect of any mode or principle of construction of the article.

No claim is made by virtue of the registration to any right to the exclusive use of the words, letters, numbers, colour, combination or Trade Marks as appearing in the representation.

350652-001

04 OCT 2021

Ms. DHARTI SHAH
(Authorized Agent of the Applicant)
(IN/PA- 2590)

DESIGN NUMBER	350648-001	
CLASS	12-16	
1.VIRAT DHOLAKIYA, SILVER OAK UNIVERSITY CAMPUS, OPP. BHAGWAT VIDYAPITH, S.G ROAD, GOTA, AHMEDABAD – 382421, INDIA 2. YASH MOHNOT, SILVER OAK UNIVERSITY CAMPUS, OPP. BHAGWAT VIDYAPITH, S.G ROAD, GOTA, AHMEDABAD – 382421, INDIA		
DATE OF REGISTRATION	04/10/2021	
TITLE	ROLLCAGE STRUCTURE	
PRIORITY NA		
DESIGN NUMBER	350652-001	
CLASS	12-16	
1.RIPEN SHAH, SILVER OAK UNIVERSITY CAMPUS, OPP. BHAGWAT VIDYAPITH, S.G ROAD, GOTA, AHMEDABAD – 382421 2. MIT SHAH, SILVER OAK UNIVERSITY CAMPUS, OPP. BHAGWAT VIDYAPITH, S.G ROAD, GOTA, AHMEDABAD – 382421		
DATE OF REGISTRATION	04/10/2021	
TITLE	FRONT HUB	
PRIORITY NA		
DESIGN NUMBER	350729-001	
CLASS	24-02	
1.DR. BANDANA MAHAPATRA, ASSISTANT PROFESSOR, DEPARTMENT: SCHOOL OF DATA SCIENCE, SYMBIOSIS SKILLS AND PROFESSIONAL UNIVERSITY, VILLAGE - KIWALE, ADJOINING PUNE MUMBAI EXPRESSWAY, MAHARASHTRA, INDIA, PINCODE: 412101 2. DR. ANAND NAYYAR, LECTURER, RESEARCHER AND SCIENTIST, GRADUATE SCHOOL, DUY TAN UNIVERSITY, 254 NGUYEN VAN LINH STREET, GRADUATE SCHOOL, DA NANG 550000, VIET NAM 3. KUMARSANJAY K. BHOREKAR, ASSISTANT PROFESSOR, DEPARTMENT NAME: SCHOOL OF DATA SCIENCE & CSIT, SYMBIOSIS SKILLS AND PROFESSIONAL UNIVERSITY, VILLAGE - KIWALE, ADJOINING PUNE MUMBAI EXPRESSWAY, MAHARASHTRA, INDIA, PINCODE: 412101 4. DR. RUBY JAIN, ASSISTANT PROFESSOR, SCHOOL OF DATA SCIENCE, SYMBIOSIS SKILLS AND PROFESSIONAL UNIVERSITY, ADJOINING MUMBAI PUNE EXPRESSWAY KIWALE PUNE MAHARASHTRA INDIA 412101		
DATE OF REGISTRATION	05/10/2021	
TITLE	ANTI-THEFT DRUG SECURITY DEVICE	
PRIORITY NA		



सत्यमेव जयते

भारत सरकार
GOVERNMENT OF INDIA
पेटेंट कार्यालय
THE PATENT OFFICE

ORIGINAL

No. 105848

CERTIFICATE OF REGISTRATION OF DESIGN

Design No. 350657-001
Date 04/10/2021 19:51:10
Reciprocity Date*
Country

Certified that the design of which a copy is annexed hereto has been registered as of the number and date given above in class 12-16 in respect of the application of such design to REAR WHEEL KNUCKLE in the name of I.NIHAR RAVAL, SILVER OAK UNIVERSITY CAMPUS, OPP. BHAGWAT VIDYAPITH, S.G ROAD, GOTA, AHMEDABAD – 382421, INDIA 2. NEJAL PATEL, SILVER OAK UNIVERSITY CAMPUS, OPP. BHAGWAT VIDYAPITH, S.G ROAD, GOTA, AHMEDABAD – 382421, INDIA

in pursuance of and subject to the provisions of the Designs Act, 2000 and the Designs Rules, 2001.

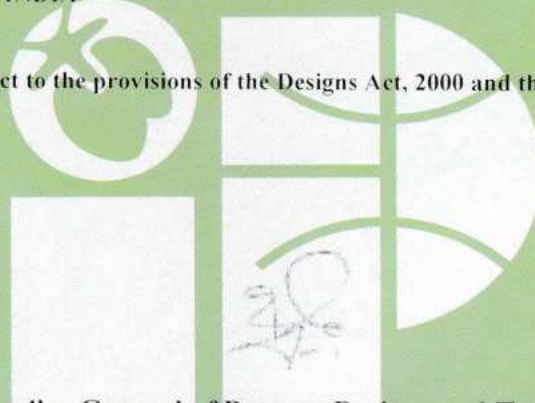

Controller General of Patents, Designs and Trade Marks

*The reciprocity date (if any) which has been allowed and the name of the country.

Copyright in the design will subsist for ten years from the date of Registration, and may under the terms of the Act and Rules, be extended for a further period of five years.

This Certificate is not for use in legal proceedings or for obtaining registration abroad

MS. DHARTI SHAH,
VERITE ASSOCIATES, 105, SCARLET GATEWAY, NR.
SPIPA ACADEMY, CORPORATE ROAD,
PRAHALADNAGR, AHMEDABAD-380015, GUJARAT,
INDIA

INTELLECTUAL
PROPERTY INDIA
PATENTS | DESIGNS | TRADE MARKS
GEOGRAPHICAL INDICATIONS

Date of Issue 13/12/2021 11:13:45

(REPRESENTATION SHEETS)

NAME OF THE APPLICANT
NIHAR RAVAL
NEJAL PATEL

NO. OF SHEETS - 3
SHEET NO. - 1

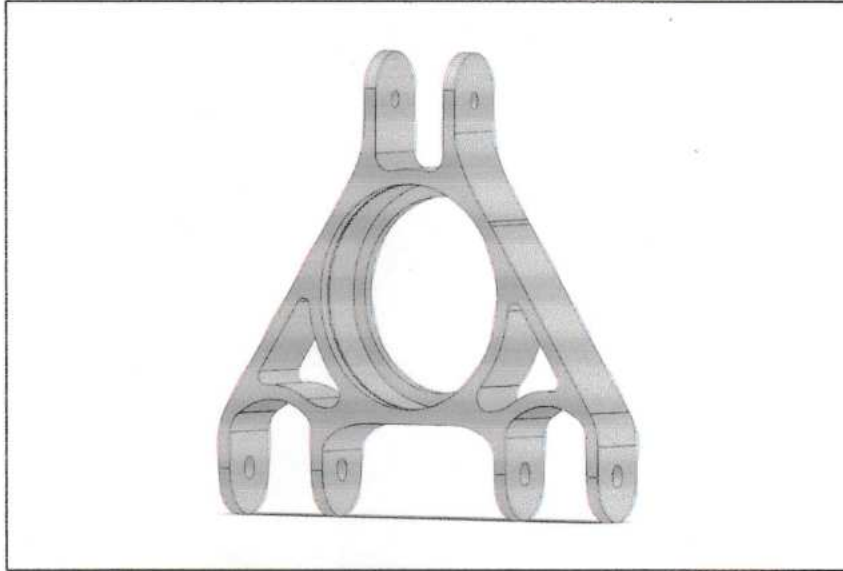

PERSPECTIVE VIEW

The novelty resides in the shape and configuration of the 'REAR WHEEL KNUCKLE' as illustrated.

A Rear Wheel Knuckle is used in all-terrain vehicle to control suspension and steering with lighter material to improve its performance.

No claim is made by virtue of this registration in respect of any mechanical or other action of the mechanism whatever or in respect of any mode or principle of construction of the article.

No claim is made by virtue of the registration to any right to the exclusive use of the words, letters, numbers, colour, combination or Trade Marks as appearing in the representation.

350657-001

04 OCT 2021

MS. DHARTI SHAH
(Authorized Agent of the Applicant)
(IN/PA- 2590)

(REPRESENTATION SHEETS)

NAME OF THE APPLICANT
NIHAR RAVAL
NEJAL PATEL

NO. OF SHEETS - 3
SHEET NO. - 2

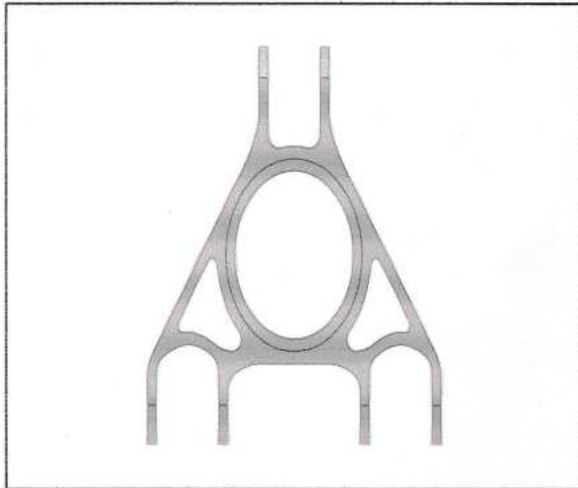

FRONT VIEW

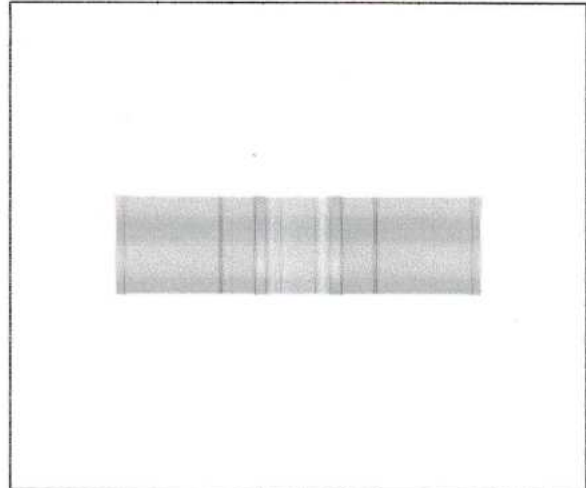

TOP VIEW

The novelty resides in the shape and configuration of the 'REAR WHEEL KNUCKLE' as illustrated.

~~A Rear Wheel Knuckle is used in all-terrain vehicle to control suspension and steering with lighter material to improve its performance.~~

No claim is made by virtue of this registration in respect of any mechanical or other action of the mechanism whatever or in respect of any mode or principle of construction of the article.

No claim is made by virtue of the registration to any right to the exclusive use of the words, letters, numbers, colour, combination or Trade Marks as appearing in the representation.

350657-001

04 OCT 2021

Ms. DHARTI SHAH
(Authorized Agent of the Applicant)
(IN/PA- 2590)

(REPRESENTATION SHEETS)

NAME OF THE APPLICANT
NIHAR RAVAL
NEJAL PATEL

NO. OF SHEETS - 3
SHEET NO. - 3

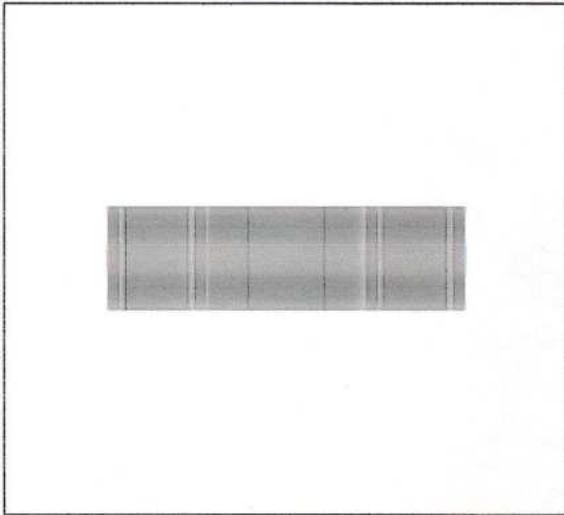

BOTTOM VIEW

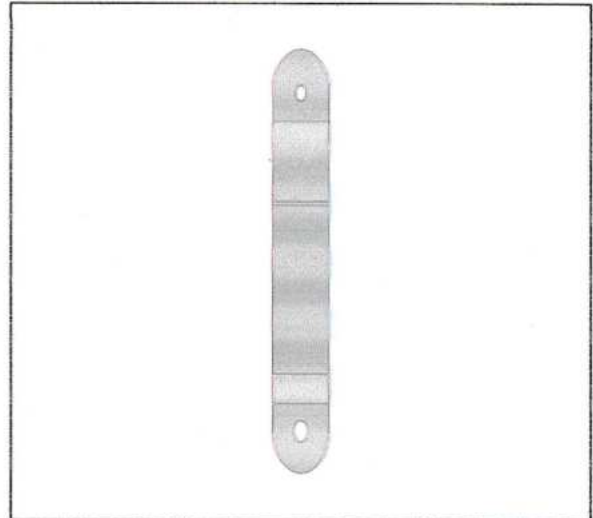

LEFT SIDE VIEW

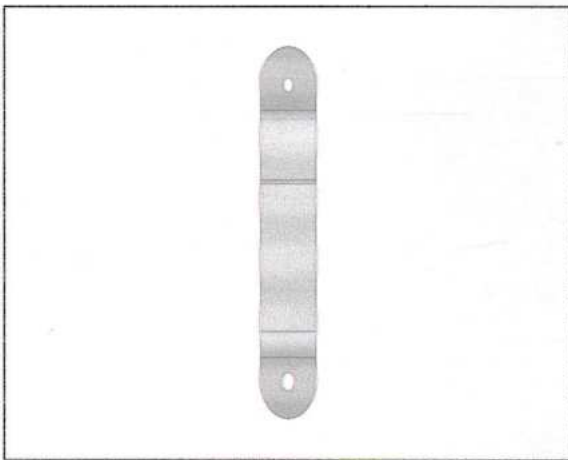

RIGHT SIDE VIEW

The novelty resides in the shape and configuration of the '**REAR WHEEL KNUCKLE**' as illustrated.

~~A Rear Wheel Knuckle is used in all-terrain vehicle to control suspension and steering with lighter material to improve its performance.~~



No claim is made by virtue of this registration in respect of any mechanical or other action of the mechanism whatever or in respect of any mode or principle of construction of the article.

No claim is made by virtue of the registration to any right to the exclusive use of the words, letters, numbers, colour, combination or Trade Marks as appearing in the representation.

350657-001

04 OCT 2021

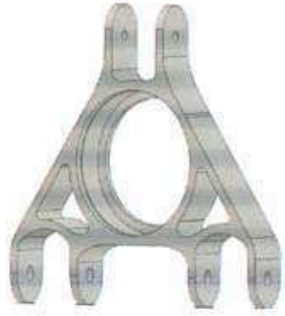
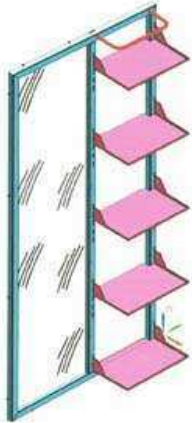
Ms. DHARTI SHAH
(Authorized Agent of the Applicant)
(IN/PA- 2590)

DESIGN NUMBER	350657-001	
CLASS	12-16	
1.NIHAR RAVAL, SILVER OAK UNIVERSITY CAMPUS, OPP. BHAGWAT VIDYAPITH, S.G ROAD, GOTA, AHMEDABAD – 382421, INDIA 2. NEJAL PATEL, SILVER OAK UNIVERSITY CAMPUS, OPP. BHAGWAT VIDYAPITH, S.G ROAD, GOTA, AHMEDABAD – 382421, INDIA		
DATE OF REGISTRATION	04/10/2021	
TITLE	REAR WHEEL KNUCKLE	
PRIORITY NA		
DESIGN NUMBER	350665-001	
CLASS	06-04	
SHASHIKANT DEVIDAS GOFANE, RAMABAI AMBEDKAR NAGAR, NEW NAGPUR – MUMBAI SAMRUDHI HIGHWAY, NEAR A.S CLUB, TISGAON, TA. DIST AURANGABAD, MAHARASHTRA 431136		
DATE OF REGISTRATION	04/10/2021	
TITLE	DRESSING RACK	
PRIORITY NA		
DESIGN NUMBER	350669-001	
CLASS	12-11	
SACHIN ANANT JADHAV, A-5 ECHINUS COURT, NEAR MITCON INSTITUTE , OPP BALEWADI STADIUM, BALEWADI, PUNE, MAHARASHTRA - 411045		
DATE OF REGISTRATION	05/10/2021	
TITLE	ELECTRIC SMART BIKE	
PRIORITY NA		



सत्यमेव जयते

भारत सरकार
GOVERNMENT OF INDIA
पेटेंट कार्यालय
THE PATENT OFFICE

ORIGINAL

No. 106648

CERTIFICATE OF REGISTRATION OF DESIGN

Design No. 350658-001
Date 04/10/2021 19:51:10
Reciprocity Date*
Country

Certified that the design of which a copy is annexed hereto has been registered as of the number and date given above in class 12-16 in respect of the application of such design to ROLL CAGE STRUCTURE in the name of LASHISH BIST, SILVER OAK UNIVERSITY CAMPUS, OPP. BHAGWAT VIDYAPITH, S.G ROAD, GOTA, AHMEDABAD – 382421, INDIA 2. NEJAL PATEL SILVER OAK UNIVERSITY CAMPUS, OPP. BHAGWAT VIDYAPITH, S.G ROAD, GOTA, AHMEDABAD – 382421, INDIA

in pursuance of and subject to the provisions of the Designs Act, 2000 and the Designs Rules, 2001.

Controller General of Patents, Designs and Trade Marks

*The reciprocity date (if any) which has been allowed and the name of the country.

Copyright in the design will subsist for ten years from the date of Registration, and may under the terms of the Act and Rules, be extended for a further period of five years.

This Certificate is not for use in legal proceedings or for obtaining registration abroad

MS. DHARTI SHAH,
VERITE ASSOCIATES, 105, SCARLET GATEWAY, NR.
SPIPA ACADEMY, CORPORATE ROAD,
PRAHALADNAGR, AHMEDABAD-380015, GUJARAT,
INDIA

Date of Issue 28/12/2021 15:42:44

NAME OF THE APPLICANT
ASHISH BIST
NEJAL PATEL

NO. OF SHEETS - 3
SHEET NO. - 1

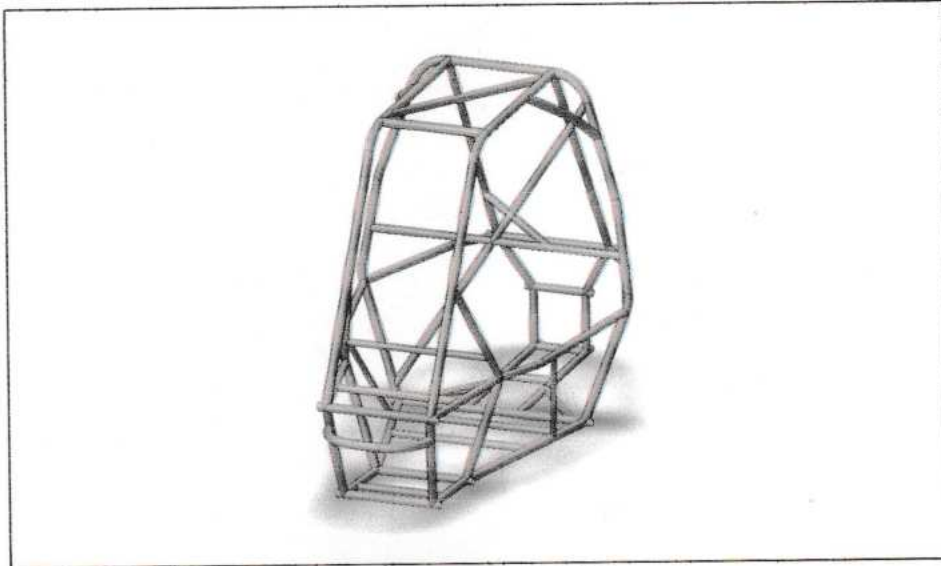

PERSPECTIVE VIEW

The novelty resides in the shape and configuration of the '**ROLLCAGE STRUCTURE**' as illustrated.

~~A Rollcage Structure is specially designed chassis for all-terrain vehicle to make the structure safe and light in weight.~~

No claim is made by virtue of this registration in respect of any mechanical or other action of the mechanism whatever or in respect of any mode or principle of construction of the article.

No claim is made by virtue of the registration to any right to the exclusive use of the words, letters, numbers, colour, combination or Trade Marks as appearing in the representation.

350658-001

04 OCT 2021

Ms. DHARTI SHAH
(Authorized Agent of the Applicant)
(IN/PA- 2590)

(REPRESENTATION SHEETS)

NAME OF THE APPLICANT
ASHISH BIST
NEJAL PATEL

NO. OF SHEETS - 3
SHEET NO. - 2

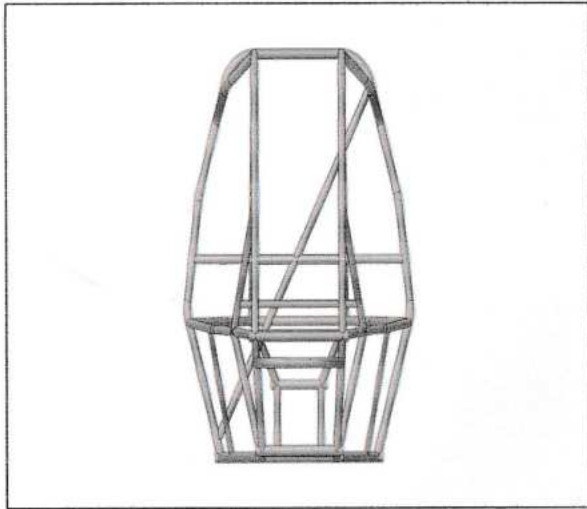

FRONT VIEW

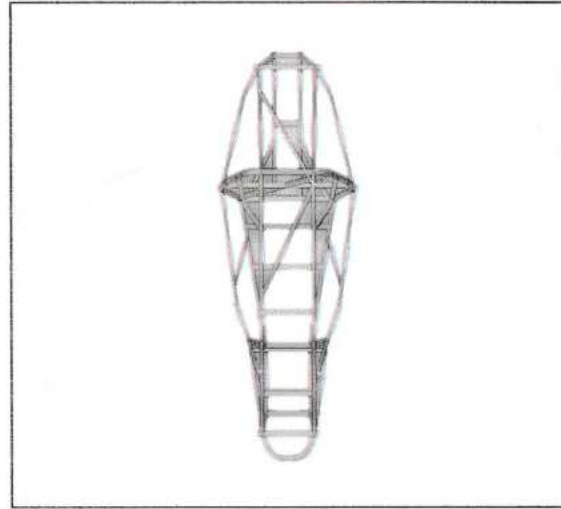

TOP VIEW

The novelty resides in the shape and configuration of the '**ROLLCAGE STRUCTURE**' as illustrated.

A Rollcage Structure is specially designed chassis for all-terrain vehicle to make the structure safe and light in weight.

No claim is made by virtue of this registration in respect of any mechanical or other action of the mechanism whatever or in respect of any mode or principle of construction of the article.

No claim is made by virtue of the registration to any right to the exclusive use of the words, letters, numbers, colour, combination or Trade Marks as appearing in the representation.

350658-001

04 OCT 2021

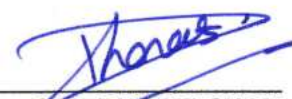
Ms. DHARTI SHAH
(Authorized Agent of the Applicant)
(IN/PA- 2590)

(REPRESENTATION SHEETS)

NAME OF THE APPLICANT
ASHISH BIST
NEJAL PATEL

NO. OF SHEETS - 3
SHEET NO. - 3

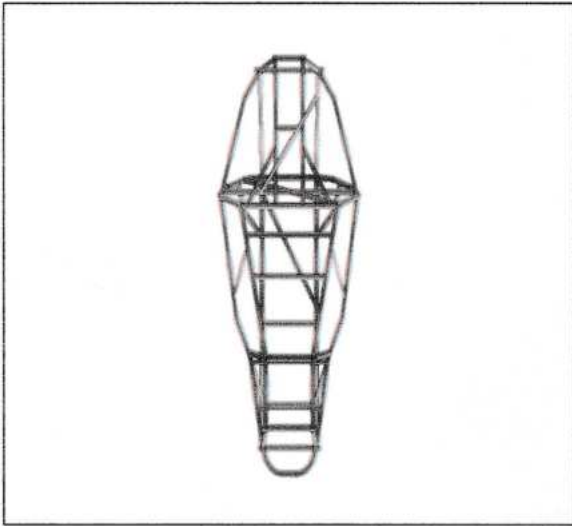

BOTTOM VIEW

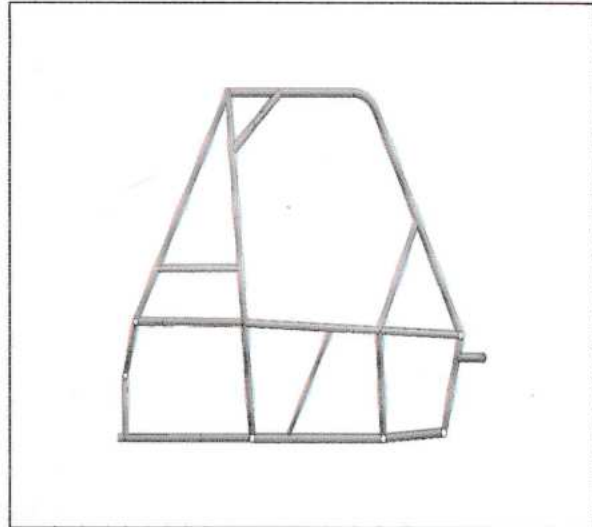

LEFT SIDE VIEW

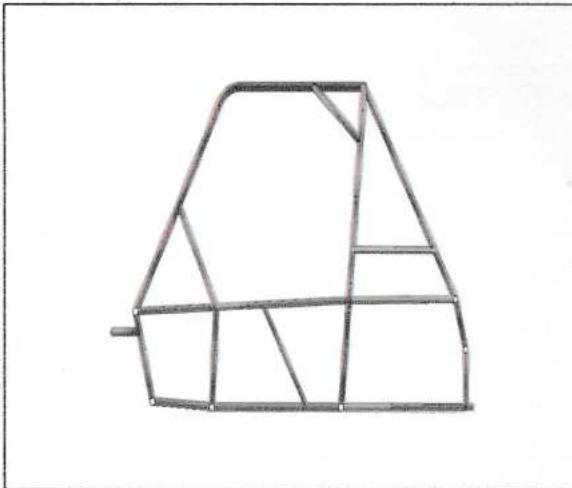

RIGHT SIDE VIEW

The novelty resides in the shape and configuration of the '**ROLLCAGE STRUCTURE**' as illustrated.

~~A Rollcage Structure is specially designed chassis for all-terrain vehicle to make the structure safe and light in weight.~~



No claim is made by virtue of this registration in respect of any mechanical or other action of the mechanism whatever or in respect of any mode or principle of construction of the article.

No claim is made by virtue of the registration to any right to the exclusive use of the words, letters, numbers, colour, combination or Trade Marks as appearing in the representation.

350658 - 001

04 OCT 2021

MS. DHARTI SHAH
(Authorized Agent of the Applicant)
(IN/PA- 2590)

DESIGN NUMBER	350658-001		
CLASS	12-16		
1. ASHISH BIST, SILVER OAK UNIVERSITY CAMPUS, OPP. BHAGWAT VIDYAPITH, S.G ROAD, GOTA, AHMEDABAD – 382421, INDIA 2. NEJAL PATEL SILVER OAK UNIVERSITY CAMPUS, OPP. BHAGWAT VIDYAPITH, S.G ROAD, GOTA, AHMEDABAD – 382421, INDIA			
DATE OF REGISTRATION	04/10/2021		
TITLE	ROLLCAGE STRUCTURE		
PRIORITY NA			
DESIGN NUMBER	309644		
CLASS	14-03		
HUAWEI TECHNOLOGIES CO., LTD., HUAWEI ADMINISTRATION BUILDING, BANTIAN, LONGGANG DISTRICT, SHENZHEN, GUANGDONG 518129, PEOPLE'S REPUBLIC OF CHINA			
DATE OF REGISTRATION	07/09/2018		
TITLE	MOBILE PHONE		
PRIORITY			
PRIORITY NUMBER	DATE	COUNTRY	
201830087156.7	09/03/2018	CHINA	
DESIGN NUMBER	314611-001		
CLASS	09-01		
HERMES DISTILLERY PRIVATE LIMITED, YADRAV, TAL. RAIBAG, DIST. BELAGAVI, KARNATAKA- 591 317, INDIA			
DATE OF REGISTRATION	05/02/2019		
TITLE	BOTTLE		
PRIORITY NA			



सत्यमेव जयते

भारत सरकार
GOVERNMENT OF INDIA
पेटेंट कार्यालय
THE PATENT OFFICE

ORIGINAL

No. 105525

CERTIFICATE OF REGISTRATION OF DESIGN

Design No. 350659-001
Date 04/10/2021 19:51:10
Reciprocity Date*
Country

Certified that the design of which a copy is annexed hereto has been registered as of the number and date given above in class 12-16 in respect of the application of such design to STEERING WHEEL in the name of 1.VENISH SUTHAR, SILVER OAK UNIVERSITY CAMPUS, OPP. BHAGWAT VIDYAPITH, S.G ROAD, GOTA, AHMEDABAD – 382421 2. ISHAN THAKAR, SILVER OAK UNIVERSITY CAMPUS, OPP. BHAGWAT VIDYAPITH, S.G ROAD, GOTA, AHMEDABAD – 382421

in pursuance of and subject to the provisions of the Designs Act, 2000 and the Designs Rules, 2001.

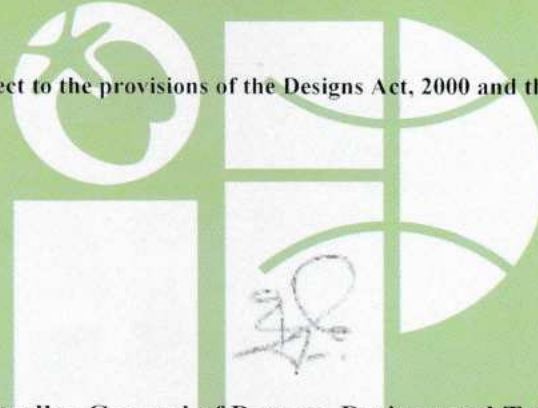

Controller General of Patents, Designs and Trade Marks

*The reciprocity date (if any) which has been allowed and the name of the country.

Copyright in the design will subsist for ten years from the date of Registration, and may under the terms of the Act and Rules, be extended for a further period of five years.

This Certificate is not for use in legal proceedings or for obtaining registration abroad

MS. DHARTI SHAH,
VERITE ASSOCIATES, 105, SCARLET GATEWAY, NR.
SIIPA ACADEMY, CORPORATE ROAD,
PRAHALADNAGR, AHMEDABAD-380015, GUJARAT,
INDIA

INTELLECTUAL
PROPERTY INDIA
PATENTS | DESIGNS | TRADE MARKS
GEOGRAPHICAL INDICATIONS

Date of Issue 03/12/2021 11:43:05

(REPRESENTATION SHEETS)

NAME OF THE APPLICANT
VENISH SUTHAR
ISHAN THAKAR

NO. OF SHEETS - 3
SHEET NO. - 1

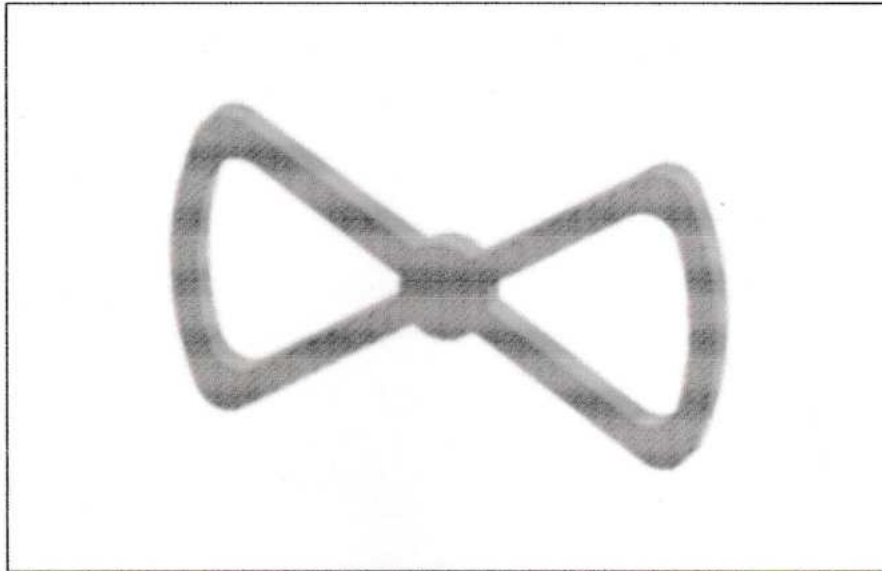

PERSPECTIVE VIEW

The novelty resides in the shape and configuration of the '**STEERING WHEEL**' as illustrated.

~~A Steering Wheel is specially designed with high strength and lighter weight material for all-terrain vehicle.~~

No claim is made by virtue of this registration in respect of any mechanical or other action of the mechanism whatever or in respect of any mode or principle of construction of the article.

No claim is made by virtue of the registration to any right to the exclusive use of the words, letters, numbers, colour, combination or Trade Marks as appearing in the representation.

350659-001
04 OCT 2021

Ms. DHARTI SHAH
(Authorized Agent of the Applicant)
(IN/PA- 2590)

(REPRESENTATION SHEETS)

NAME OF THE APPLICANT
VENISH SUTHAR
ISHAN THAKAR

NO. OF SHEETS - 3
SHEET NO. - 2

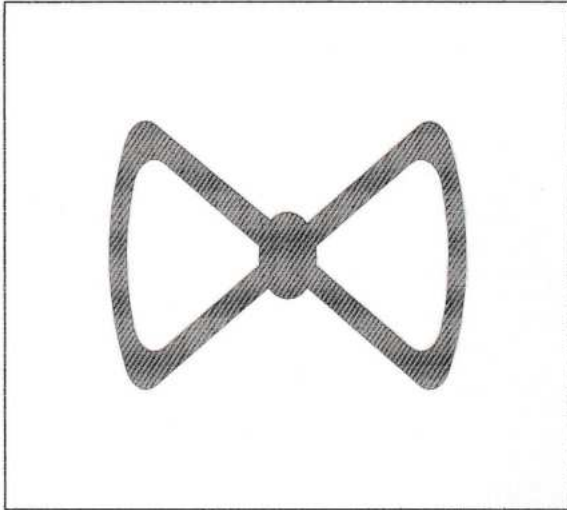

FRONT VIEW



TOP VIEW

The novelty resides in the shape and configuration of the 'STEERING WHEEL' as illustrated.

~~A Steering Wheel is specially designed with high strength and lighter weight material for all-terrain vehicle.~~

No claim is made by virtue of this registration in respect of any mechanical or other action of the mechanism whatever or in respect of any mode or principle of construction of the article.

No claim is made by virtue of the registration to any right to the exclusive use of the words, letters, numbers, colour, combination or Trade Marks as appearing in the representation.

350659-001
04 OCT 2021

Ms. DHARTI SHAH
(Authorized Agent of the Applicant)
(IN/PA- 2590)

(REPRESENTATION SHEETS)

NAME OF THE APPLICANT
VENISH SUTHAR
ISHAN THAKAR

NO. OF SHEETS - 3
SHEET NO. - 3

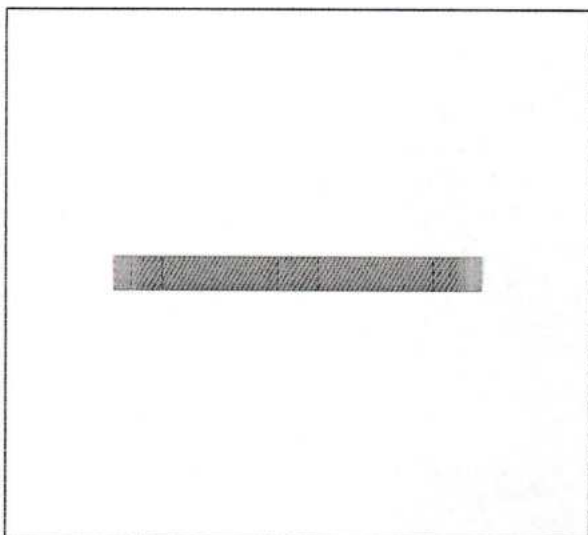

BOTTOM VIEW

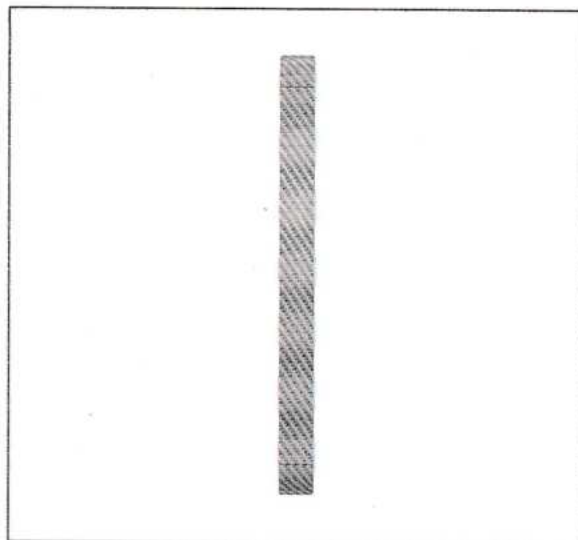

LEFT SIDE VIEW

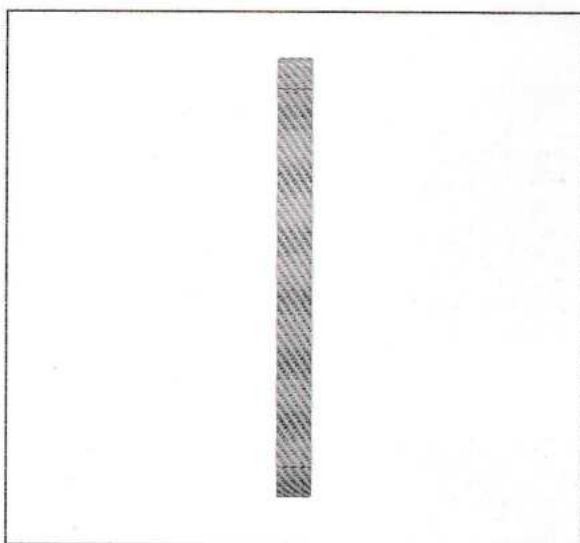

RIGHT SIDE VIEW

The novelty resides in the shape and configuration of the 'STEERING WHEEL' as illustrated.

~~A Steering Wheel is specially designed with high strength and lighter weight material for all-terrain vehicle.~~



No claim is made by virtue of this registration in respect of any mechanical or other action of the mechanism whatever or in respect of any mode or principle of construction of the article.

No claim is made by virtue of the registration to any right to the exclusive use of the words, letters, numbers, colour, combination or Trade Marks as appearing in the representation.

350659-001

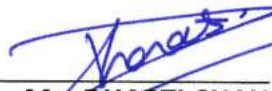
04 OCT 2021

Ms. DHARTI SHAH
(Authorized Agent of the Applicant)
(IN/PA- 2590)

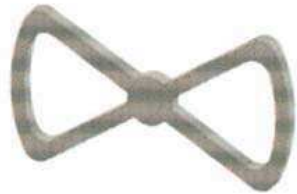
DESIGN NUMBER	350636-001	
CLASS	02-02	
ASHISH DHIRUBHAI SORTHIYA, FANTASY FAB, 2ND FLOOR, 2001, SHREE KUBERJI TEXTILE WORLD, SAROLI, SURAT-395010, GUJARAT		
DATE OF REGISTRATION	04/10/2021	
TITLE	LADIES GARMENT (KURTI)	
PRIORITY NA		
DESIGN NUMBER	350651-001	
CLASS	12-16	
1.HIMANSHU VAGHELA, SILVER OAK UNIVERSITY CAMPUS, OPP. BHAGWAT VIDYAPITH, S.G ROAD, GOTA, AHMEDABAD – 382421 2. ISHAN THAKAR, SILVER OAK UNIVERSITY CAMPUS, OPP. BHAGWAT VIDYAPITH, S.G ROAD, GOTA, AHMEDABAD – 382421		
DATE OF REGISTRATION	04/10/2021	
TITLE	FRONT DISC BRAKE	
PRIORITY NA		
DESIGN NUMBER	350659-001	
CLASS	12-16	
1.VENISH SUTHAR, SILVER OAK UNIVERSITY CAMPUS, OPP. BHAGWAT VIDYAPITH, S.G ROAD, GOTA, AHMEDABAD – 382421 2. ISHAN THAKAR, SILVER OAK UNIVERSITY CAMPUS, OPP. BHAGWAT VIDYAPITH, S.G ROAD, GOTA, AHMEDABAD – 382421		
DATE OF REGISTRATION	04/10/2021	
TITLE	STEERING WHEEL	
PRIORITY NA		



ORIGINAL

No. 108513

भारत सरकार
GOVERNMENT OF INDIA
पेटेंट कार्यालय
THE PATENT OFFICE

CERTIFICATE OF REGISTRATION OF DESIGN

Design No. 353752-001
Date 26/11/2021 16:11:15
Reciprocity Date*
Country

Certified that the design of which a copy is annexed hereto has been registered as of the number and date given above in class 12-16 in respect of the application of such design to GEAR BOX FOR CONSTRAINED GEAR TRAIN OF PORTAL AXLE SYSTEM in the name of 1.DHRUVIN PATEL, SILVER OAK UNIVERSITY CAMPUS, OPP. BHAGWAT VIDYAPITH, S.G ROAD, GOTA, AHMEDABAD – 382481, INDIA 2. DEVANSH SHAH, SILVER OAK UNIVERSITY CAMPUS, OPP. BHAGWAT VIDYAPITH, S.G ROAD, GOTA, AHMEDABAD – 382481, INDIA 3. RUSHIL SHAH, SILVER OAK UNIVERSITY CAMPUS, OPP. BHAGWAT VIDYAPITH, S.G ROAD, GOTA, AHMEDABAD – 382481, INDIA

in pursuance of and subject to the provisions of the Designs Act, 2000 and the Designs Rules, 2001.

Controller General of Patents, Designs and Trade Marks

*The reciprocity date (if any) which has been allowed and the name of the country.

Copyright in the design will subsist for ten years from the date of Registration, and may under the terms of the Act and Rules, be extended for a further period of five years.

This Certificate is not for use in legal proceedings or for obtaining registration abroad

MS. DHARTI SHAH,
VERITE ASSOCIATES, 105, SCARLET GATEWAY, NR.
SPIPA ACADEMY, CORPORATE ROAD,
PRAHALADNAGR, AHMEDABAD-380015, GUJARAT,
INDIA

Date of Issue 08/02/2022 15:28:22

(REPRESENTATION SHEETS)

NAME OF THE APPLICANT
DHRUVIN PATEL
DEVANSH SHAH
RUSHIL SHAH

NO. OF SHEETS - 3
SHEET NO. - 1

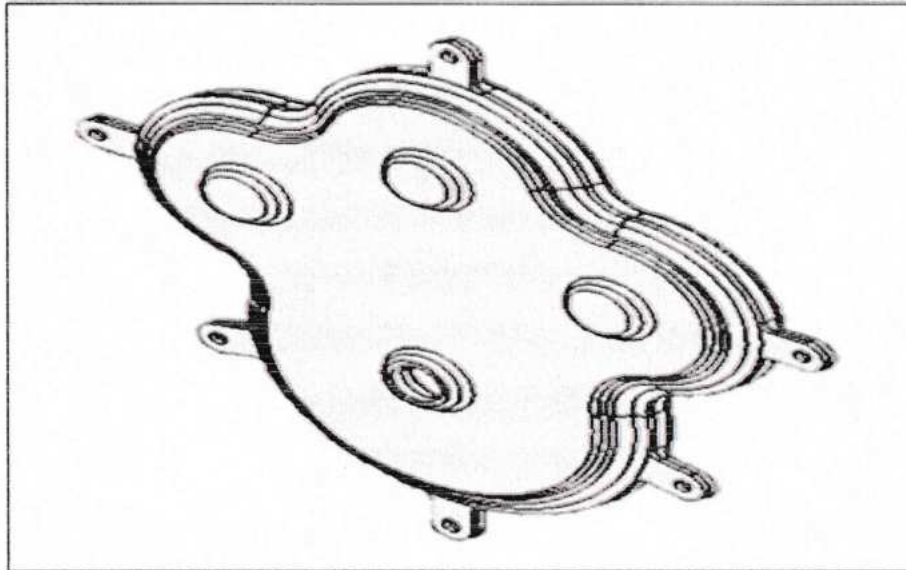

PERSPECTIVE VIEW

The novelty resides in the shape and configuration of the 'GEAR BOX FOR CONSTRAINED GEAR TRAIN OF PORTAL AXLE SYSTEM' as illustrated.

No claim is made by virtue of this registration in respect of any mechanical or other action of the mechanism whatever or in respect of any mode or principle of construction of the article.

No claim is made by virtue of the registration to any right to the exclusive use of the words, letters, numbers, colour, combination or Trade Marks as appearing in the representation.

353752-601
26 NOV 2021

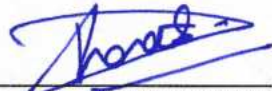
Ms. DHARTI SHAH
(Authorized Agent of the Applicant)
(IN/PA- 2590)

(REPRESENTATION SHEETS)

NAME OF THE APPLICANT
DHRUVIN PATEL
DEVANSH SHAH
RUSHIL SHAH

NO. OF SHEETS - 3
SHEET NO. - 2

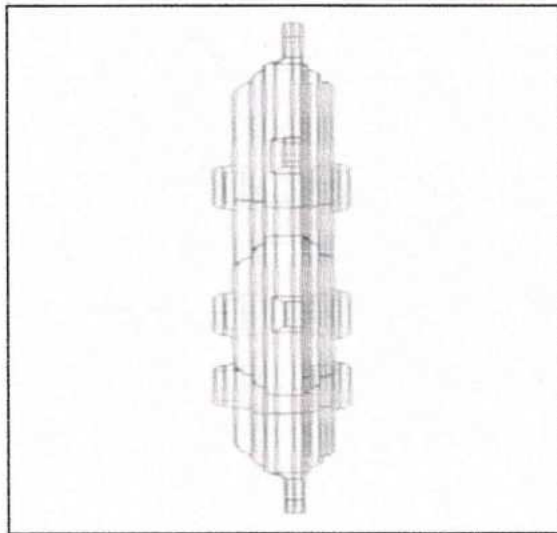

SIDE VIEW

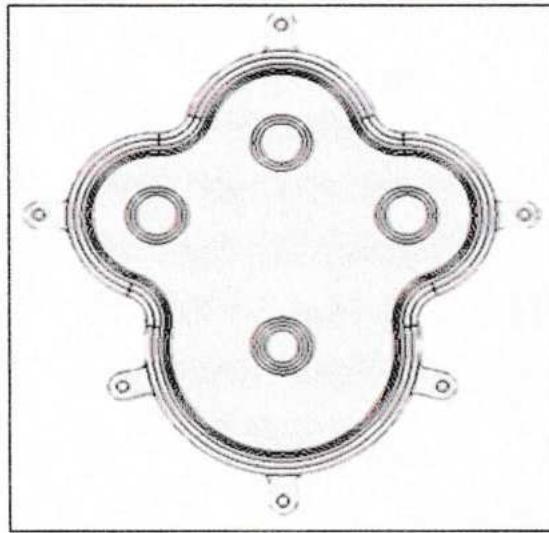

FRONT VIEW

The novelty resides in the shape and configuration of the '**GEAR BOX FOR CONSTRAINED GEAR TRAIN OF PORTAL AXLE SYSTEM**' as illustrated.

No claim is made by virtue of this registration in respect of any mechanical or other action of the mechanism whatever or in respect of any mode or principle of construction of the article.

No claim is made by virtue of the registration to any right to the exclusive use of the words, letters, numbers, colour, combination or Trade Marks as appearing in the representation.

353752-001

26 NOV 2021

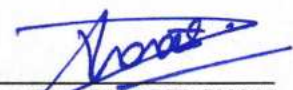

Ms. DHARTI SHAH
(Authorized Agent of the Applicant)
(IN/PA- 2590)

(REPRESENTATION SHEETS)

NAME OF THE APPLICANT
DHRUVIN PATEL
DEVANSH SHAH
RUSHIL SHAH

NO. OF SHEETS - 3
SHEET NO. - 3

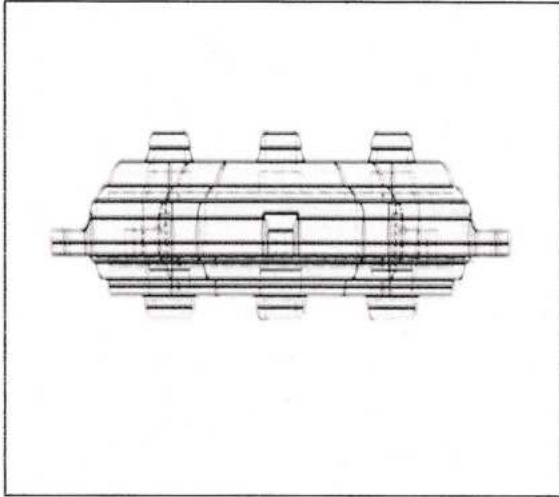

TOP VIEW

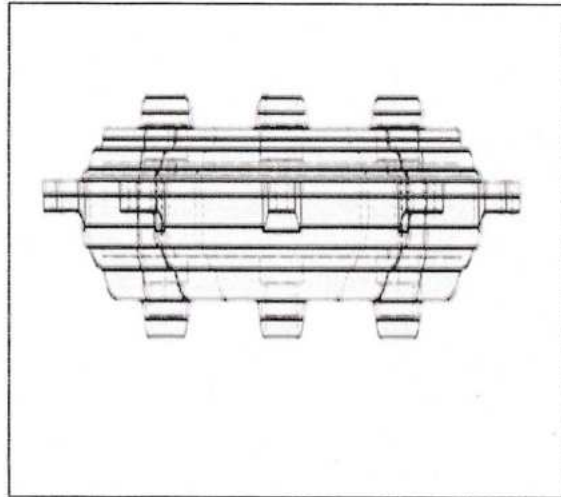

BOTTOM VIEW

The novelty resides in the shape and configuration of the 'GEAR BOX FOR CONSTRAINED GEAR TRAIN OF PORTAL AXLE SYSTEM' as illustrated.

No claim is made by virtue of this registration in respect of any mechanical or other action of the mechanism whatever or in respect of any mode or principle of construction of the article.

No claim is made by virtue of the registration to any right to the exclusive use of the words, letters, numbers, colour, combination or Trade Marks as appearing in the representation.

Ms. DHARTI SHAH
(Authorized Agent of the Applicant)
(IN/PA- 2590)

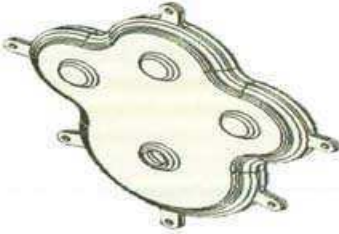
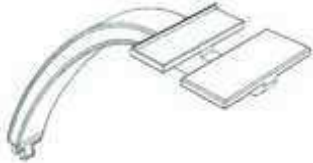
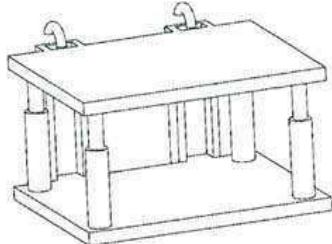
DESIGN NUMBER	353752-001	
CLASS	12-16	
1.DHRUVIN PATEL, SILVER OAK UNIVERSITY CAMPUS, OPP. BHAGWAT VIDYAPITH, S.G ROAD, GOTA, AHMEDABAD – 382481, INDIA 2. DEVANSH SHAH, SILVER OAK UNIVERSITY CAMPUS, OPP. BHAGWAT VIDYAPITH, S.G ROAD, GOTA, AHMEDABAD – 382481, INDIA 3. RUSHIL SHAH, SILVER OAK UNIVERSITY CAMPUS, OPP. BHAGWAT VIDYAPITH, S.G ROAD, GOTA, AHMEDABAD – 382481, INDIA		
DATE OF REGISTRATION	26/11/2021	
TITLE	GEAR BOX FOR CONSTRAINED GEAR TRAIN OF PORTAL AXLE SYSTEM	
PRIORITY NA		
DESIGN NUMBER	355309-001	
CLASS	24-01	
1.RISHIRAJ COLLEGE OF DENTAL SCIENCES AND RESEARCH CENTRE, C/O LNCT GROUP OF COLLEGE, GANDHINAGAR, BHOPAL, 462036 M.P. INDIA 2. PROF. (DR.) PRASHANT JAJU, RISHIRAJ COLLEGE OF DENTAL SCIENCES AND RESEARCH CENTRE, GANDHINAGAR, BHOPAL, 462036 M.P. INDIA 3. PROF. (DR.) SUSHMA JAJU, RISHIRAJ COLLEGE OF DENTAL SCIENCES AND RESEARCH CENTRE, GANDHINAGAR, BHOPAL, 462036 M.P. INDIA 4. DR. ANURAG S.D. RAI, ASSO. PROF. DIRECTOR, KALCHURI LNCT INCUBATION CENTRE, LNCT, BHOPAL, 462022 M.P. INDIA , ET AL.		
DATE OF REGISTRATION	21/12/2021	
TITLE	REST HOLDER FOR ORAL SURGERY AND DENTAL IMPLANT MACHINE	
PRIORITY NA		
DESIGN NUMBER	355311-001	
CLASS	12-05	
1.PRAGYAN JAIN, DEAN R&D, ME DEPT., GGITS, JABALPUR, M.P. INDIA 2. TARA KANT, EXECUTIVE IPR, R&D DEPT., LNCT, BHOPAL, M.P. INDIA 3. VIKAS PANDEY, CO – FOUNDER, EDUGUIDE CONSULTNACY PVT. LTD., BHOPAL M.P. INDIA 4. DR. VIKAS PARE, PROFESSOR, ME DEPT., LNCT&S, BHOPAL, M.P. INDIA , ET AL.		
DATE OF REGISTRATION	21/12/2021	
TITLE	LIFTING DEVICE	
PRIORITY NA		



ORIGINAL

No. 108066

भारत सरकार
GOVERNMENT OF INDIA
पेटेंट कार्यालय
THE PATENT OFFICE

CERTIFICATE OF REGISTRATION OF DESIGN

Design No. 353737-001
Date 26/11/2021 16:11:15
Reciprocity Date*
Country

Certified that the design of which a copy is annexed hereto has been registered as of the number and date given above in class 15-05 in respect of the application of such design to BODY AND CLOTH DRYER in the name of 1.KEVAL BHAVSAR, SILVER OAK UNIVERSITY CAMPUS, OPP. BHAGWAT VIDYAPITH, S.G ROAD, GOTA, AHMEDABAD – 382481, INDIA 2. JAIMIN PANCHAL, SILVER OAK UNIVERSITY CAMPUS, OPP. BHAGWAT VIDYAPITH, S.G ROAD, GOTA, AHMEDABAD – 382481, INDIA 3. DHARMIK GOHEL, SILVER OAK UNIVERSITY CAMPUS, OPP. BHAGWAT VIDYAPITH, S.G ROAD, GOTA, AHMEDABAD – 382481, INDIA 4. JAY KHATRI, SILVER OAK UNIVERSITY CAMPUS, OPP. BHAGWAT VIDYAPITH, S.G ROAD, GOTA, AHMEDABAD – 382481, INDIA, ET AL.

in pursuance of and subject to the provisions of the Designs Act, 2000 and the Designs Rules, 2001.

Controller General of Patents, Designs and Trade Marks

*The reciprocity date (if any) which has been allowed and the name of the country.

Copyright in the design will subsist for ten years from the date of Registration, and may under the terms of the Act and Rules, be extended for a further period of five years.

This Certificate is not for use in legal proceedings or for obtaining registration abroad

MS.DHARTI SHAH,
VERITE ASSOCIATES, 105, SCARLET GATEWAY, NR.
SPIPA ACADEMY, CORPORATE ROAD,
PRAHALADNAGR, AHMEDABAD-380015, GUJARAT,
INDIA

Date of Issue 28/01/2022 16:53:13

(REPRESENTATION SHEETS)

NAME OF THE APPLICANT
KEVAL BHAVSAR
JAIMIN PANCHAI
DHARMIK GOHEL
JAY KHATRI
HITESH PRAJAPATI

NO. OF SHEETS - 3
SHEET NO. - 1

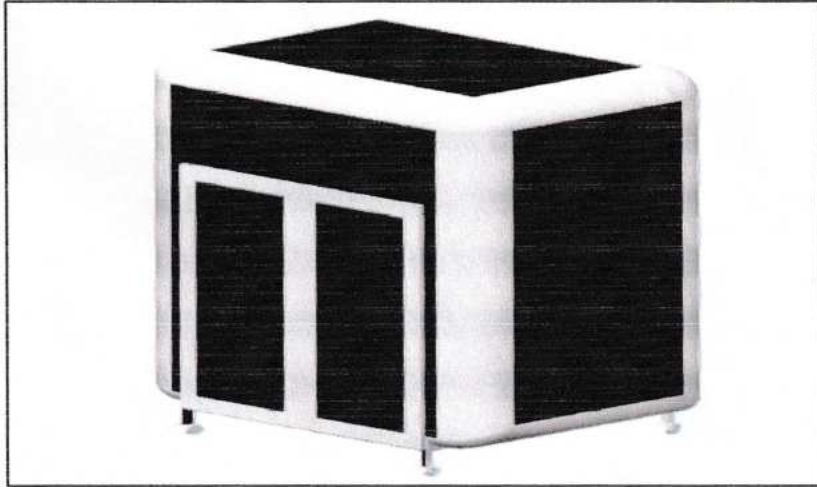

PERSPECTIVE VIEW

The novelty resides in the shape and configuration of the 'BODY AND CLOTH DRYER' as illustrated.

No claim is made by virtue of this registration in respect of any mechanical or other action of the mechanism whatever or in respect of any mode or principle of construction of the article.

No claim is made by virtue of the registration to any right to the exclusive use of the words, letters, numbers, colour, combination or Trade Marks as appearing in the representation.

Date: 26/11/2021

353737-001

26 NOV 2021

Ms. DHARTI SHAH
(Authorized Agent of the Applicant)
(IN/PA- 2590)

(REPRESENTATION SHEETS)

NAME OF THE APPLICANT
KEVAL BHAVSAR
JAIMIN PANCHAI
DHARMIK GOHEL
JAY KHATRI
HITESH PRAJAPATI

NO. OF SHEETS - 3
SHEET NO. - 2



FRONT VIEW

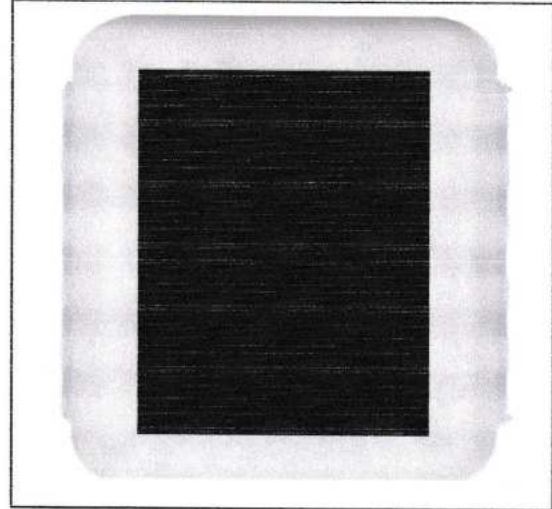

TOP VIEW

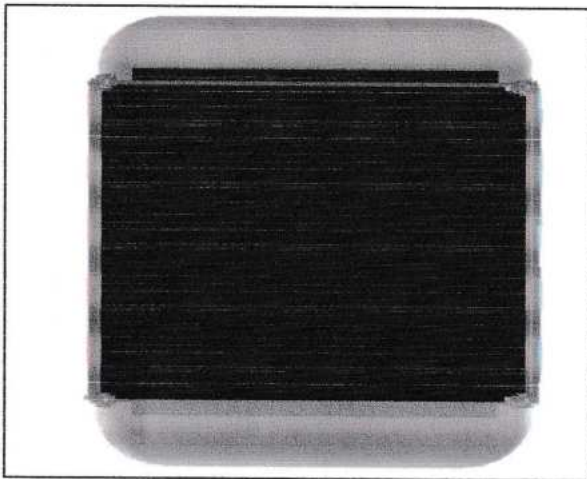

BOTTOM VIEW

The novelty resides in the shape and configuration of the 'BODY AND CLOTH DRYER' as illustrated.

No claim is made by virtue of this registration in respect of any mechanical or other action of the mechanism whatever or in respect of any mode or principle of construction of the article.

No claim is made by virtue of the registration to any right to the exclusive use of the words, letters, numbers, colour, combination or Trade Marks as appearing in the representation.

Date: 26/11/2021

353737-001

26 NOV 2021

Ms. DHARTI SHAH
(Authorized Agent of the Applicant)
(IN/PA- 2590)

(REPRESENTATION SHEETS)

NAME OF THE APPLICANT
KEVAL BHAVSAR
JAIMIN PANCHAI
DHARMIK GOHEL
JAY KHATRI
HITESH PRAJAPATI

NO. OF SHEETS - 3
SHEET NO. - 3

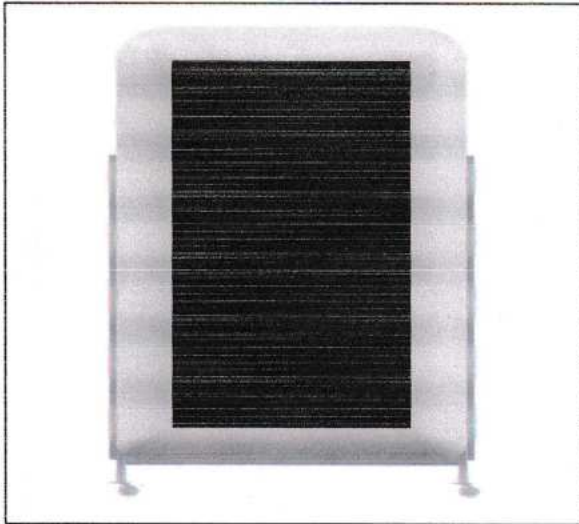

LEFT SIDE VIEW

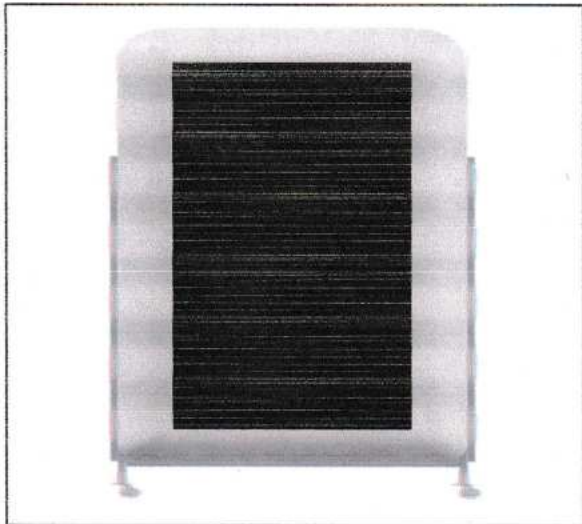

RIGHT SIDE VIEW

The novelty resides in the shape and configuration of the '**BODY AND CLOTH DRYER**' as illustrated.

No claim is made by virtue of this registration in respect of any mechanical or other action of the mechanism whatever or in respect of any mode or principle of construction of the article.

No claim is made by virtue of the registration to any right to the exclusive use of the words, letters, numbers, colour, combination or Trade Marks as appearing in the representation.

Date: 26/11/2021

353737-001

26 NOV 2021

Ms. DHARTI SHAH
(Authorized Agent of the Applicant)
(IN/PA- 2590)

DESIGN NUMBER	353709-010	
CLASS	02-02	
MILAN NARSHIBHAI MENDPARA, 8TH FLOOR, 813, RAGHUVIR TEXTILE MALL, B/H. D. R. WORLD MALL, AAI MATA ROAD, DUMBHAL, SURAT-395010, INDIA		
DATE OF REGISTRATION	26/11/2021	
TITLE	LADIES GARMENT (SET)	
PRIORITY NA		
DESIGN NUMBER	353716-006	
CLASS	06-01	
SHRI PARVEEN KUMAR, NEAR KHERI WALI CHOPAL, DHANKOT (49), GURGAON, HARYANA - 122505, INDIA		
DATE OF REGISTRATION	26/11/2021	
TITLE	SALON CHAIR	
PRIORITY NA		
DESIGN NUMBER	353737-001	
CLASS	15-05	
1. KEVAL BHAVSAR, SILVER OAK UNIVERSITY CAMPUS, OPP. BHAGWAT VIDYAPITH, S.G ROAD, GOTA, AHMEDABAD – 382481, INDIA 2. JAIMIN PANCHAL, SILVER OAK UNIVERSITY CAMPUS, OPP. BHAGWAT VIDYAPITH, S.G ROAD, GOTA, AHMEDABAD – 382481, INDIA 3. DHARMIK GOHEL, SILVER OAK UNIVERSITY CAMPUS, OPP. BHAGWAT VIDYAPITH, S.G ROAD, GOTA, AHMEDABAD – 382481, INDIA 4. JAY KHATRI, SILVER OAK UNIVERSITY CAMPUS, OPP. BHAGWAT VIDYAPITH, S.G ROAD, GOTA, AHMEDABAD – 382481, INDIA , ET AL.		
DATE OF REGISTRATION	26/11/2021	
TITLE	BODY AND CLOTH DRYER	
PRIORITY NA		



ORIGINAL

No. 108156

भारत सरकार
GOVERNMENT OF INDIA
पेटेंट कार्यालय
THE PATENT OFFICE

CERTIFICATE OF REGISTRATION OF DESIGN

Design No. 353739-001
Date 26/11/2021 16:11:15
Reciprocity Date*
Country

Certified that the design of which a copy is annexed hereto has been registered as of the number and date given above in class 12-05 in respect of the application of such design to CONVEYOR MACHINE in the name of 1.KEVAL BHAVSAR, SILVER OAK UNIVERSITY CAMPUS, OPP. BHAGWAT VIDYAPITH, S.G ROAD, GOTTA, AHMEDABAD – 382481, INDIA 2. JAIMIN PANCHAL, SILVER OAK UNIVERSITY CAMPUS, OPP. BHAGWAT VIDYAPITH, S.G ROAD, GOTTA, AHMEDABAD – 382481, INDIA 3. DHARMIK GOHEL, SILVER OAK UNIVERSITY CAMPUS, OPP. BHAGWAT VIDYAPITH, S.G ROAD, GOTTA, AHMEDABAD – 382481, INDIA 4. HITESH PRAJAPATI, SILVER OAK UNIVERSITY CAMPUS, OPP. BHAGWAT VIDYAPITH, S.G ROAD, GOTTA, AHMEDABAD – 382481, INDIA, ET AL.

in pursuance of and subject to the provisions of the Designs Act, 2000 and the Designs Rules, 2001.

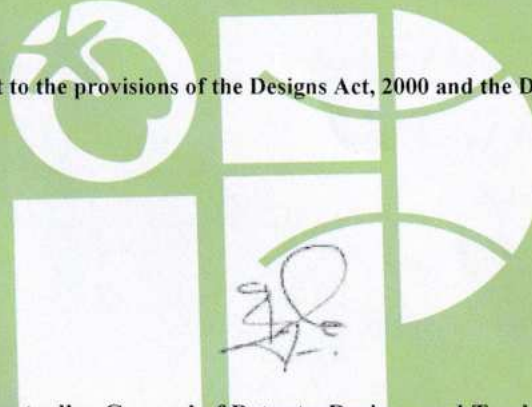

Controller General of Patents, Designs and Trade Marks

*The reciprocity date (if any) which has been allowed and the name of the country.

Copyright in the design will subsist for ten years from the date of Registration, and may under the terms of the Act and Rules, be extended for a further period of five years.

This Certificate is not for use in legal proceedings or for obtaining registration abroad

MS. DHARTI SHAH,
VERITE ASSOCIATES, 105, SCARLET GATEWAY, NR.
SPIPA ACADEMY, CORPORATE ROAD,
PRAHALADNAGR, AHMEDABAD-380015, GUJARAT,
INDIA

Date of Issue 01/02/2022 16:32:39

(REPRESENTATION SHEETS)

NAME OF THE APPLICANT
KEVAL BHAVSAR
JAIMIN PANCHAI
DHARMIK GOHEL
JAY KHATRI
HITESH PRAJAPATI

NO. OF SHEETS - 3
SHEET NO. - 1

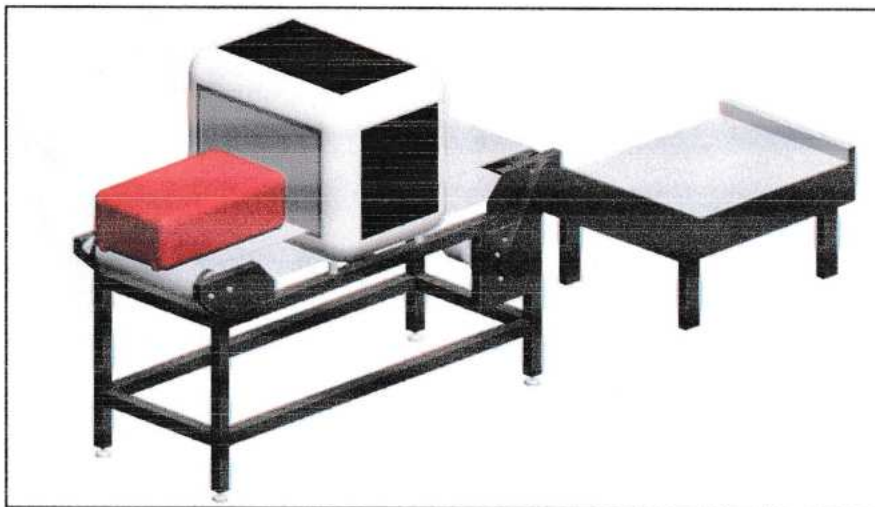

PERSPECTIVE VIEW

The novelty resides in the shape and configuration of the '**CONVEYOR MACHINE**' as illustrated.

No claim is made by virtue of this registration in respect of any mechanical or other action of the mechanism whatever or in respect of any mode or principle of construction of the article.

No claim is made by virtue of the registration to any right to the exclusive use of the words, letters, numbers, colour, combination or Trade Marks as appearing in the representation.

353739-001

26 NOV 2021

Ms. DHARTI SHAH
(Authorized Agent of the Applicant)
(IN/PA- 2590)

(REPRESENTATION SHEETS)

NAME OF THE APPLICANT
KEVAL BHAVSAR
JAIMIN PANCHAI
DHARMIK GOHEL
JAY KHATRI
HITESH PRAJAPATI

NO. OF SHEETS - 3
SHEET NO. - 2

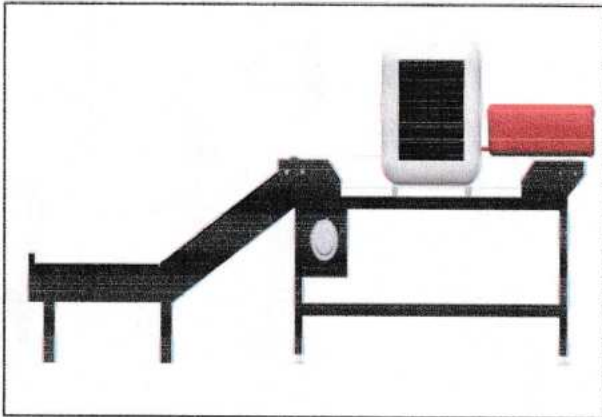

LEFT SIDE VIEW

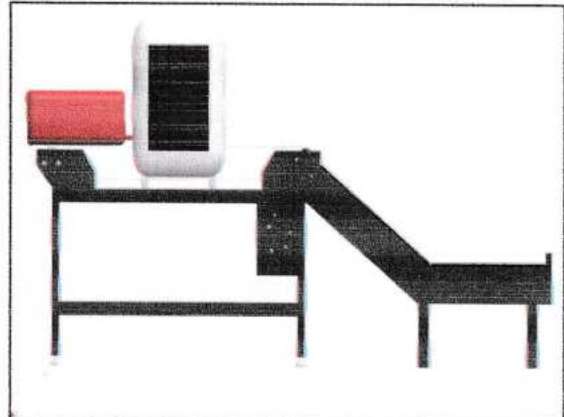

RIGHT SIDE VIEW

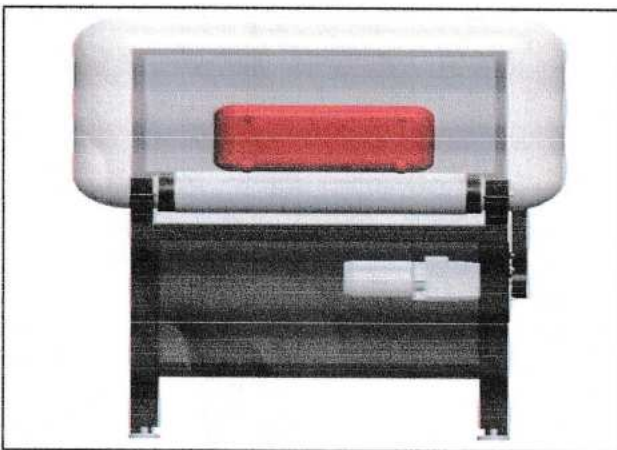

FRONT VIEW

The novelty resides in the shape and configuration of the 'CONVEYOR MACHINE' as illustrated.

No claim is made by virtue of this registration in respect of any mechanical or other action of the mechanism whatever or in respect of any mode or principle of construction of the article.

No claim is made by virtue of the registration to any right to the exclusive use of the words, letters, numbers, colour, combination or Trade Marks as appearing in the representation.

353739-001

26 NOV 2021

Ms. DHARTI SHAH
(Authorized Agent of the Applicant)
(IN/PA- 2590)

(REPRESENTATION SHEETS)

NAME OF THE APPLICANT
KEVAL BHAVSAR
JAIMIN PANCHAI
DHARMIK GOHEL
JAY KHATRI
HITESH PRAJAPATI

NO. OF SHEETS - 3
SHEET NO. - 3

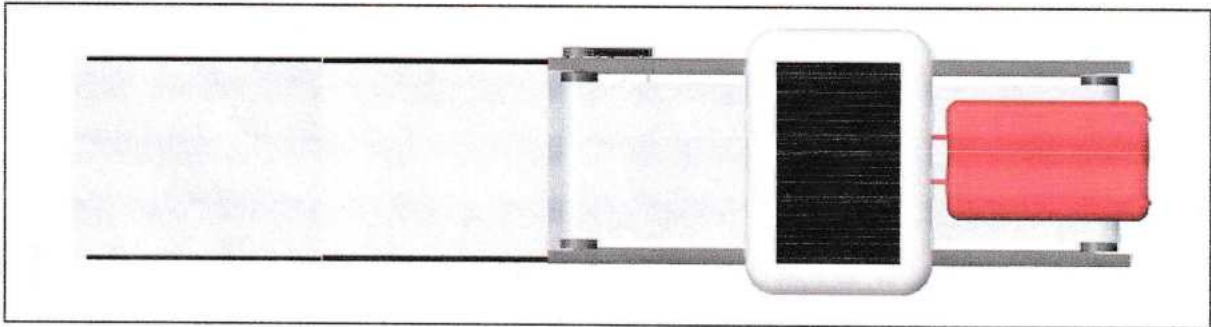

TOP VIEW

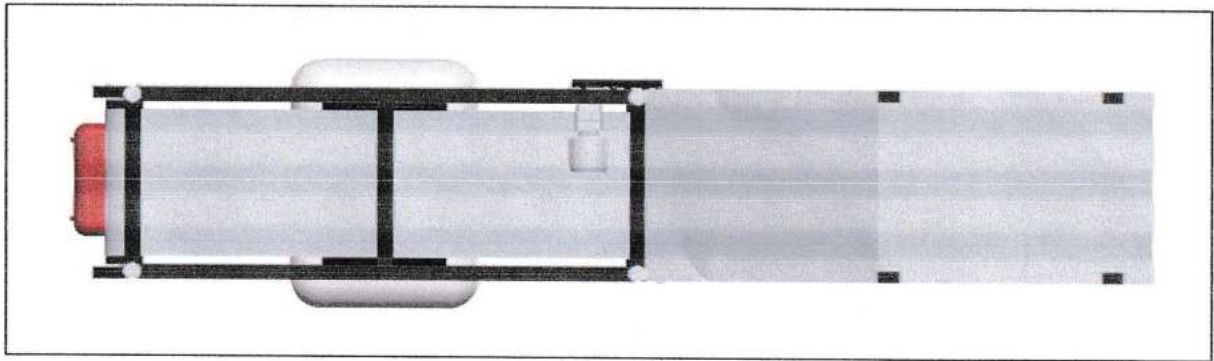

BOTTOM VIEW

The novelty resides in the shape and configuration of the 'CONVEYOR MACHINE' as illustrated.

No claim is made by virtue of this registration in respect of any mechanical or other action of the mechanism whatever or in respect of any mode or principle of construction of the article.

No claim is made by virtue of the registration to any right to the exclusive use of the words, letters, numbers, colour, combination or Trade Marks as appearing in the representation.

353739 - 001

26 NOV 2021

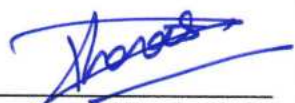
Ms. DHARTI SHAH
(Authorized Agent of the Applicant)
(IN/PA- 2590)

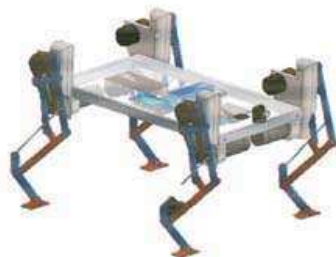
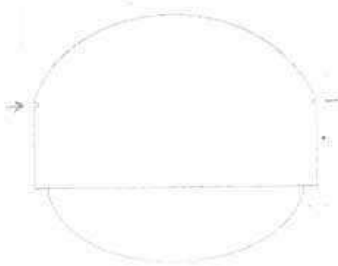
DESIGN NUMBER	353739-001	
CLASS	12-05	
1.KEVAL BHAVSAR, SILVER OAK UNIVERSITY CAMPUS, OPP. BHAGWAT VIDYAPITH, S.G ROAD, GOTA, AHMEDABAD – 382481, INDIA 2. JAIMIN PANCHAL, SILVER OAK UNIVERSITY CAMPUS, OPP. BHAGWAT VIDYAPITH, S.G ROAD, GOTA, AHMEDABAD – 382481, INDIA 3. DHARMIK GOHEL, SILVER OAK UNIVERSITY CAMPUS, OPP. BHAGWAT VIDYAPITH, S.G ROAD, GOTA, AHMEDABAD – 382481, INDIA 4. HITESH PRAJAPATI, SILVER OAK UNIVERSITY CAMPUS, OPP. BHAGWAT VIDYAPITH, S.G ROAD, GOTA, AHMEDABAD – 382481, INDIA , ET AL.		
DATE OF REGISTRATION	26/11/2021	
TITLE	CONVEYOR MACHINE	
PRIORITY NA		
DESIGN NUMBER	353741-001	
CLASS	15-99	
1.JENISH PATEL, SILVER OAK UNIVERSITY CAMPUS, OPP. BHAGWAT VIDYAPITH, S.G ROAD, GOTA, AHMEDABAD – 382421, INDIA 2. AMIT SHAH, SILVER OAK UNIVERSITY CAMPUS, OPP. BHAGWAT VIDYAPITH, S.G ROAD, GOTA, AHMEDABAD – 382421, INDIA		
DATE OF REGISTRATION	26/11/2021	
TITLE	INDUSTRIAL ROBOT	
PRIORITY NA		
DESIGN NUMBER	307405	
CLASS	28-01	
NON DESTRUCTIVE ENGINEERING COMPANY LTD., 15-C, LAXMI INDUSTRIAL ESTATE, NEW LINK ROAD, ANDHERI WEST, MUMBAI 400053, STATE OF MAHARASHTRA, INDIA		
DATE OF REGISTRATION	05/07/2018	
TITLE	CAPSULE	
PRIORITY NA		



ORIGINAL

No. 109802

भारत सरकार
GOVERNMENT OF INDIA
पेटेंट कार्यालय
THE PATENT OFFICE

CERTIFICATE OF REGISTRATION OF DESIGN

Design No. 356367-001
Date 08/01/2022 17:05:37
Reciprocity Date*
Country

Certified that the design of which a copy is annexed hereto has been registered as of the number and date given above in class 12-11 in respect of the application of such design to SIDE VIEW MIRROR FOR TWO WHEELER VEHICLE in the name of 1.MANSI JITENDRABHAI DAVE, SILVER OAK UNIVERSITY CAMPUS, OPP. BHAGWAT VIDYAPITH, S.G ROAD, GOTA, AHMEDABAD - 382421, INDIA 2. JENICE PRAKASHKUMAR BHAVSAR, SILVER OAK UNIVERSITY CAMPUS, OPP. BHAGWAT VIDYAPITH, S.G ROAD, GOTA, AHMEDABAD - 382421, INDIA

in pursuance of and subject to the provisions of the Designs Act, 2000 and the Designs Rules, 2001.

Controller General of Patents, Designs and Trade Marks

*The reciprocity date (if any) which has been allowed and the name of the country.

Copyright in the design will subsist for ten years from the date of Registration, and may under the terms of the Act and Rules, be extended for a further period of five years.

This Certificate is not for use in legal proceedings or for obtaining registration abroad

MS. DHARTI SHAH,
VERITE ASSOCIATES, 105, SCARLET GATEWAY,
NR. SPIPA ACADEMY, CORPORATE ROAD,
PRAHALADNAGR, AHMEDABAD-380015,
GUJARAT, INDIA

Date of Issue 04/03/2022 16:27:24

(REPRESENTATION SHEETS)

NAME OF THE APPLICANT
MANSI JITENDRABHAI DAVE
JENICE PRAKASHKUMAR BHAVSAR

NO. OF SHEETS - 3
SHEET NO. - 1



PERSPECTIVE VIEW

The novelty resides in the shape and configuration of the '**SIDE VIEW MIRROR FOR TWO WHEELER VEHICLE**' as illustrated.

No claim is made by virtue of this registration in respect of any mechanical or other action of the mechanism whatever or in respect of any mode or principle of construction of the article.

No claim is made by virtue of the registration to any right to the exclusive use of the words, letters, numbers, colour, combination or Trade Marks as appearing in the representation.

356367-001

08 JAN 2022

Dated this 8th day January of 2022.

Ms. DHARTI SHAH
(Authorized Agent of the Applicant)
(IN/PA- 2590)

(REPRESENTATION SHEETS)

NAME OF THE APPLICANT
MANSI JITENDRABHAI DAVE
JENICE PRAKASHKUMAR BHAVSAR

NO. OF SHEETS - 3
SHEET NO. - 2



FRONT VIEW



BACK VIEW

The novelty resides in the shape and configuration of the 'SIDE VIEW MIRROR FOR TWO WHEELER VEHICLE' as illustrated.

No claim is made by virtue of this registration in respect of any mechanical or other action of the mechanism whatever or in respect of any mode or principle of construction of the article.

No claim is made by virtue of the registration to any right to the exclusive use of the words, letters, numbers, colour, combination or Trade Marks as appearing in the representation.

356367 -001

08 JAN 2022

Dated this 8th day January of 2022.

Ms. DHARTI SHAH
(Authorized Agent of the Applicant)
(IN/PA- 2590)

(REPRESENTATION SHEETS)

NAME OF THE APPLICANT
MANSI JITENDRABHAI DAVE
JENICE PRAKASHKUMAR BHAVSAR

NO. OF SHEETS - 3
SHEET NO. - 3



TOP VIEW



BOTTOM VIEW



SIDE VIEW

The novelty resides in the shape and configuration of the 'SIDE VIEW MIRROR FOR TWO WHEELER VEHICLE' as illustrated.

No claim is made by virtue of this registration in respect of any mechanical or other action of the mechanism whatever or in respect of any mode or principle of construction of the article.



No claim is made by virtue of the registration to any right to the exclusive use of the words, letters, numbers, colour, combination or Trade Marks as appearing in the representation.

356367 -001

08 JAN 2022

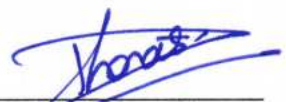
Dated this 8th day January of 2022.

Ms. DHARTI SHAH
(Authorized Agent of the Applicant)
(IN/PA- 2590)

DESIGN NUMBER	356332-001	
CLASS	12-11	
BOOMA INNOVATIVE TRANSPORT SOLUTIONS PRIVATE LIMITED NO. A9, SIDCO INDUSTRIAL ESTATE, COIMBATORE - 641 021		
DATE OF REGISTRATION	07/01/2022	
TITLE	CYBER SCOOTER	
PRIORITY NA		
DESIGN NUMBER	356348-001	
CLASS	10-07	
HARDIK RAMJIBHAI ASODARIYA C-1004, SAIPOOJA RESIDENCY, B/H OPERA CITY, UTRAN, SURAT		
DATE OF REGISTRATION	08/01/2022	
TITLE	WATCH DIAL	
PRIORITY NA		
DESIGN NUMBER	356367-001	
CLASS	12-11	
1.MANSI JITENDRABHAI DAVE SILVER OAK UNIVERSITY CAMPUS, OPP. BHAGWAT VIDYAPITH, S.G ROAD, GOTA, AHMEDABAD – 382421, INDIA 2. JENICE PRAKASHKUMAR BHAVSAR SILVER OAK UNIVERSITY CAMPUS, OPP. BHAGWAT VIDYAPITH, S.G ROAD, GOTA, AHMEDABAD – 382421, INDIA		
DATE OF REGISTRATION	08/01/2022	
TITLE	SIDE VIEW MIRROR FOR TWO WHEELER VEHICLE	
PRIORITY NA		



ORIGINAL

No. 110485

भारत सरकार
GOVERNMENT OF INDIA
पेटेंट कार्यालय
THE PATENT OFFICE

CERTIFICATE OF REGISTRATION OF DESIGN

Design No. 356374-001
Date 08/01/2022 17:05:37
Reciprocity Date*
Country

Certified that the design of which a copy is annexed hereto has been registered as of the number and date given above in class 13-04 in respect of the application of such design to SILVER SOLAR TREE in the name of 1.PROF. MANAN PATHAK, SILVER OAK UNIVERSITY CAMPUS, OPP. BHAGWAT VIDYAPITH, S.G ROAD, GOTA, AHMEDABAD - 382421, INDIA 2. JAY PATEL, SILVER OAK UNIVERSITY CAMPUS, OPP. BHAGWAT VIDYAPITH, S.G ROAD, GOTA, AHMEDABAD -- 382421, INDIA 3. SAGAR SONI, SILVER OAK UNIVERSITY CAMPUS, OPP. BHAGWAT VIDYAPITH, S.G ROAD, GOTA, AHMEDABAD - 382421, INDIA

in pursuance of and subject to the provisions of the Designs Act, 2000 and the Designs Rules, 2001.

Controller General of Patents, Designs and Trade Marks

*The reciprocity date (if any) which has been allowed and the name of the country.

Copyright in the design will subsist for ten years from the date of Registration, and may under the terms of the Act and Rules, be extended for a further period of five years.

This Certificate is not for use in legal proceedings or for obtaining registration abroad

MS. DHARTI SHAH,
VERITE ASSOCIATES, 105, SCARLET GATEWAY,
NR. SPIPA ACADEMY, CORPORATE ROAD,
PRAHALADNAGR, AHMEDABAD-380015.
GUJARAT, INDIA

Date of Issue 17/03/2022 15:35:47

(REPRESENTATION SHEETS)

NAME OF THE APPLICANT
PROF. MANAN PATHAK
JAY PATEL
SAGAR SONI

NO. OF SHEETS - 3
SHEET NO. - 1

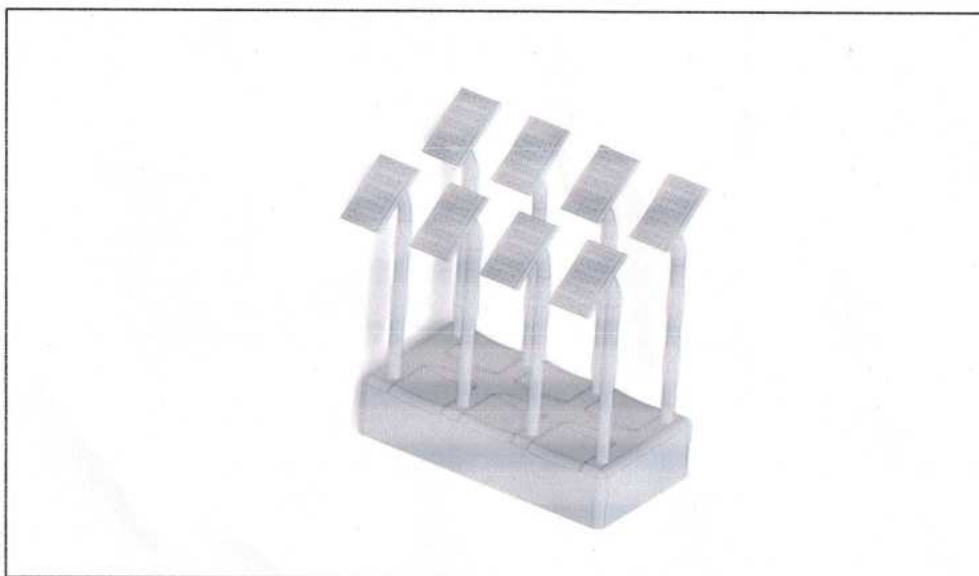

PERSPECTIVE VIEW

The novelty resides in the shape and configuration of the 'SILVER SOLAR TREE' as illustrated.

No claim is made by virtue of this registration in respect of any mechanical or other action of the mechanism whatever or in respect of any mode or principle of construction of the article.

No claim is made by virtue of the registration to any right to the exclusive use of the words, letters, numbers, colour, combination or Trade Marks as appearing in the representation.

356374-001

08 JAN 2022

Dated this 8th day January of 2022.

Ms. DHARTI SHAH
(Authorized Agent of the Applicant)
(IN/PA- 2590)

(REPRESENTATION SHEETS)

NAME OF THE APPLICANT
PROF. MANAN PATHAK
JAY PATEL
SAGAR SONI

NO. OF SHEETS - 3
SHEET NO. - 2

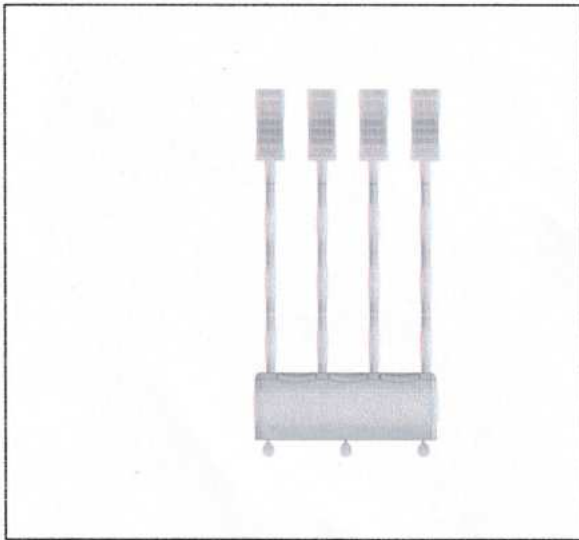

FRONT VIEW

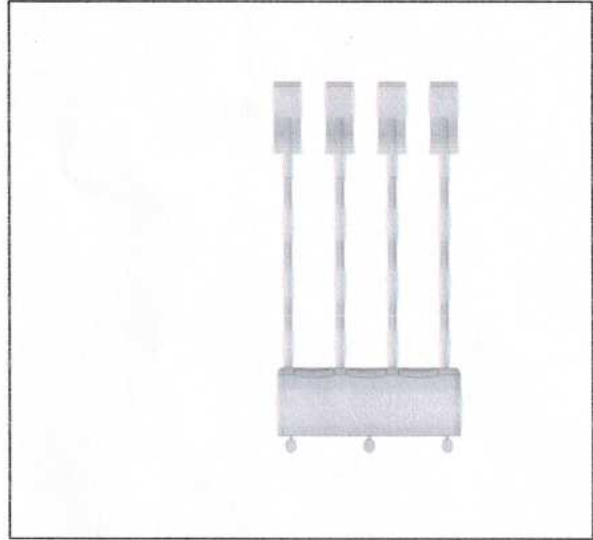

BOTTOM VIEW

The novelty resides in the shape and configuration of the 'SILVER SOLAR TREE' as illustrated.

No claim is made by virtue of this registration in respect of any mechanical or other action of the mechanism whatever or in respect of any mode or principle of construction of the article.

No claim is made by virtue of the registration to any right to the exclusive use of the words, letters, numbers, colour, combination or Trade Marks as appearing in the representation.

356374 - 001

08 JAN 2022

Dated this 8th day January of 2022.

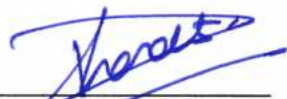
MS. DHARTI SHAH
(Authorized Agent of the Applicant)
(IN/PA- 2590)

(REPRESENTATION SHEETS)

NAME OF THE APPLICANT
PROF. MANAN PATHAK
JAY PATEL
SAGAR SONI

NO. OF SHEETS - 3
SHEET NO. - 3

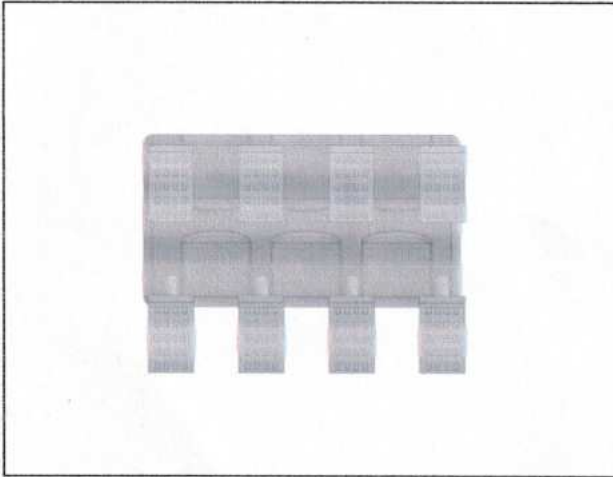

TOP VIEW

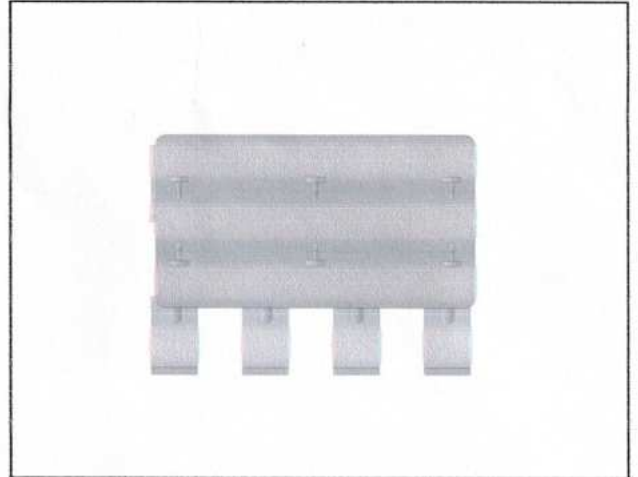

BOTTOM VIEW

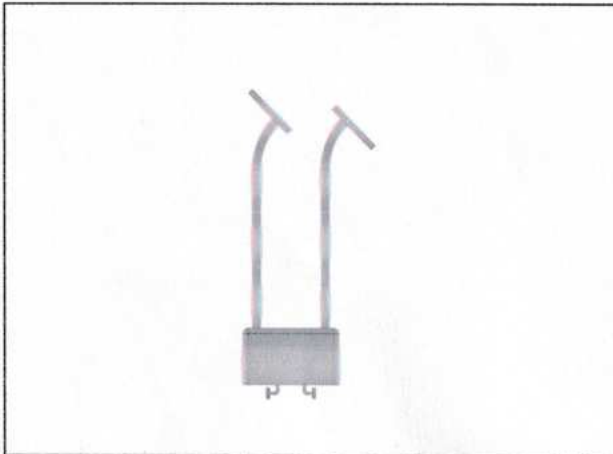

SIDE VIEW

The novelty resides in the shape and configuration of the 'SILVER SOLAR TREE' as illustrated.

No claim is made by virtue of this registration in respect of any mechanical or other action of the mechanism whatever or in respect of any mode or principle of construction of the article.



No claim is made by virtue of the registration to any right to the exclusive use of the words, letters, numbers, colour, combination or Trade Marks as appearing in the representation.

356374-001

08 JAN 2022

Dated this 8th day January of 2022.

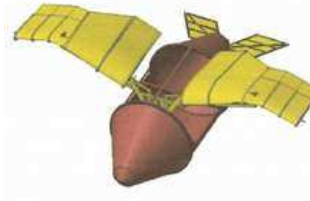
Ms. DHARTI SHAH
(Authorized Agent of the Applicant)
(IN/PA- 2590)

DESIGN NUMBER	356374-001		
CLASS	13-04		
1.PROF. MANAN PATHAK SILVER OAK UNIVERSITY CAMPUS, OPP. BHAGWAT VIDYAPITH, S.G ROAD, GOTA, AHMEDABAD – 382421, INDIA 2. JAY PATEL SILVER OAK UNIVERSITY CAMPUS, OPP. BHAGWAT VIDYAPITH, S.G ROAD, GOTA, AHMEDABAD – 382421, INDIA 3. SAGAR SONI SILVER OAK UNIVERSITY CAMPUS, OPP. BHAGWAT VIDYAPITH, S.G ROAD, GOTA, AHMEDABAD – 382421, INDIA			
DATE OF REGISTRATION	08/01/2022		
TITLE	SILVER SOLAR TREE		
PRIORITY NA			
DESIGN NUMBER	356381-001		
CLASS	24-01		
1.RITU MAITY RESEARCH SCHOLAR, SCHOOL OF MECH. ENGG., KIIT, BHUBANESWAR & SR. ENGINEER, CTTC, MSME TOOL ROOM, BHUBANESWAR, 751024 ODISHA INDIA 2. DR. RUBY MISHRA ASSOCIATE PROFESSOR, SCHOOL OF MECH. ENGG., KIIT, BHUBANESWAR, ODISHA 751024 INDIA 3. DR. PRASANT KUMAR PATNAIK PROFESSOR, SCHOOL OF COMPUTER ENGINEERING, KIIT, BHUBANESWAR, 751024 ODISHA INDIA			
DATE OF REGISTRATION	09/01/2022		
TITLE	FLAPPING WING ROBOTIC DISINFECTION EQUIPMENT FOR SPRAYING DISINFECTANT IN PREMISE		
PRIORITY NA			
DESIGN NUMBER	356398-001		
CLASS	10-07		
MONTRES TUDOR SA 3, RUE FRANÇOIS DUSSAUD, 1211 GENÈVE 26, SWITZERLAND			
DATE OF REGISTRATION	10/01/2022		
TITLE	CLASP FOR WATCH BRACELET		
PRIORITY			
PRIORITY NUMBER	DATE	COUNTRY	
146218	20/07/2021	SWITZERLAND	



सत्यमेव जयते

भारत सरकार
GOVERNMENT OF INDIA
पेटेंट कार्यालय
THE PATENT OFFICE

ORIGINAL

No. 104503

CERTIFICATE OF REGISTRATION OF DESIGN

Design No. 349847-001
Date 20/09/2021 20:16:25
Reciprocity Date*
Country

Certified that the design of which a copy is annexed hereto has been registered as of the number and date given above in class 12-16 in respect of the application of such design to ROLL CAGE STRUCTURE in the name of 1.VIRAT DHOLAKIYA, SILVER OAK UNIVERSITY CAMPUS, OPP. BHAGWAT VIDYAPITH, S.G ROAD, GOTA, AHMEDABAD - 382421 2. KRUTARTH TRIVEDI, SILVER OAK UNIVERSITY CAMPUS, OPP. BHAGWAT VIDYAPITH, S.G ROAD, GOTA, AHMEDABAD - 382421

in pursuance of and subject to the provisions of the Designs Act, 2000 and the Designs Rules, 2001.

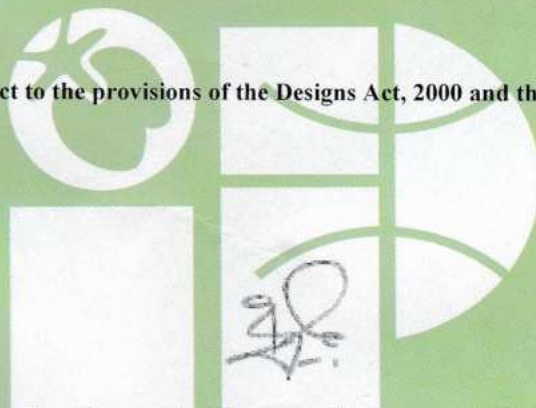

Controller General of Patents, Designs and Trade Marks

*The reciprocity date (if any) which has been allowed and the name of the country.

Copyright in the design will subsist for ten years from the date of Registration, and may under the terms of the Act and Rules, be extended for a further period of five years.

This Certificate is not for use in legal proceedings or for obtaining registration abroad

MS. DHARTI SHAH,
VERITE ASSOCIATES, 105, SCARLET GATEWAY, NR.
SPIPA ACADEMY, CORPORATE ROAD,
PRAHALADNAGR, AHMEDABAD-380015, GUJARAT,
INDIA

Date of Issue 09/11/2021 16:39:23

INTELLECTUAL
PROPERTY INDIA
PATENTS | DESIGNS | TRADE MARKS
GEOGRAPHICAL INDICATIONS

(REPRESENTATION SHEETS)

NAME OF THE APPLICANT
VIRAT DHOLAKIYA
KRUTARTH TRIVEDI

NO. OF SHEETS - 3
SHEET NO. - 1

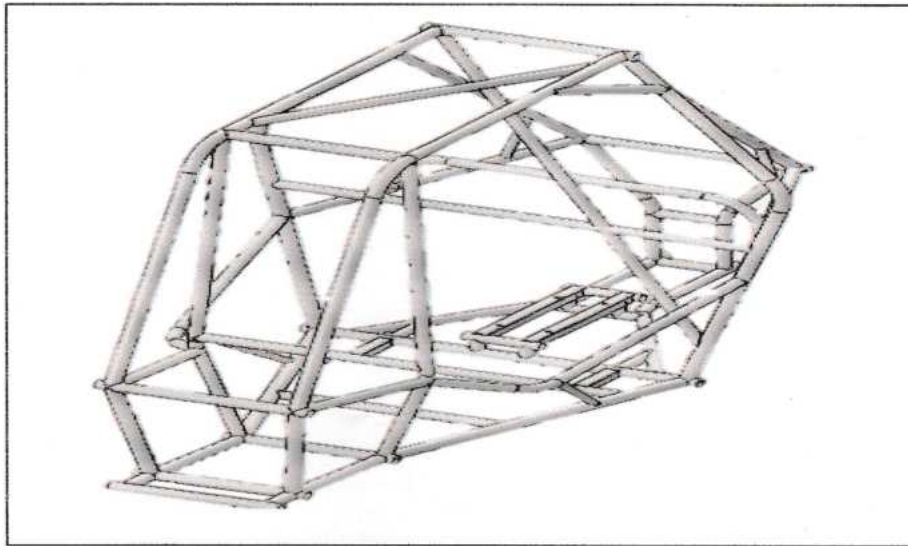

PERSPECTIVE VIEW

The novelty resides in the shape and configuration of the 'ROLLCAGE STRUCTURE' as illustrated.

~~A Rollcage Structure is specially designed chassis for all-terrain vehicle to make the structure safe and light in weight.~~

No claim is made by virtue of this registration in respect of any mechanical or other action of the mechanism whatever or in respect of any mode or principle of construction of the article.

No claim is made by virtue of the registration to any right to the exclusive use of the words, letters, numbers, colour, combination or Trade Marks as appearing in the representation.

349847-001

20 SEP 2021

Ms. DHARTI SHAH
(Authorized Agent of the Applicant)
(IN/PA- 2590)

(REPRESENTATION SHEETS)

NAME OF THE APPLICANT
VIRAT DHOLAKIYA
KRUTARTH TRIVEDI

NO. OF SHEETS - 3
SHEET NO. - 2

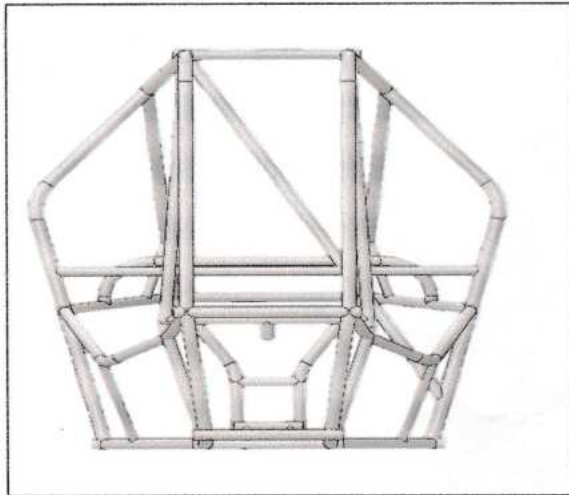

FRONT VIEW

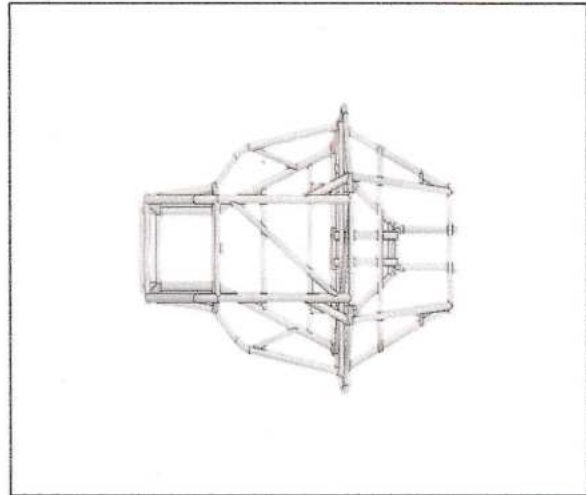

TOP VIEW

The novelty resides in the shape and configuration of the '**ROLLCAGE STRUCTURE**' as illustrated.

~~A Rollcage Structure is specially designed chassis for all-terrain vehicle to make the structure safe and light in weight.~~

No claim is made by virtue of this registration in respect of any mechanical or other action of the mechanism whatever or in respect of any mode or principle of construction of the article.

No claim is made by virtue of the registration to any right to the exclusive use of the words, letters, numbers, colour, combination or Trade Marks as appearing in the representation.

349847-001
20 SEP 2021

Ms. DHARTI SHAH
(Authorized Agent of the Applicant)
(IN/PA- 2590)

(REPRESENTATION SHEETS)

NAME OF THE APPLICANT
VIRAT DHOLAKIYA
KRUTARTH TRIVEDI

NO. OF SHEETS - 3
SHEET NO. - 3

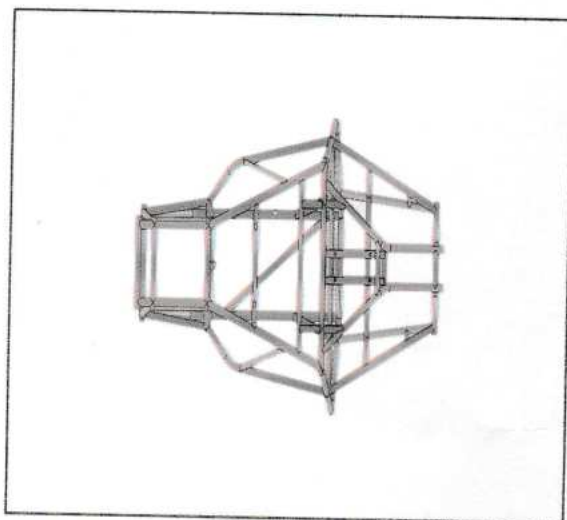

BOTTOM VIEW

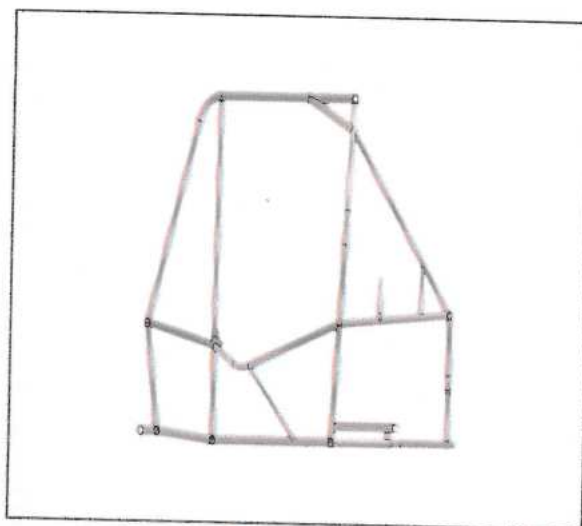

LEFT SIDE VIEW

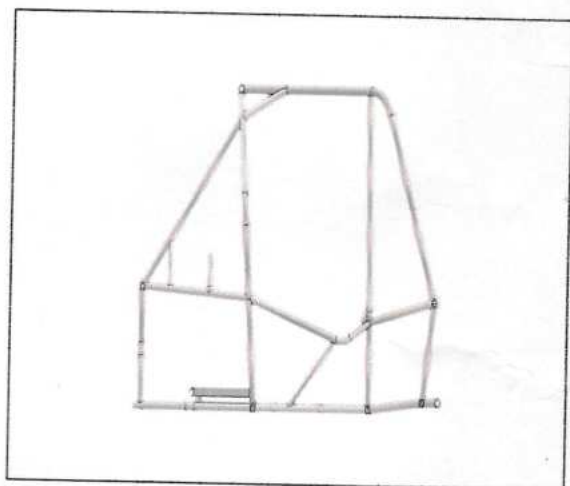

RIGHT SIDE VIEW

The novelty resides in the shape and configuration of the 'ROLLCAGE STRUCTURE' as illustrated.

A Rollcage Structure is specially designed chassis for all-terrain vehicle to make the structure safe and light in weight.



No claim is made by virtue of this registration in respect of any mechanical or other action of the mechanism whatever or in respect of any mode or principle of construction of the article.

No claim is made by virtue of the registration to any right to the exclusive use of the words, letters, numbers, colour, combination or Trade Marks as appearing in the representation.

349847-001

20 SEP 2021

Ms. DHARTI SHAH
(Authorized Agent of the Applicant)
(IN/PA- 2590)

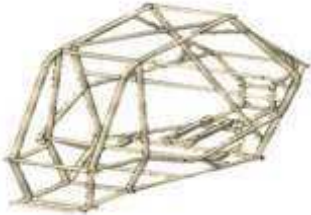
DESIGN NUMBER	334333-001	
CLASS	05-05	
FABINDIA OVERSEAS PRIVATE LIMITED, N-14, GREATER KAILASH, PART I, NEW DELHI-110048, INDIA		
DATE OF REGISTRATION	16/10/2020	
TITLE	TEXTILE FABRIC	
PRIORITY NA		
DESIGN NUMBER	334335-001	
CLASS	05-05	
FABINDIA OVERSEAS PRIVATE LIMITED, N-14, GREATER KAILASH, PART I, NEW DELHI-110048, INDIA		
DATE OF REGISTRATION	16/10/2020	
TITLE	TEXTILE FABRIC	
PRIORITY NA		
DESIGN NUMBER	349847-001	
CLASS	12-16	
1.VIRAT DHOLAKIYA, SILVER OAK UNIVERSITY CAMPUS, OPP. BHAGWAT VIDYAPITH, S.G ROAD, GOTA, AHMEDABAD - 382421 2. KRUTARTH TRIVEDI, SILVER OAK UNIVERSITY CAMPUS, OPP. BHAGWAT VIDYAPITH, S.G ROAD, GOTA, AHMEDABAD - 382421		
DATE OF REGISTRATION	20/09/2021	
TITLE	ROLLCAGE STRUCTURE	
PRIORITY NA		



ORIGINAL

No. 106346

सत्यमेव जयते
भारत सरकार
GOVERNMENT OF INDIA
पेटेंट कार्यालय
THE PATENT OFFICE

CERTIFICATE OF REGISTRATION OF DESIGN

Design No. 350648-001
Date 04/10/2021 19:51:10
Reciprocity Date*
Country

Certified that the design of which a copy is annexed hereto has been registered as of the number and date given above in class 12-16 in respect of the application of such design to ROLL CAGE STRUCTURE in the name of 1. VIRAT DHOLAKIYA, SILVER OAK UNIVERSITY CAMPUS, OPP. BHAGWAT VIDYAPITH, S.G ROAD, GOTA, AHMEDABAD - 382421, INDIA 2. YASH MOHNOT, SILVER OAK UNIVERSITY CAMPUS, OPP. BHAGWAT VIDYAPITH, S.G ROAD, GOTA, AHMEDABAD - 382421, INDIA

in pursuance of and subject to the provisions of the Designs Act, 2000 and the Designs Rules, 2001.

Controller General of Patents, Designs and Trade Marks

*The reciprocity date (if any) which has been allowed and the name of the country.

Copyright in the design will subsist for ten years from the date of Registration, and may under the terms of the Act and Rules, be extended for a further period of five years.

This Certificate is not for use in legal proceedings or for obtaining registration abroad

MS. DHARTI SHAH,
VERITE ASSOCIATES, 105, SCARLET GATEWAY, NR.
SPIPA ACADEMY, CORPORATE ROAD,
PRAHALADNAGR, AHMEDABAD-380015, GUJARAT,
INDIA

Date of Issue 21/12/2021 13:27:55

INTELLECTUAL
PROPERTY INDIA
PATENTS | DESIGNS | TRADE MARKS
GEOGRAPHICAL INDICATIONS

(REPRESENTATION SHEETS)

NAME OF THE APPLICANT
VIRAT DHOLAKIYA
YASH MOHNOT

NO. OF SHEETS - 3
SHEET NO. - 1



PERSPECTIVE VIEW

The novelty resides in the shape and configuration of the '**ROLLCAGE STRUCTURE**' as illustrated.

~~A Rollcage Structure is specially designed chassis for all-terrain vehicle to make the structure safe and light in weight.~~

No claim is made by virtue of this registration in respect of any mechanical or other action of the mechanism whatever or in respect of any mode or principle of construction of the article.

No claim is made by virtue of the registration to any right to the exclusive use of the words, letters, numbers, colour, combination or Trade Marks as appearing in the representation.

350648-001

04 OCT 2021

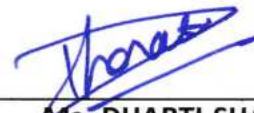
Ms. DHARTI SHAH
(Authorized Agent of the Applicant)
(IN/PA- 2590)

(REPRESENTATION SHEETS)

NAME OF THE APPLICANT
VIRAT DHOLAKIYA
YASH MOHNOT

NO. OF SHEETS - 3
SHEET NO. - 2



FRONT VIEW

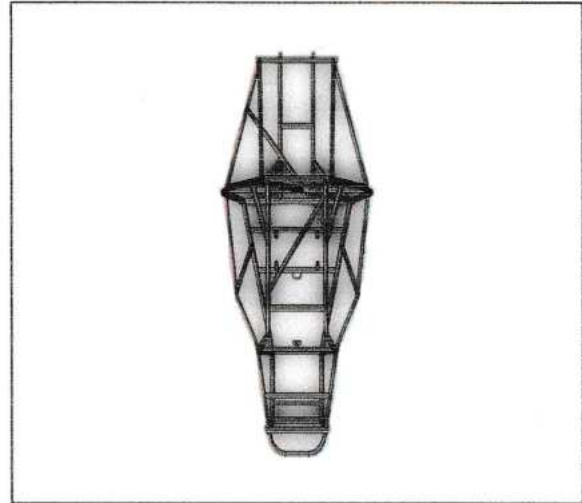

TOP VIEW

The novelty resides in the shape and configuration of the 'ROLLCAGE STRUCTURE' as illustrated.

~~A Rollcage Structure is specially designed chassis for all-terrain vehicle to make the structure safe and light in weight.~~

No claim is made by virtue of this registration in respect of any mechanical or other action of the mechanism whatever or in respect of any mode or principle of construction of the article.

No claim is made by virtue of the registration to any right to the exclusive use of the words, letters, numbers, colour, combination or Trade Marks as appearing in the representation.

350648 -001

04 OCT 2021



Ms. DHARTI SHAH
(Authorized Agent of the Applicant)
(IN/PA- 2590)

(REPRESENTATION SHEETS)

NAME OF THE APPLICANT
VIRAT DHOLAKIYA
YASH MOHNOT

NO. OF SHEETS - 3
SHEET NO. - 3

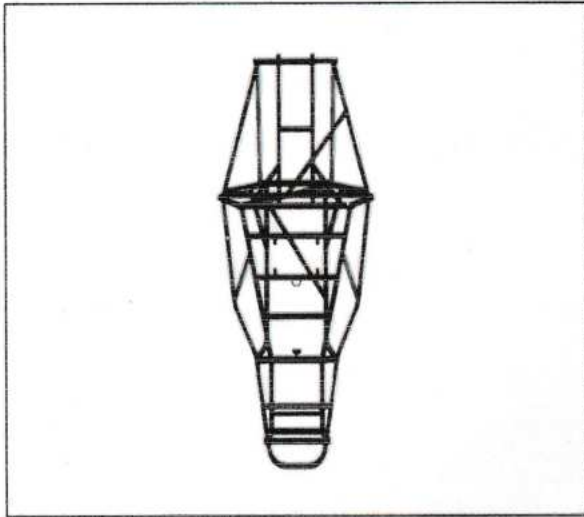

BOTTOM VIEW

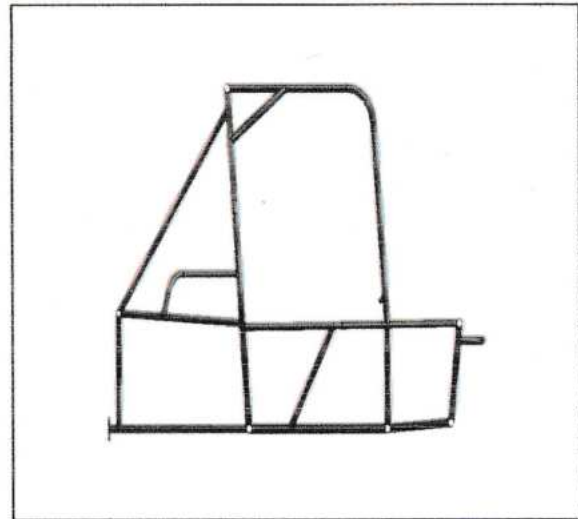

LEFT SIDE VIEW

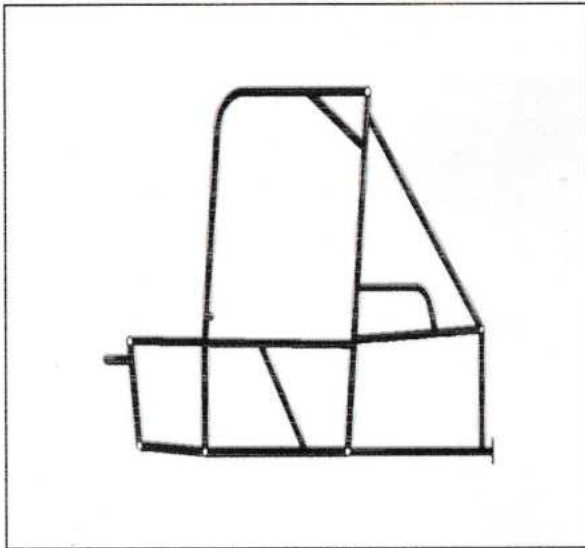

RIGHT SIDE VIEW

The novelty resides in the shape and configuration of the 'ROLLCAGE STRUCTURE' as illustrated.

A Rollcage Structure is specially designed chassis for all-terrain vehicle to make the structure safe and light in weight.



No claim is made by virtue of this registration in respect of any mechanical or other action of the mechanism whatever or in respect of any mode or principle of construction of the article.

No claim is made by virtue of the registration to any right to the exclusive use of the words, letters, numbers, colour, combination or Trade Marks as appearing in the representation.

350648-001

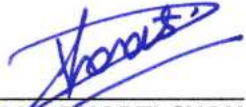
04 OCT 2021

MS. DHARTI SHAH
(Authorized Agent of the Applicant)
(IN/PA- 2590)

DESIGN NUMBER	350648-001	
CLASS	12-16	
1.VIRAT DHOLAKIYA, SILVER OAK UNIVERSITY CAMPUS, OPP. BHAGWAT VIDYAPITH, S.G ROAD, GOTA, AHMEDABAD – 382421, INDIA 2. YASH MOHNOT, SILVER OAK UNIVERSITY CAMPUS, OPP. BHAGWAT VIDYAPITH, S.G ROAD, GOTA, AHMEDABAD – 382421, INDIA		
DATE OF REGISTRATION	04/10/2021	
TITLE	ROLLCAGE STRUCTURE	
PRIORITY NA		
DESIGN NUMBER	350652-001	
CLASS	12-16	
1.RIPEN SHAH, SILVER OAK UNIVERSITY CAMPUS, OPP. BHAGWAT VIDYAPITH, S.G ROAD, GOTA, AHMEDABAD – 382421 2. MIT SHAH, SILVER OAK UNIVERSITY CAMPUS, OPP. BHAGWAT VIDYAPITH, S.G ROAD, GOTA, AHMEDABAD – 382421		
DATE OF REGISTRATION	04/10/2021	
TITLE	FRONT HUB	
PRIORITY NA		
DESIGN NUMBER	350729-001	
CLASS	24-02	
1.DR. BANDANA MAHAPATRA, ASSISTANT PROFESSOR, DEPARTMENT: SCHOOL OF DATA SCIENCE, SYMBIOSIS SKILLS AND PROFESSIONAL UNIVERSITY, VILLAGE - KIWALE, ADJOINING PUNE MUMBAI EXPRESSWAY, MAHARASHTRA, INDIA, PINCODE: 412101 2. DR. ANAND NAYYAR, LECTURER, RESEARCHER AND SCIENTIST, GRADUATE SCHOOL, DUY TAN UNIVERSITY, 254 NGUYEN VAN LINH STREET, GRADUATE SCHOOL, DA NANG 550000, VIET NAM 3. KUMARSANJAY K. BHOREKAR, ASSISTANT PROFESSOR, DEPARTMENT NAME: SCHOOL OF DATA SCIENCE & CSIT, SYMBIOSIS SKILLS AND PROFESSIONAL UNIVERSITY, VILLAGE - KIWALE, ADJOINING PUNE MUMBAI EXPRESSWAY, MAHARASHTRA, INDIA, PINCODE: 412101 4. DR. RUBY JAIN, ASSISTANT PROFESSOR, SCHOOL OF DATA SCIENCE, SYMBIOSIS SKILLS AND PROFESSIONAL UNIVERSITY, ADJOINING MUMBAI PUNE EXPRESSWAY KIWALE PUNE MAHARASHTRA INDIA 412101		
DATE OF REGISTRATION	05/10/2021	
TITLE	ANTI-THEFT DRUG SECURITY DEVICE	
PRIORITY NA		



ORIGINAL

No. 107789

भारत सरकार
GOVERNMENT OF INDIA
पेटेंट कार्यालय
THE PATENT OFFICE

CERTIFICATE OF REGISTRATION OF DESIGN

Design No. 350654-001
Date 04/10/2021 19:51:10
Reciprocity Date*
Country

Certified that the design of which a copy is annexed hereto has been registered as of the number and date given above in class 12-16 in respect of the application of such design to RACK AND PINION CASING in the name of 1.VIRAT DHOLAKIYA, SILVER OAK UNIVERSITY CAMPUS, OPP. BHAGWAT VIDYAPITH, S.G ROAD, GOTA, AHMEDABAD – 382421, INDIA 2. VATSAL SONI, SILVER OAK UNIVERSITY CAMPUS, OPP. BHAGWAT VIDYAPITH, S.G ROAD, GOTA, AHMEDABAD – 382421, INDIA

in pursuance of and subject to the provisions of the Designs Act, 2000 and the Designs Rules, 2001.

Controller General of Patents, Designs and Trade Marks

*The reciprocity date (if any) which has been allowed and the name of the country.

Copyright in the design will subsist for ten years from the date of Registration, and may under the terms of the Act and Rules, be extended for a further period of five years.

This Certificate is not for use in legal proceedings or for obtaining registration abroad

MR. DHARTI SHAH,
VERITE ASSOCIATES, 105, SCARLET GATEWAY, NR.
SPIPA ACADEMY, CORPORATE ROAD,
PRAHALADNAGR, AHMEDABAD-380015, GUJARAT,
INDIA

Date of Issue 25/01/2022 12:27:18

INTELLECTUAL
PROPERTY INDIA
PATENTS | DESIGNS | TRADE MARKS
GEOGRAPHICAL INDICATIONS

(REPRESENTATION SHEETS)

NAME OF THE APPLICANT
VIRAT DHOLAKIYA
VATSAL SONI

NO. OF SHEETS - 3
SHEET NO. - 1

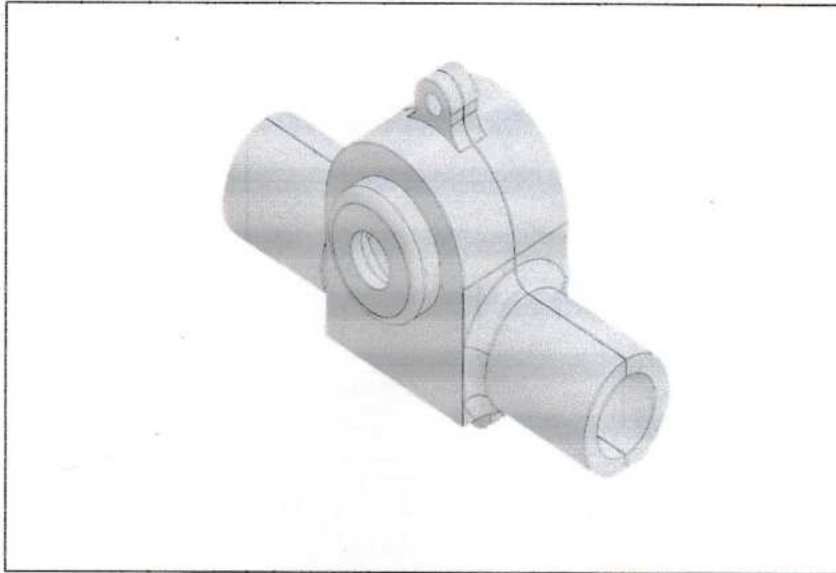

PERSPECTIVE VIEW

The novelty resides in the shape and configuration of the '**RACK AND PINION CASING**' as illustrated.

A Rack and Pinion Casing is used in all-terrain vehicle for easy assembly and compact size.

No claim is made by virtue of this registration in respect of any mechanical or other action of the mechanism whatever or in respect of any mode or principle of construction of the article.

No claim is made by virtue of the registration to any right to the exclusive use of the words, letters, numbers, colour, combination or Trade Marks as appearing in the representation.

350654-001

04 OCT 2021

Ms. DHARTI SHAH
(Authorized Agent of the Applicant)
(IN/PA- 2590)

(REPRESENTATION SHEETS)

NAME OF THE APPLICANT
VIRAT DHOLAKIYA
VATSAL SONI

NO. OF SHEETS - 3
SHEET NO. - 2

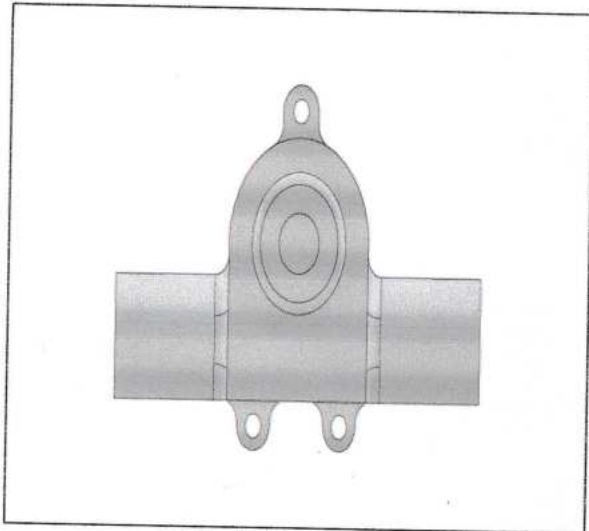

FRONT VIEW

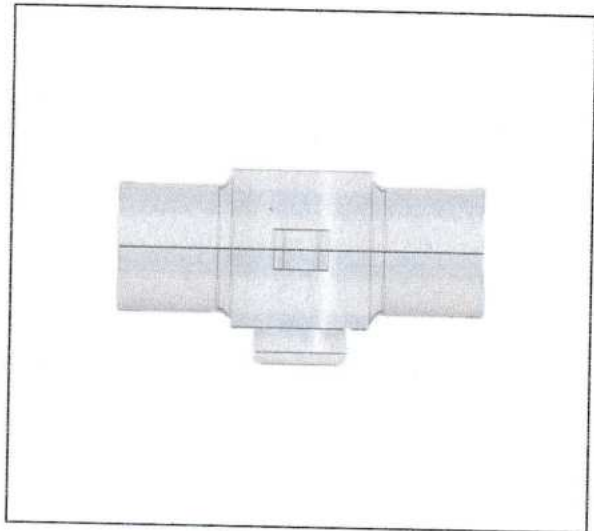

TOP VIEW

The novelty resides in the shape and configuration of the 'RACK AND PINION CASING' as illustrated.

A Rack and Pinion Casing is used in all-terrain vehicle for easy assembly and compact size.

No claim is made by virtue of this registration in respect of any mechanical or other action of the mechanism whatever or in respect of any mode or principle of construction of the article.

No claim is made by virtue of the registration to any right to the exclusive use of the words, letters, numbers, colour, combination or Trade Marks as appearing in the representation.

350654-001

04 OCT 2021



Ms. DHARTI SHAH
(Authorized Agent of the Applicant)
(IN/PA- 2590)

(REPRESENTATION SHEETS)

NAME OF THE APPLICANT
VIRAT DHOLAKIYA
VATSAL SONI

NO. OF SHEETS - 3
SHEET NO. - 3

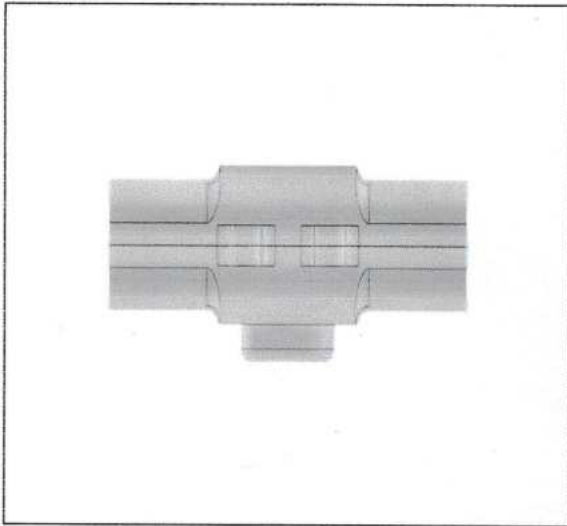

BOTTOM VIEW

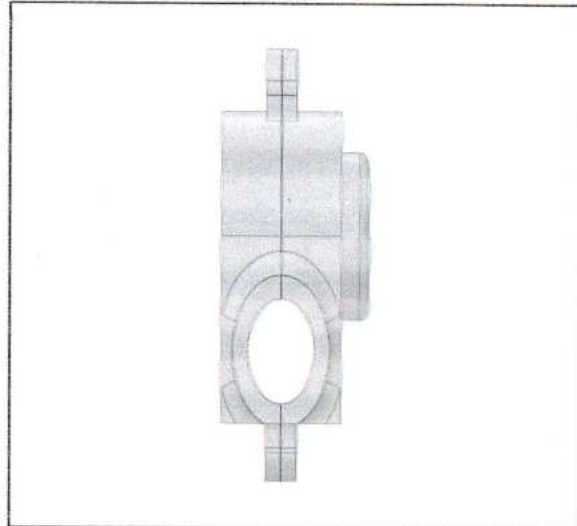

LEFT SIDE VIEW

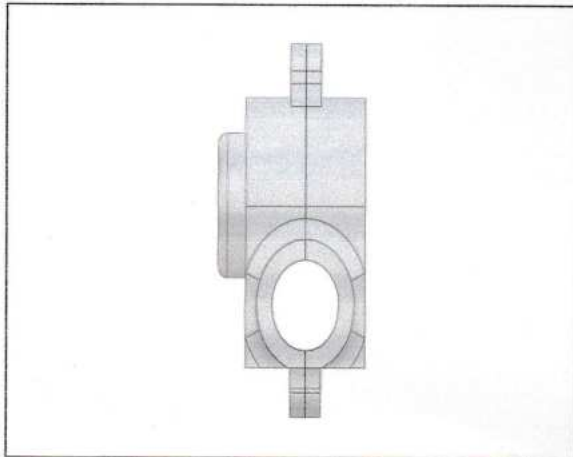

RIGHT SIDE VIEW

The novelty resides in the shape and configuration of the 'RACK AND PINION CASING' as illustrated.

A Rack and Pinion Casing is used in all-terrain vehicle for easy assembly and compact size.



No claim is made by virtue of this registration in respect of any mechanical or other action of the mechanism whatever or in respect of any mode or principle of construction of the article.

No claim is made by virtue of the registration to any right to the exclusive use of the words, letters, numbers, colour, combination or Trade Marks as appearing in the representation.

350654-001

04 OCT 2021

MS. DHARTI SHAH
(Authorized Agent of the Applicant)
(IN/PA- 2590)

DESIGN NUMBER	350654-001	
CLASS	12-16	
1.VIRAT DHOLAKIYA, SILVER OAK UNIVERSITY CAMPUS, OPP. BHAGWAT VIDYAPITH, S.G ROAD, GOTA, AHMEDABAD – 382421, INDIA 2. VATSAL SONI, SILVER OAK UNIVERSITY CAMPUS, OPP. BHAGWAT VIDYAPITH, S.G ROAD, GOTA, AHMEDABAD – 382421, INDIA		
DATE OF REGISTRATION	04/10/2021	
TITLE	RACK AND PINION CASING	
PRIORITY NA		
DESIGN NUMBER	350656-001	
CLASS	12-16	
1.VIRAT DHOLAKIYA, SILVER OAK UNIVERSITY CAMPUS, OPP. BHAGWAT VIDYAPITH, S.G ROAD, GOTA, AHMEDABAD – 382421 2. PRAKRUTI MUKUL, SILVER OAK UNIVERSITY CAMPUS, OPP. BHAGWAT VIDYAPITH, S.G ROAD, GOTA, AHMEDABAD – 382421		
DATE OF REGISTRATION	04/10/2021	
TITLE	REAR HUB INTEGRATED WITH CV	
PRIORITY NA		
DESIGN NUMBER	350719-005	
CLASS	15-09	
ENDICO POWER TOOLS (INDIA), 1266, 1268/A, 1276/1, STREETB NO.3, SHIMLAPURI, LUDHIANA- 141003, (PUNJAB), INDIA, WHOSE PARTNERS ARE MR. AVTAR SINGH, MR. JATINDER SINGH & MR. GURJEET SINGH		
DATE OF REGISTRATION	05/10/2021	
TITLE	BACKALITE PLATE FOR ROUTER MACHINE	
PRIORITY NA		



ORIGINAL

No. 105137

भारत सरकार
GOVERNMENT OF INDIA
पेटेंट कार्यालय
THE PATENT OFFICE

CERTIFICATE OF REGISTRATION OF DESIGN

Design No. 350655-001
Date 04/10/2021 19:51:10
Reciprocity Date*
Country

Certified that the design of which a copy is annexed hereto has been registered as of the number and date given above in class 12-16 in respect of the application of such design to REAR BRAKE DISC in the name of 1.VIRAT DHOLAKIYA, SILVER OAK UNIVERSITY CAMPUS, OPP. BHAGWAT VIDYAPITH, S.G ROAD, GOTA, AHMEDABAD – 382421 2. VENISH SUTHAR, SILVER OAK UNIVERSITY CAMPUS, OPP. BHAGWAT VIDYAPITH, S.G ROAD, GOTA, AHMEDABAD – 382421

in pursuance of and subject to the provisions of the Designs Act, 2000 and the Designs Rules, 2001.

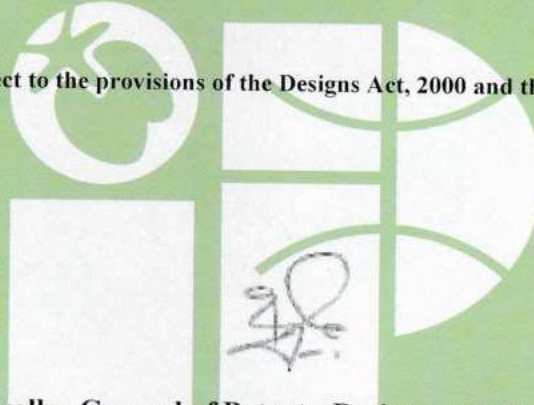

Controller General of Patents, Designs and Trade Marks

*The reciprocity date (if any) which has been allowed and the name of the country.

Copyright in the design will subsist for ten years from the date of Registration, and may under the terms of the Act and Rules, be extended for a further period of five years.

This Certificate is not for use in legal proceedings or for obtaining registration abroad

MS. DHARTI SHAH,
VERITE ASSOCIATES, 105, SCARLET GATEWAY, NR.
SPIPA ACADEMY, CORPORATE ROAD,
PRAHALADNAGR, AHMEDABAD-380015, GUJARAT,
INDIA

INTELLECTUAL
PROPERTY INDIA
PATENTS, DESIGNS | TRADE MARKS
GEOGRAPHICAL INDICATIONS

Date of Issue 23/11/2021 15:35:56

(REPRESENTATION SHEETS)

NAME OF THE APPLICANT
VIRAT DHOLAKIYA
VENISH SUTHAR

NO. OF SHEETS - 3
SHEET NO. - 1

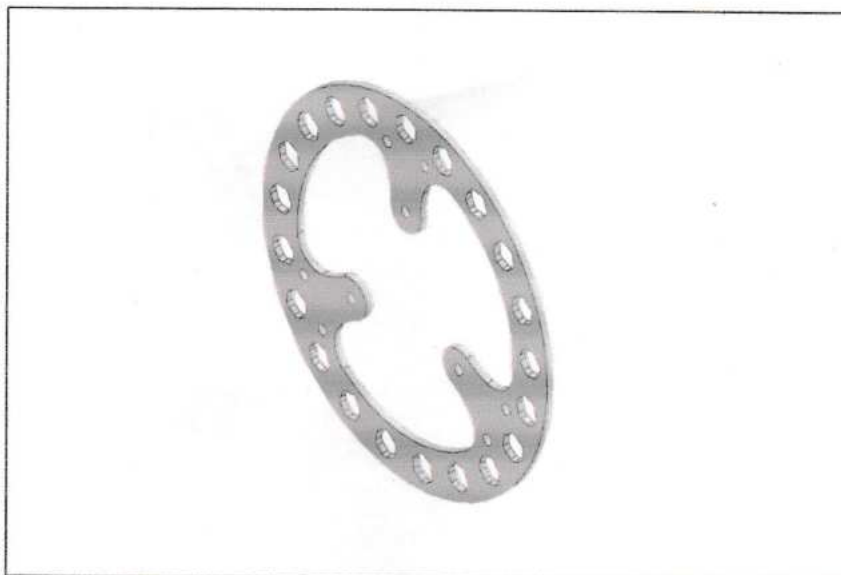

PERSPECTIVE VIEW

The novelty resides in the shape and configuration of the 'REAR BRAKE DISC' as illustrated.

A Rear Brake Disc is used in all-terrain vehicle to improve its braking performance.

No claim is made by virtue of this registration in respect of any mechanical or other action of the mechanism whatever or in respect of any mode or principle of construction of the article.

No claim is made by virtue of the registration to any right to the exclusive use of the words, letters, numbers, colour, combination or Trade Marks as appearing in the representation.

350655-001

04 OCT 2021

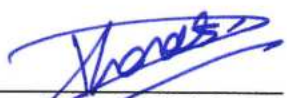
Ms. DHARTI SHAH
(Authorized Agent of the Applicant)
(IN/PA- 2590)

(REPRESENTATION SHEETS)

NAME OF THE APPLICANT
VIRAT DHOLAKIYA
VENISH SUTHAR

NO. OF SHEETS - 3
SHEET NO. - 2

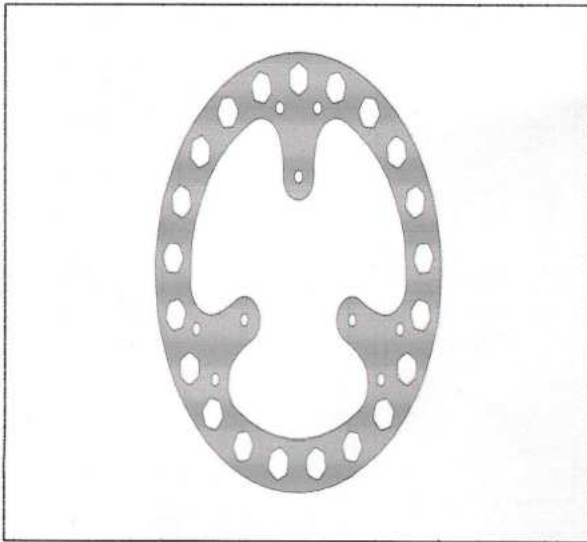

FRONT VIEW



TOP VIEW

The novelty resides in the shape and configuration of the 'REAR BRAKE DISC' as illustrated.

A Rear Brake Disc is used in all-terrain vehicle to improve its braking performance.

No claim is made by virtue of this registration in respect of any mechanical or other action of the mechanism whatever or in respect of any mode or principle of construction of the article.

No claim is made by virtue of the registration to any right to the exclusive use of the words, letters, numbers, colour, combination or Trade Marks as appearing in the representation.

350655-001
04 OCT 2021

MS. DHARTI SHAH
(Authorized Agent of the Applicant)
(IN/PA- 2590)

(REPRESENTATION SHEETS)

NAME OF THE APPLICANT
VIRAT DHOLAKIYA
VENISH SUTHAR

NO. OF SHEETS - 3
SHEET NO. - 3

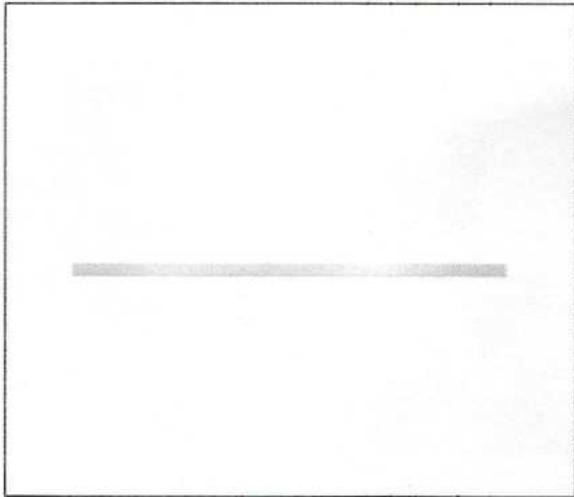

BOTTOM VIEW



LEFT SIDE VIEW



RIGHT SIDE VIEW

The novelty resides in the shape and configuration of the 'REAR BRAKE DISC' as illustrated.

A Rear Brake Disc is used in all-terrain vehicle to improve its braking performance.



No claim is made by virtue of this registration in respect of any mechanical or other action of the mechanism whatever or in respect of any mode or principle of construction of the article.

No claim is made by virtue of the registration to any right to the exclusive use of the words, letters, numbers, colour, combination or Trade Marks as appearing in the representation.

350655 - 001

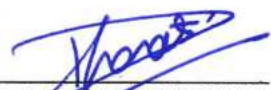
04 OCT 2021

Ms. DHARTI SHAH
(Authorized Agent of the Applicant)
(IN/PA- 2590)

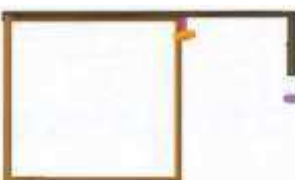
DESIGN NUMBER	350655-001	
CLASS	12-16	
1.VIRAT DHOLAKIYA, SILVER OAK UNIVERSITY CAMPUS, OPP. BHAGWAT VIDYAPITH, S.G ROAD, GOTA, AHMEDABAD – 382421 2. VENISH SUTHAR, SILVER OAK UNIVERSITY CAMPUS, OPP. BHAGWAT VIDYAPITH, S.G ROAD, GOTA, AHMEDABAD – 382421		
DATE OF REGISTRATION	04/10/2021	
TITLE	REAR BRAKE DISC	
PRIORITY NA		
DESIGN NUMBER	350662-001	
CLASS	26-03	
1.DR. POORNIMA G PATIL, DEPARTMENT OF CSE, VTU, BELAGAVI, KR 590018 2. ANOOP G L, ASSISTANT PROFESSOR, DSATM, KANAKAPURA RD, UDAYAPURA, KR 560082 3. DR. GIRISH K M, ASSISTANT PROFESSOR, DSATM, KANAKAPURA RD, UDAYAPURA, KR 560082 4. DR. JYOTI BALI, ASSISTANT PROFESSOR, DEPARTMENT OF AUTOMATION & ROBOTICS, KLE TECHNOLOGICAL UNIVERSITY, VIDYA NAGAR, HUBLI, KR 580031 , ET AL.		
DATE OF REGISTRATION	04/10/2021	
TITLE	STREET LAMP POST WITH CCTV CAMERA	
PRIORITY NA		
DESIGN NUMBER	350663-001	
CLASS	19-06	
1.DR. CHANDRASHEKHAR BADACHI, ASSO PROF, DEPARTMENT OF EEE, MSRIT, BENGALURU, KR 560054 2. RAJESHRI RAHUL ITKARKAR ASST PROF, AISSMSCOE PUNE, MH 411001 3. ABHIJEET MOHANRAO MANE CAMPUS COORDINATOR, CYP COE, KALAMBA RING ROAD, SALOKHENAGAR KOLHAPUR 416007 4. DR. VIDYA NITIN PATIL ASSO PROF, AISSMS COLLEGE OF ENGINEERING, PUNE, MH 411001 , ET AL.		
DATE OF REGISTRATION	04/10/2021	
TITLE	WRITING BOARD WITH ARRANGEMENT OF PROJECTOR AND CAMERA	
PRIORITY NA		



सत्यमेव जयते

भारत सरकार
GOVERNMENT OF INDIA
पेटेंट कार्यालय
THE PATENT OFFICE

ORIGINAL

No. 107783

CERTIFICATE OF REGISTRATION OF DESIGN

Design No. 350656-001
Date 04/10/2021 19:51:10
Reciprocity Date*
Country

Certified that the design of which a copy is annexed hereto has been registered as of the number and date given above in class 12-16 in respect of the application of such design to REAR HUB INTEGRATED WITH CV in the name of L.VIRAT DHOLAKIYA, SILVER OAK UNIVERSITY CAMPUS, OPP. BHAGWAT VIDYAPITH, S.G ROAD, GOTA, AHMEDABAD - 382421 2. PRAKRUTI MUKUL, SILVER OAK UNIVERSITY CAMPUS, OPP. BHAGWAT VIDYAPITH, S.G ROAD, GOTA, AHMEDABAD - 382421

in pursuance of and subject to the provisions of the Designs Act, 2000 and the Designs Rules, 2001.

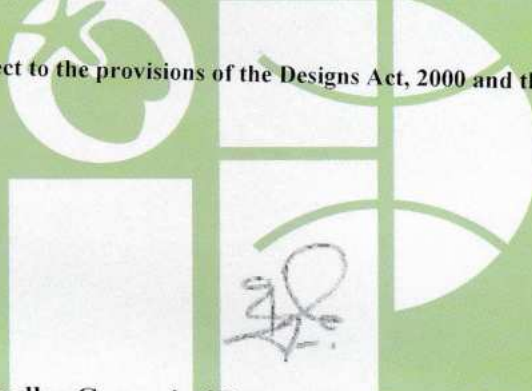

Controller General of Patents, Designs and Trade Marks

*The reciprocity date (if any) which has been allowed and the name of the country.

Copyright in the design will subsist for ten years from the date of Registration, and may under the terms of the Act and Rules, be extended for a further period of five years.

This Certificate is not for use in legal proceedings or for obtaining registration abroad

MS. DHARTI SHAH,
VERITE ASSOCIATES, 105, SCARLET GATEWAY, NR.
SPIPA ACADEMY, CORPORATE ROAD,
PRAHALADNAGR, AHMEDABAD-380015, GUJARAT,
INDIA

Date of Issue 25/01/2022 10:49:11

INTELLECTUAL
PROPERTY INDIA
PATENTS | DESIGNS | TRADE MARKS
GEOMETRICAL INDICATIONS

(REPRESENTATION SHEETS)

NAME OF THE APPLICANT
VIRAT DHOLAKIYA
PRAKRUTI MUKUL

NO. OF SHEETS - 3
SHEET NO. - 1

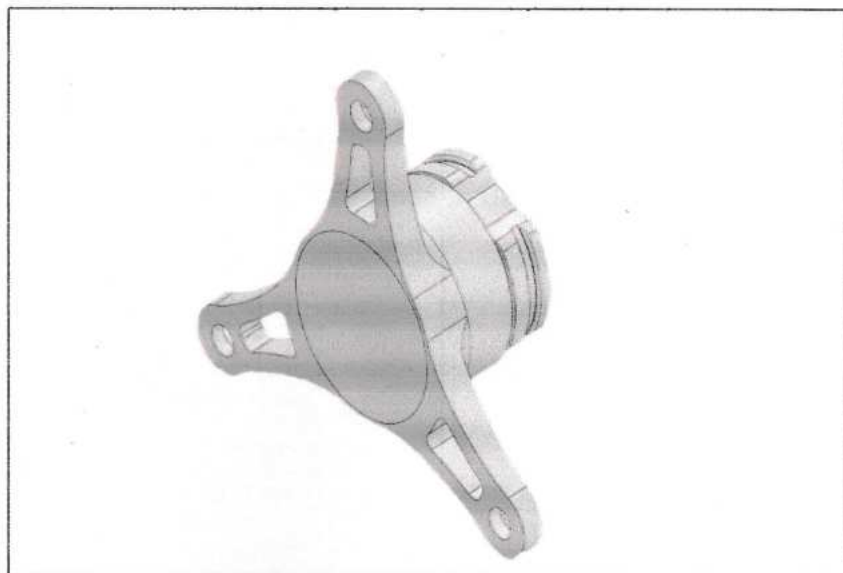

PERSPECTIVE VIEW

The novelty resides in the shape and configuration of the 'REAR HUB INTEGRATED WITH CV' as illustrated.

~~A Rear Hub integrated with CV is specially designed with two components in one assembly with lighter material for all terrain vehicles to improve its performance.~~

No claim is made by virtue of this registration in respect of any mechanical or other action of the mechanism whatever or in respect of any mode or principle of construction of the article.

No claim is made by virtue of the registration to any right to the exclusive use of the words, letters, numbers, colour, combination or Trade Marks as appearing in the representation.

350656-001

04 OCT 2021

Ms. DHARTI SHAH
(Authorized Agent of the Applicant)
(IN/PA- 2590)

(REPRESENTATION SHEETS)

NAME OF THE APPLICANT
VIRAT DHOLAKIYA
PRAKRUTI MUKUL

NO. OF SHEETS - 3
SHEET NO. - 2

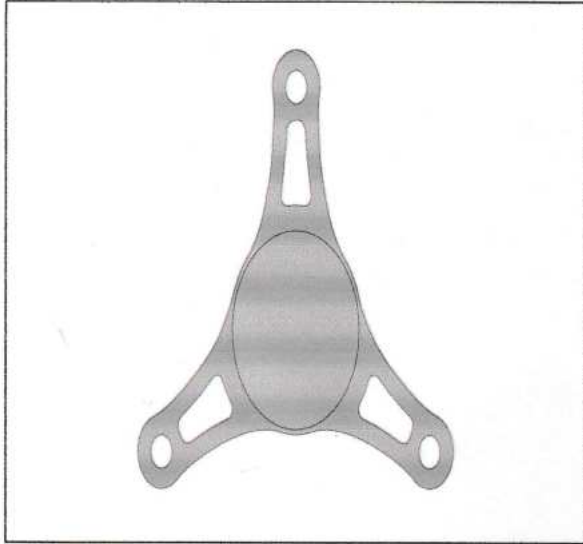

FRONT VIEW

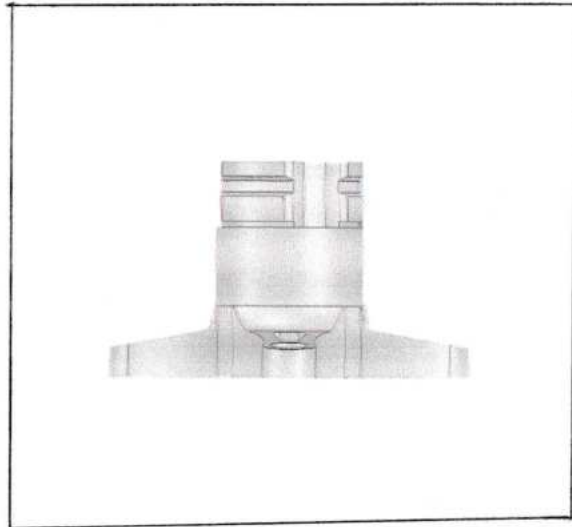

TOP VIEW

The novelty resides in the shape and configuration of the 'REAR HUB INTEGRATED WITH CV' as illustrated.

~~A Rear Hub integrated with CV is specially designed with two components in one assembly with lighter material for all terrain vehicles to improve its performance.~~

No claim is made by virtue of this registration in respect of any mechanical or other action of the mechanism whatever or in respect of any mode or principle of construction of the article.

No claim is made by virtue of the registration to any right to the exclusive use of the words, letters, numbers, colour, combination or Trade Marks as appearing in the representation.

350656-001

04 OCT 2021



Ms. DHARTI SHAH
(Authorized Agent of the Applicant)
(IN/PA- 2590)

(REPRESENTATION SHEETS)

NAME OF THE APPLICANT
VIRAT DHOLAKIYA
PRAKRUTI MUKUL

NO. OF SHEETS - 3
SHEET NO. - 3

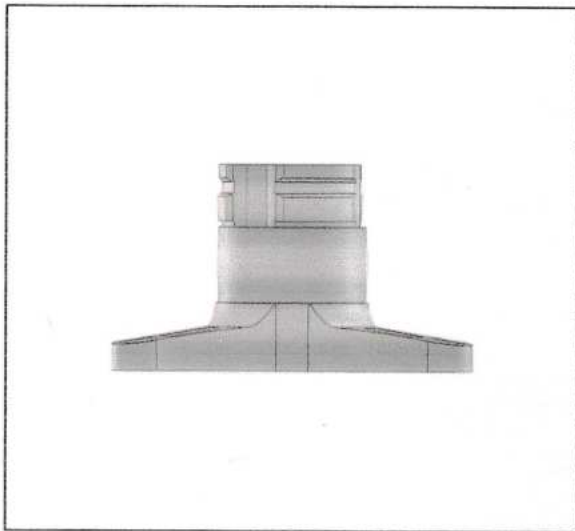

BOTTOM VIEW

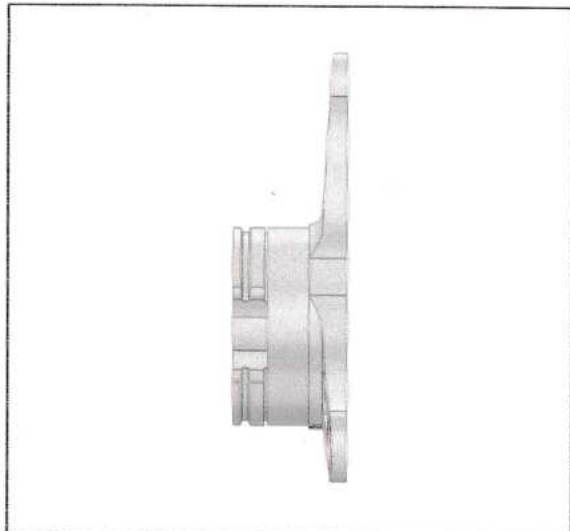

LEFT SIDE VIEW

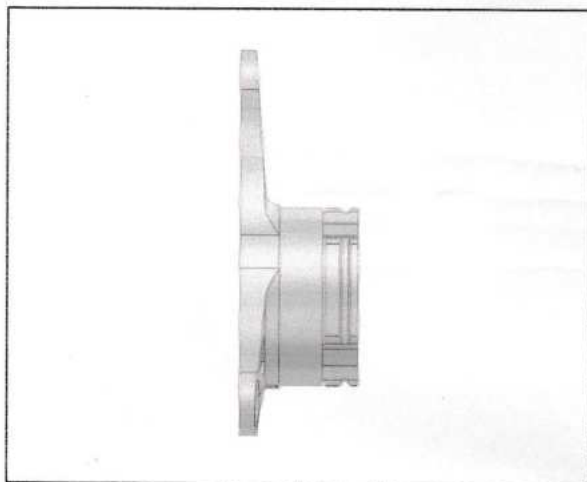

RIGHT SIDE VIEW

The novelty resides in the shape and configuration of the '**REAR HUB INTEGRATED WITH CV**' as illustrated.



~~A Rear Hub integrated with CV is specially designed with two components in one assembly with lighter material for all terrain vehicles to improve its performance.~~

No claim is made by virtue of this registration in respect of any mechanical or other action of the mechanism whatever or in respect of any mode or principle of construction of the article.

No claim is made by virtue of the registration to any right to the exclusive use of the words, letters, numbers, colour, combination or Trade Marks as appearing in the representation.

350656 - 001
04 OCT 2021

Ms. DHARTI SHAH
(Authorized Agent of the Applicant)
(IN/PA- 2590)

DESIGN NUMBER	350654-001	
CLASS	12-16	
1.VIRAT DHOLAKIYA, SILVER OAK UNIVERSITY CAMPUS, OPP. BHAGWAT VIDYAPITH, S.G ROAD, GOTA, AHMEDABAD – 382421, INDIA 2. VATSAL SONI, SILVER OAK UNIVERSITY CAMPUS, OPP. BHAGWAT VIDYAPITH, S.G ROAD, GOTA, AHMEDABAD – 382421, INDIA		
DATE OF REGISTRATION	04/10/2021	
TITLE	RACK AND PINION CASING	
PRIORITY NA		
DESIGN NUMBER	350656-001	
CLASS	12-16	
1.VIRAT DHOLAKIYA, SILVER OAK UNIVERSITY CAMPUS, OPP. BHAGWAT VIDYAPITH, S.G ROAD, GOTA, AHMEDABAD – 382421 2. PRAKRUTI MUKUL, SILVER OAK UNIVERSITY CAMPUS, OPP. BHAGWAT VIDYAPITH, S.G ROAD, GOTA, AHMEDABAD – 382421		
DATE OF REGISTRATION	04/10/2021	
TITLE	REAR HUB INTEGRATED WITH CV	
PRIORITY NA		
DESIGN NUMBER	350719-005	
CLASS	15-09	
ENDICO POWER TOOLS (INDIA), 1266, 1268/A, 1276/1, STREETB NO.3, SHIMLAPURI, LUDHIANA- 141003, (PUNJAB), INDIA, WHOSE PARTNERS ARE MR. AVTAR SINGH, MR. JATINDER SINGH & MR. GURJEET SINGH		
DATE OF REGISTRATION	05/10/2021	
TITLE	BACKALITE PLATE FOR ROUTER MACHINE	
PRIORITY NA		

ORIGINAL

No. 109918



भारत सरकार
GOVERNMENT OF INDIA
पेटेंट कार्यालय
THE PATENT OFFICE

CERTIFICATE OF REGISTRATION OF DESIGN

Design No. 356371-001
Date 08/01/2022 17:05:37
Reciprocity Date*
Country

Certified that the design of which a copy is annexed hereto has been registered as of the number and date given above in class 29-02 in respect of the application of such design to MASK EAR PROTECTOR – MASKER in the name of I.KEVAL KELAWALA, SILVER OAK UNIVERSITY CAMPUS, OPP. BHAGWAT VIDYAPITH, S.G ROAD, GOTA, AHMEDABAD – 382421, INDIA 2. SHIVAM JANI, SILVER OAK UNIVERSITY CAMPUS, OPP. BHAGWAT VIDYAPITH, S.G ROAD, GOTA, AHMEDABAD – 382421

in pursuance of and subject to the provisions of the Designs Act, 2000 and the Designs Rules, 2001.

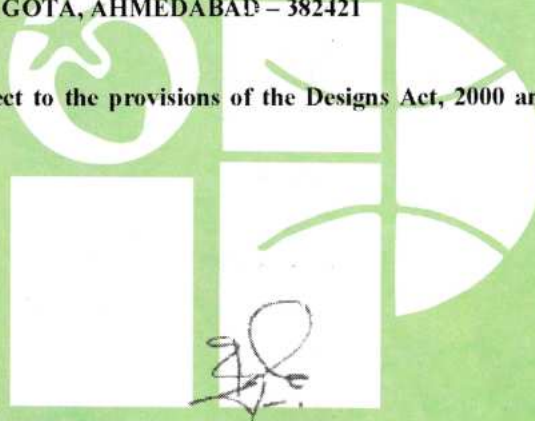

Controller General of Patents, Designs and Trade Marks

*The reciprocity date (if any) which has been allowed and the name of the country.

Copyright in the design will subsist for ten years from the date of Registration, and may under the terms of the Act and Rules, be extended for a further period of five years.

This Certificate is not for use in legal proceedings or for obtaining registration abroad

MS. DHARTI SHAH,
VERITE ASSOCIATES, 105, SCARLET GATEWAY,
NR. SPIPA ACADEMY, CORPORATE ROAD,
PRAHALADNAGR, AHMEDABAD-380015,
GUJARAT, INDIA

Date of Issue 08/03/2022 12:55:10

INTELLECTUAL
PROPERTY INDIA
PATENTS | DESIGNS | TRADE MARKS
GEOGRAPHICAL INDICATIONS

(REPRESENTATION SHEETS)

NAME OF THE APPLICANT
KEVAL KELAWALA
SHIVAM JANI

NO. OF SHEETS - 3
SHEET NO. - 1

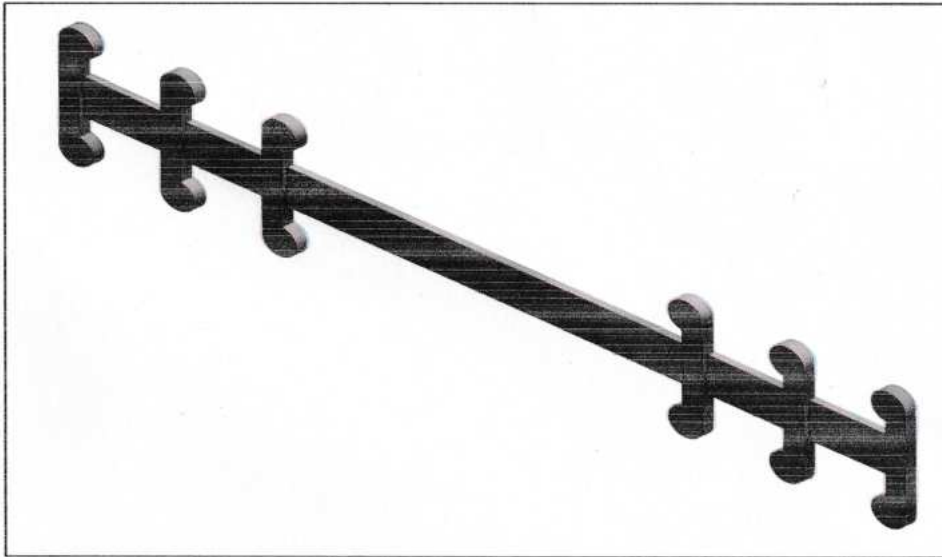

PERSPECTIVE VIEW

The novelty resides in the shape and configuration of the 'MASK EAR PROTECTOR – MaskER' as illustrated.

No claim is made by virtue of this registration in respect of any mechanical or other action of the mechanism whatever or in respect of any mode or principle of construction of the article.

No claim is made by virtue of the registration to any right to the exclusive use of the words, letters, numbers, colour, combination or Trade Marks as appearing in the representation.

356371-001
08 JAN 2022

Dated this 8th day January of 2022.

Ms. DHARTI SHAH
(Authorized Agent of the Applicant)
(IN/PA- 2590)

(REPRESENTATION SHEETS)

NAME OF THE APPLICANT
KEVAL KELAWALA
SHIVAM JANI

NO. OF SHEETS - 3
SHEET NO. - 2

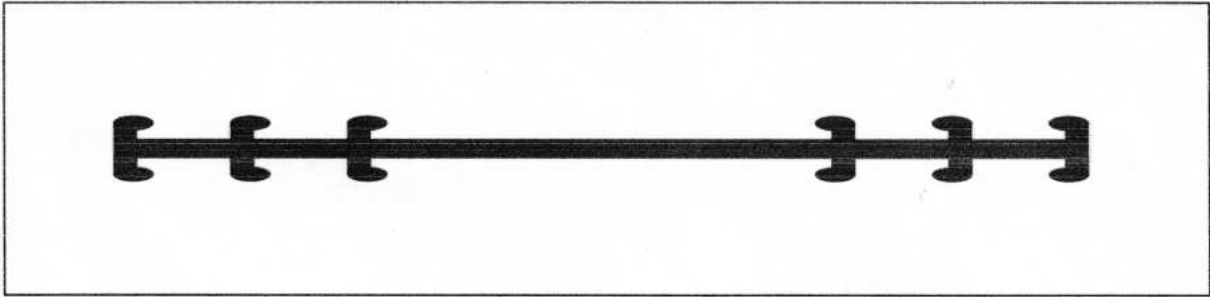

FRONT VIEW

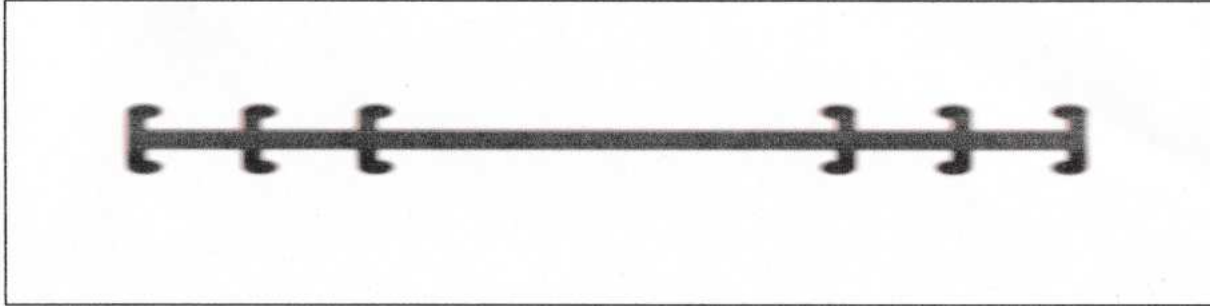

BACK VIEW

The novelty resides in the shape and configuration of the 'MASK EAR PROTECTOR - MaskER' as illustrated.

No claim is made by virtue of this registration in respect of any mechanical or other action of the mechanism whatever or in respect of any mode or principle of construction of the article.

No claim is made by virtue of the registration to any right to the exclusive use of the words, letters, numbers, colour, combination or Trade Marks as appearing in the representation.

Dated this 8th day January of 2022.

356371-001
08 JAN 2022

Ms. DHARTI SHAH
(Authorized Agent of the Applicant)
(IN/PA- 2590)

(REPRESENTATION SHEETS)

NAME OF THE APPLICANT
KEVAL KELAWALA
SHIVAM JANI

NO. OF SHEETS - 3
SHEET NO. - 3

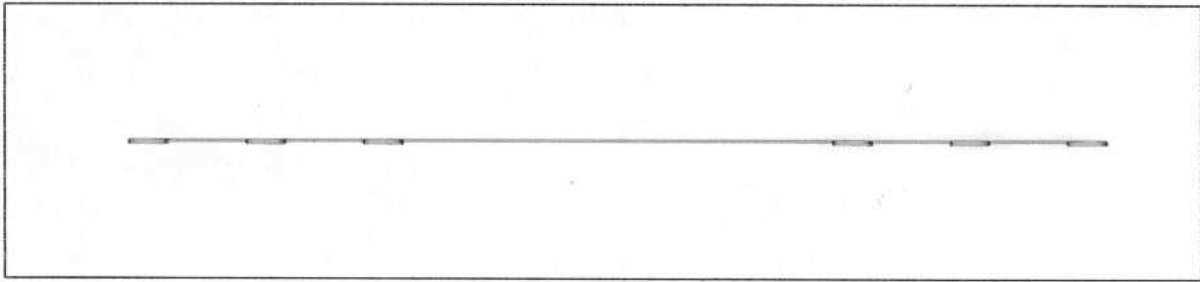

TOP VIEW

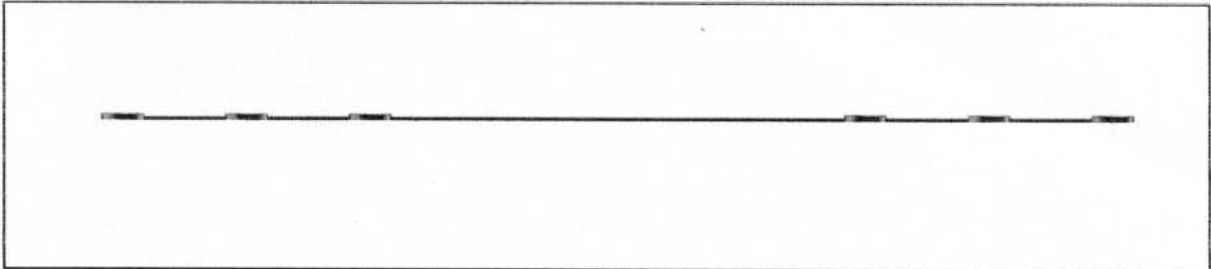

BOTTOM VIEW

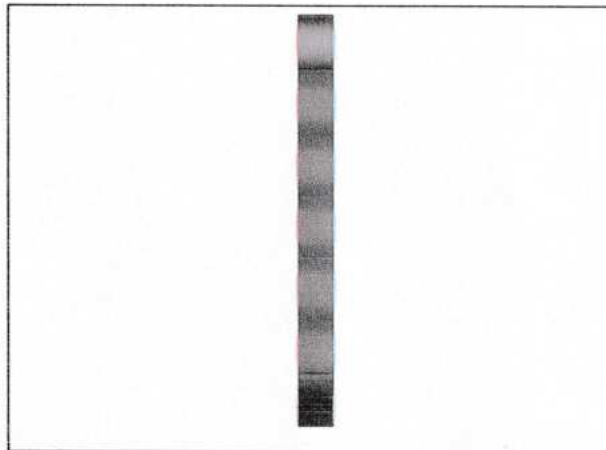

SIDE VIEW

The novelty resides in the shape and configuration of the 'MASK EAR PROTECTOR - MaskER' as illustrated.

No claim is made by virtue of this registration in respect of any mechanical or other action of the mechanism whatever or in respect of any mode or principle of construction of the article.



No claim is made by virtue of the registration to any right to the exclusive use of the words, letters, numbers, colour, combination or Trade Marks as appearing in the representation.

356371-001

08 JAN 2022

Dated this 8th day January of 2022.

MS. DHARTI SHAH
(Authorized Agent of the Applicant)
(IN/PA- 2590)

DESIGN NUMBER	356371-001		
CLASS	29-02		
1. KEVAL KELAWALA SILVER OAK UNIVERSITY CAMPUS, OPP. BHAGWAT VIDYAPITH, S.G ROAD, GOTA, AHMEDABAD – 382421, INDIA 2. SHIVAM JANI SILVER OAK UNIVERSITY CAMPUS, OPP. BHAGWAT VIDYAPITH, S.G ROAD, GOTA, AHMEDABAD – 382421			
DATE OF REGISTRATION	08/01/2022		
TITLE	MASK EAR PROTECTOR – MASKER		
PRIORITY NA			
DESIGN NUMBER	356414-001		
CLASS	14-06		
CHANGLAI GUO UNIT 1, BUILDING 1, OR UNIT 2, BUILDING 4, NO. 29 DONGFENG ROAD, DEZHOU CITY, SHANDONG PROVINCE POSTAL CODE:253000			
DATE OF REGISTRATION	10/01/2022		
TITLE	DESKTOP STAND FOR MOBILE TELEPHONE		
PRIORITY			
PRIORITY NUMBER	DATE	COUNTRY	
202130436775.4	10/07/2021	CHINA	
DESIGN NUMBER	356424-001		
CLASS	10-05		
DR GANESH VIJAYKUMAR JADHAV DEPARTMENT OF ENGLISH DHANANJAYRAO GADGIL COLLEGE OF COMMERCE A/P SATATA DIST SATARA 415001 MAHARASHTRA			
DATE OF REGISTRATION	10/01/2022		
TITLE	LONELINESS DETECTING DEVICE		
PRIORITY NA			



ORIGINAL

No. 110637

भारत सरकार
GOVERNMENT OF INDIA
पेटेंट कार्यालय
THE PATENT OFFICE

CERTIFICATE OF REGISTRATION OF DESIGN

Design No. 356372-001
Date 08/01/2022 17:05:37
Reciprocity Date*
Country

Certified that the design of which a copy is annexed hereto has been registered as of the number and date given above in class 08-99 in respect of the application of such design to HANDLE in the name of 1.KEVAL KELAWALA, SILVER OAK UNIVERSITY CAMPUS, OPP. BHAGWAT VIDYAPITH, S.G ROAD, GOTA, AHMEDABAD - 382421, INDIA 2. SHIVAM JANI, SILVER OAK UNIVERSITY CAMPUS, OPP. BHAGWAT VIDYAPITH, S.G ROAD, GOTA, AHMEDABAD - 382421, INDIA

in pursuance of and subject to the provisions of the Designs Act, 2000 and the Designs Rules, 2001.

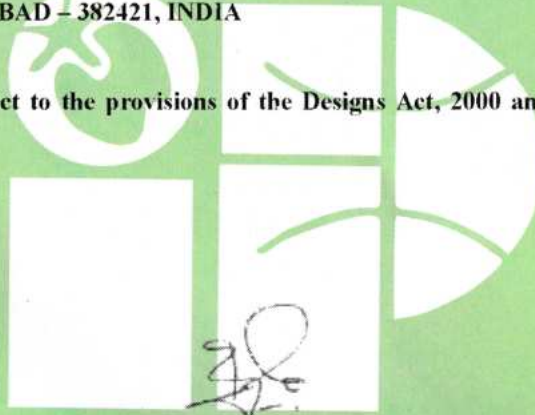

Controller General of Patents, Designs and Trade Marks

*The reciprocity date (if any) which has been allowed and the name of the country.

Copyright in the design will subsist for ten years from the date of Registration, and may under the terms of the Act and Rules, be extended for a further period of five years.

This Certificate is not for use in legal proceedings or for obtaining registration abroad

MS. DHARTI SHAH,
VERITE ASSOCIATES, 105, SCARLET GATEWAY,
NR. SPIPA ACADEMY, CORPORATE ROAD,
PRAHALADNAGR, AHMEDABAD-380015,
GUJARAT, INDIA

Date of Issue 21/03/2022 16:18:54

INTELLECTUAL
PROPERTY INDIA
PATENTS | DESIGNS | TRADE MARKS
GEOGRAPHICAL INDICATIONS

(REPRESENTATION SHEETS)

NAME OF THE APPLICANT
KEVAL KELAWALA
SHIVAM JANI

NO. OF SHEETS - 3
SHEET NO. - 1

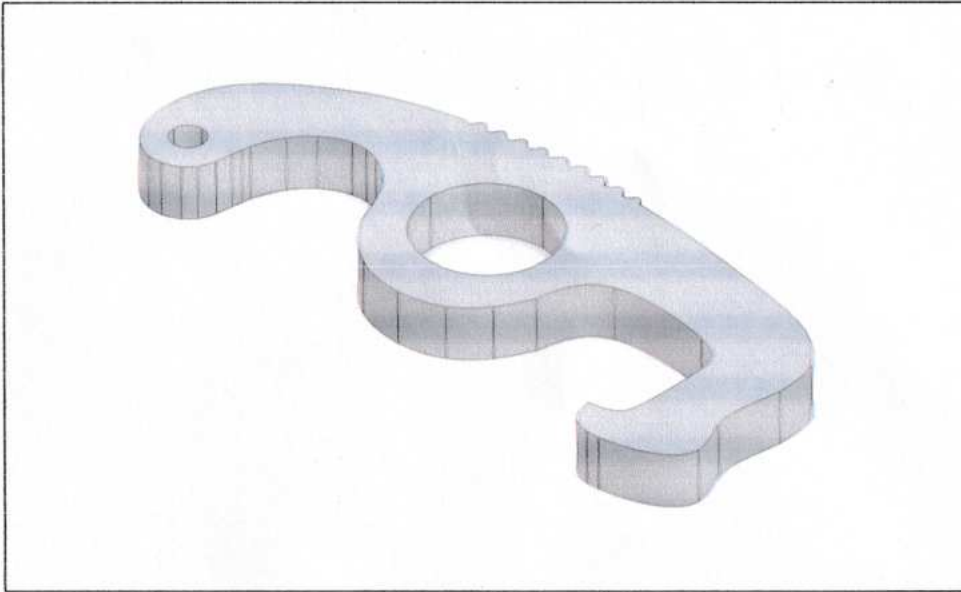

PERSPECTIVE VIEW

The novelty resides in the shape and configuration of the 'HANDLE' as illustrated.

No claim is made by virtue of this registration in respect of any mechanical or other action of the mechanism whatever or in respect of any mode or principle of construction of the article.

No claim is made by virtue of the registration to any right to the exclusive use of the words, letters, numbers, colour, combination or Trade Marks as appearing in the representation.

Dated this 8th day January of 2022.

356372-001 (Authorized Agent of the Applicant)
08 JAN 2022

Ms. DHARTI SHAH
(IN/PA- 2590)

(REPRESENTATION SHEETS)

NAME OF THE APPLICANT
KEVAL KELAWALA
SHIVAM JANI

NO. OF SHEETS - 3
SHEET NO. - 2

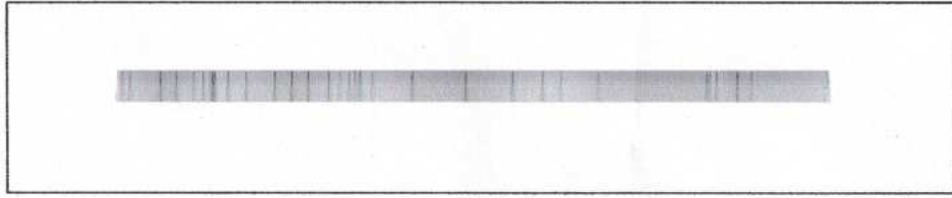

FRONT VIEW

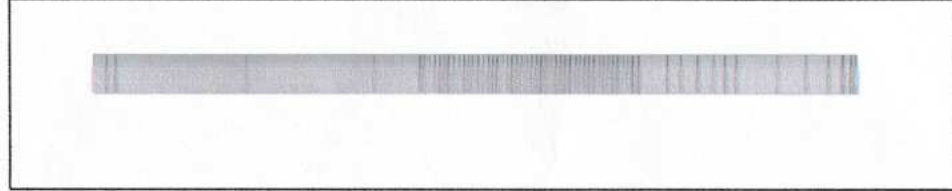

BACK VIEW

The novelty resides in the shape and configuration of the 'HANDLE' as illustrated.

No claim is made by virtue of this registration in respect of any mechanical or other action of the mechanism whatever or in respect of any mode or principle of construction of the article.

No claim is made by virtue of the registration to any right to the exclusive use of the words, letters, numbers, colour, combination or Trade Marks as appearing in the representation.

Dated this 8th day January of 2022.



Ms. DHARTI SHAH

(Authorized Agent of the Applicant)

(IN/PA- 2590)

356372 -001

08 JAN 2022

(REPRESENTATION SHEETS)

NAME OF THE APPLICANT
KEVAL KELAWALA
SHIVAM JANI

NO. OF SHEETS - 3
SHEET NO. - 3

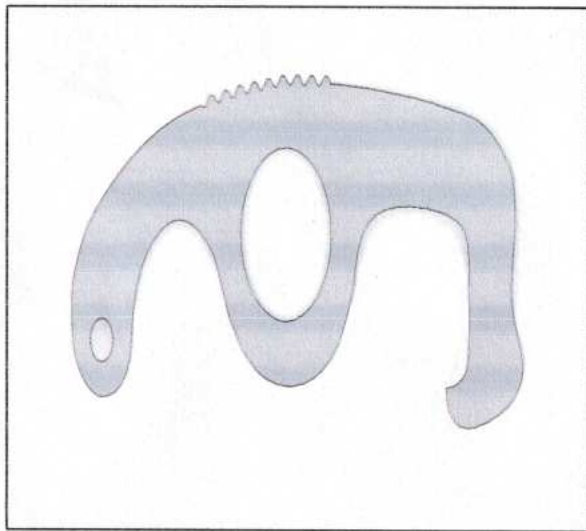

TOP VIEW

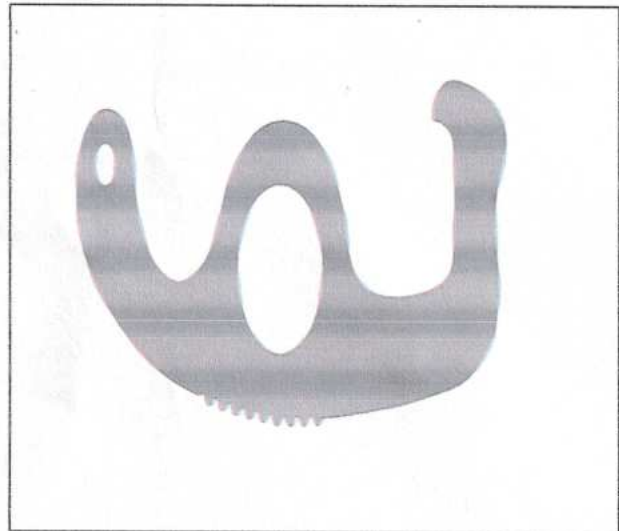

BOTTOM VIEW

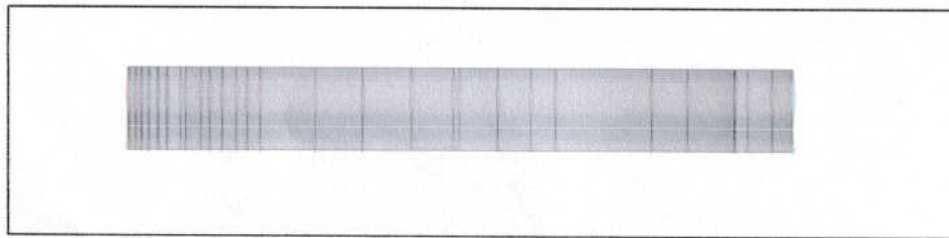

SIDE VIEW

The novelty resides in the shape and configuration of the 'HANDLE' as illustrated.

No claim is made by virtue of this registration in respect of any mechanical or other action of the mechanism whatever or in respect of any mode or principle of construction of the article.



No claim is made by virtue of the registration to any right to the exclusive use of the words, letters, numbers, colour, combination or Trade Marks as appearing in the representation.

Dated this 8th day January of 2022. 356372-001

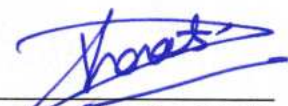
08 JAN 2022

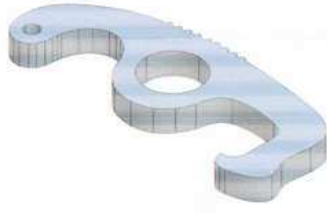

Ms. DHARTI SHAH
(Authorized Agent of the Applicant)
(IN/PA- 2590)

DESIGN NUMBER	356302-001	
CLASS	08-07	
ROHIT MOHAN SHARMA YASH ENTERPRISES 1/98 B-1, SANJAY GANDHI COLONY RAVAN TEELA ALIGARB-202001		
DATE OF REGISTRATION	06/01/2022	
TITLE	FOUR DEAD BOLT WITH ONE LATCH FOR DOOR LOCKING	
PRIORITY NA		
DESIGN NUMBER	356311-001	
CLASS	10-07	
HARDIK RAMJIBHAI ASODARIYA C-1004, SAIPOOJA RESIDENCY, B/H OPERA CITY, UTRAN, SURAT- 394105, INDIA		
DATE OF REGISTRATION	07/01/2022	
TITLE	WATCH DIAL	
PRIORITY NA		
DESIGN NUMBER	356372-001	
CLASS	08-99	
1.KEVAL KELAWALA SILVER OAK UNIVERSITY CAMPUS, OPP. BHAGWAT VIDYAPITH, S.G ROAD, GOTA, AHMEDABAD – 382421, INDIA 2. SHIVAM JANI SILVER OAK UNIVERSITY CAMPUS, OPP. BHAGWAT VIDYAPITH, S.G ROAD, GOTA, AHMEDABAD – 382421, INDIA		
DATE OF REGISTRATION	08/01/2022	
TITLE	HANDLE	
PRIORITY NA		



ORIGINAL

No. 104576

भारत सरकार
GOVERNMENT OF INDIA
पेटेंट कार्यालय
THE PATENT OFFICE

CERTIFICATE OF REGISTRATION OF DESIGN

Design No. 348967-001
Date 06/09/2021 17:02:25
Reciprocity Date*
Country

Certified that the design of which a copy is annexed hereto has been registered as of the number and date given above in class 12-16 in respect of the application of such design to FRONT HUB in the name of 1.VIRAJ PANCHAL, SILVER OAK UNIVERSITY CAMPUS, OPP. BHAGWAT VIDYAPITH, S.G ROAD, GOTA, AHMEDABAD - 382421, INDIA 2. BHAVDEEP TRIVEDI SILVER OAK UNIVERSITY CAMPUS, OPP. BHAGWAT VIDYAPITH, S.G ROAD, GOTA, AHMEDABAD - 382421

in pursuance of and subject to the provisions of the Designs Act, 2000 and the Designs Rules, 2001.

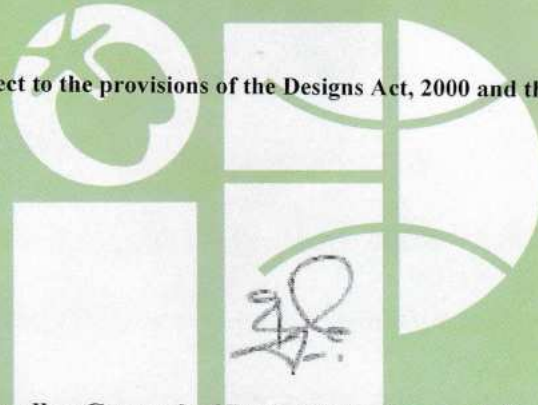

Controller General of Patents, Designs and Trade Marks

*The reciprocity date (if any) which has been allowed and the name of the country.

Copyright in the design will subsist for ten years from the date of Registration, and may under the terms of the Act and Rules, be extended for a further period of five years.

This Certificate is not for use in legal proceedings or for obtaining registration abroad

MS. DHARTI SHAH,
VERITE ASSOCIATES, 105, SCARLET GATEWAY, NR.
SPIPA ACADEMY, CORPORATE ROAD,
PRAHALADNAGR, AHMEDABAD-380015, GUJARAT,
INDIA

Date of Issue 10/11/2021 14:43:25

(REPRESENTATION SHEETS)

Name of the Applicant

Viraj Panchal

Bhavdeep Trivedi

No. of Sheets - 3

Sheet No. - 1



PERSPECTIVE VIEW

The novelty resides in the shape and configuration of the 'FRONT HUB' as illustrated.

~~A Front Wheel Hub is used for all-terrain vehicle with lighter material to improve its performance.~~

No claim is made by virtue of this registration in respect of any mechanical or other action of the mechanism whatever or in respect of any mode or principle of construction of the article.

No claim is made by virtue of the registration to any right to the exclusive use of the words, letters, numbers, colour, combination or Trade Marks as appearing in the representation.

348967-001
06 SEP 2021

Ms. DHARTI SHAH
(Authorized Agent of the Applicant)
(IN/PA- 2590)

(REPRESENTATION SHEETS)

Name of the Applicant

Viraj Panchal
Bhavdeep Trivedi

No. of Sheets – 3

Sheet No. - 2



FRONT VIEW

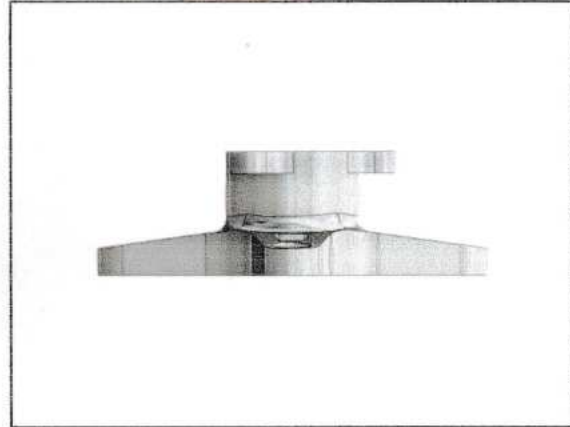

TOP VIEW

The novelty resides in the shape and configuration of the 'FRONT HUB' as illustrated.

A Front Wheel Hub is used for all-terrain vehicle with lighter material to improve its performance.

No claim is made by virtue of this registration in respect of any mechanical or other action of the mechanism whatever or in respect of any mode or principle of construction of the article.

No claim is made by virtue of the registration to any right to the exclusive use of the words, letters, numbers, colour, combination or Trade Marks as appearing in the representation.

348967-001
06 SEP 2021

Ms. DHARTI SHAH
(Authorized Agent of the Applicant)
(IN/PA- 2590)

(REPRESENTATION SHEETS)

Name of the Applicant

Viraj Panchal
Bhavdeep Trivedi

No. of Sheets - 3

Sheet No. - 3

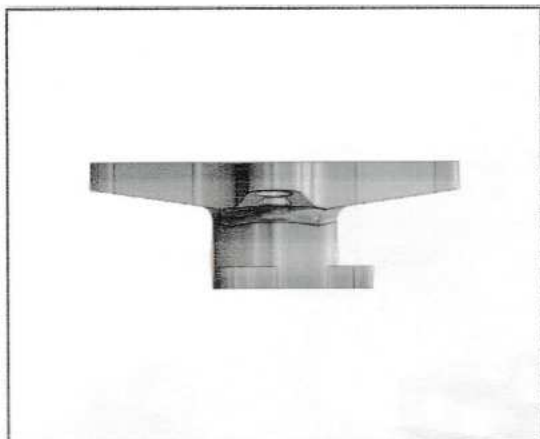

BOTTOM VIEW



LEFT SIDE VIEW



RIGHT SIDE VIEW

The novelty resides in the shape and configuration of the 'FRONT HUB' as illustrated.

~~A Front Wheel Hub is used for all-terrain vehicle with lighter material to improve its performance.~~

No claim is made by virtue of this registration in respect of any mechanical or other action of the mechanism whatever or in respect of any mode or principle of construction of the article.

No claim is made by virtue of the registration to any right to the exclusive use of the words, letters, numbers, colour, combination or Trade Marks as appearing in the representation.

348987-001

06 SEP 2021

Ms. DHARTI SHAH
(Authorized Agent of the Applicant)
(IN/PA- 2590)

DESIGN NUMBER	335687-001	
CLASS	02-01	
KINSHU JAIN, 4-B, HEEDA KI MORI, GURUDWARA, GALTA ROAD, JAIPUR (RAJ.)- 302003		
DATE OF REGISTRATION	29/11/2020	
TITLE	NIGHTY WITH ROBE SET	
PRIORITY NA		
DESIGN NUMBER	338588-001	
CLASS	02-02	
NIKUNJ VINUBHAI SAVANI, E-2, 404, ABHISHEK RESIDENCY-1, SUDAMA CHOWK, MOTA VARACHHA, SURAT, GUJARAT		
DATE OF REGISTRATION	04/02/2021	
TITLE	LADIES GARMENT SET	
PRIORITY NA		
DESIGN NUMBER	348967-001	
CLASS	12-16	
1. VIRAJ PANCHAL, SILVER OAK UNIVERSITY CAMPUS, OPP. BHAGWAT VIDYAPITH, S.G ROAD, GOTA, AHMEDABAD - 382421, INDIA 2. BHAVDEEP TRIVEDI SILVER OAK UNIVERSITY CAMPUS, OPP. BHAGWAT VIDYAPITH, S.G ROAD, GOTA, AHMEDABAD - 382421		
DATE OF REGISTRATION	06/09/2021	
TITLE	FRONT HUB	
PRIORITY NA		



ORIGINAL

No. **104400**

भारत सरकार
GOVERNMENT OF INDIA
पेटेंट कार्यालय
THE PATENT OFFICE

CERTIFICATE OF REGISTRATION OF DESIGN

Design No. 348965-001
Date 06/09/2021 17:02:25
Reciprocity Date*
Country

Certified that the design of which a copy is annexed hereto has been registered as of the number and date given above in class 12-16 in respect of the application of such design to STEERING CASING in the name of 1.VENISH SUTHAR, SILVER OAK UNIVERSITY CAMPUS, OPP. BHAGWAT VIDYAPITH, S.G ROAD, GOTA, AHMEDABAD - 382421 2. RUTVIK SUTHAR, SILVER OAK UNIVERSITY CAMPUS, OPP. BHAGWAT VIDYAPITH, S.G ROAD, GOTA, AHMEDABAD - 382421

in pursuance of and subject to the provisions of the Designs Act, 2000 and the Designs Rules, 2001.

Controller General of Patents, Designs and Trade Marks

*The reciprocity date (if any) which has been allowed and the name of the country.

Copyright in the design will subsist for ten years from the date of Registration, and may under the terms of the Act and Rules, be extended for a further period of five years.

This Certificate is not for use in legal proceedings or for obtaining registration abroad

MS. DHARTI SHAH,
VERITE ASSOCIATES, 105, SCARLET GATEWAY, NR.
SPIPA ACADEMY, CORPORATE ROAD,
PRAHALADNAGR, AHMEDABAD-380015, GUJARAT,
INDIA

Date of Issue 08/11/2021 15:46:27

INTELLECTUAL
PROPERTY INDIA

DESIGNS | TRADE MARKS
GEOGRAPHICAL INDICATIONS

(REPRESENTATION SHEETS)

Name of the Applicant
Venish Suthar
Rutvik Suthar

No. of Sheets - 3
Sheet No. - 1

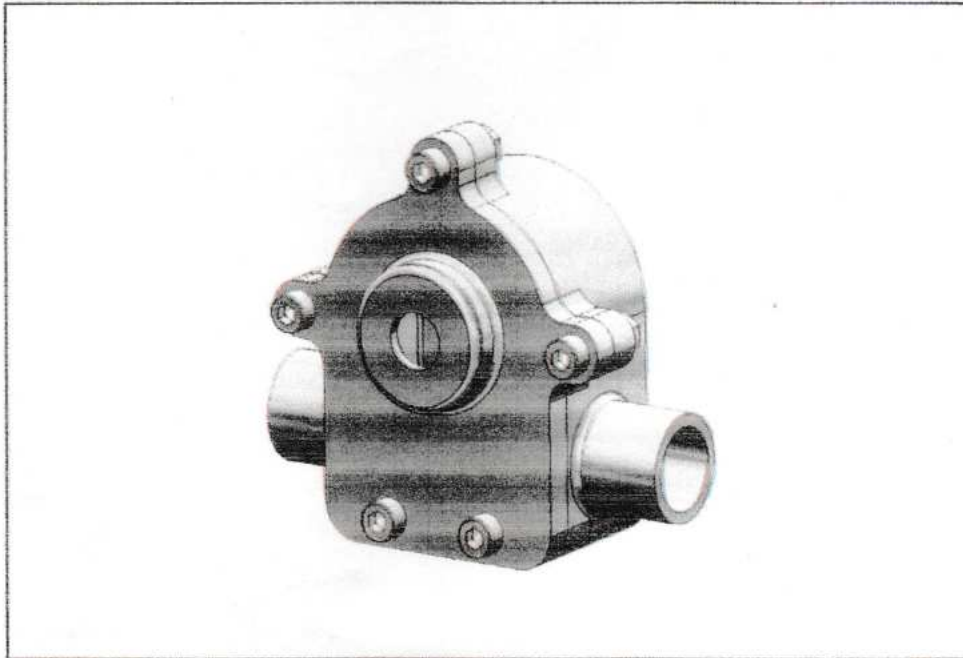

PERSPECTIVE VIEW

The novelty resides in the shape and configuration of the '**STEERING CASING**' as illustrated.

A Steering casing is used in all-terrain vehicle for easy assembly and compact size.

No claim is made by virtue of this registration in respect of any mechanical or other action of the mechanism whatever or in respect of any mode or principle of construction of the article.

No claim is made by virtue of the registration to any right to the exclusive use of the words, letters, numbers, colour, combination or Trade Marks as appearing in the representation.

348965-001
06 SEP 2021

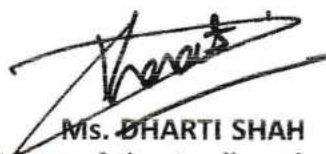
Ms. DHARTI SHAH
(Authorized Agent of the Applicant)
(IN/PA- 2590)

(REPRESENTATION SHEETS)

Name of the Applicant
Venish Suthar
Rutvik Suthar

No. of Sheets – 3
Sheet No. - 2

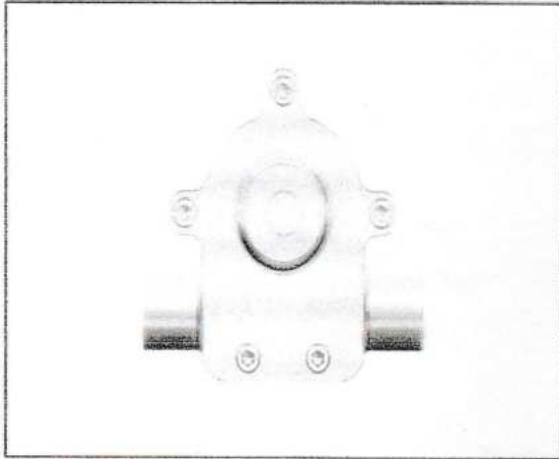

FRONT VIEW

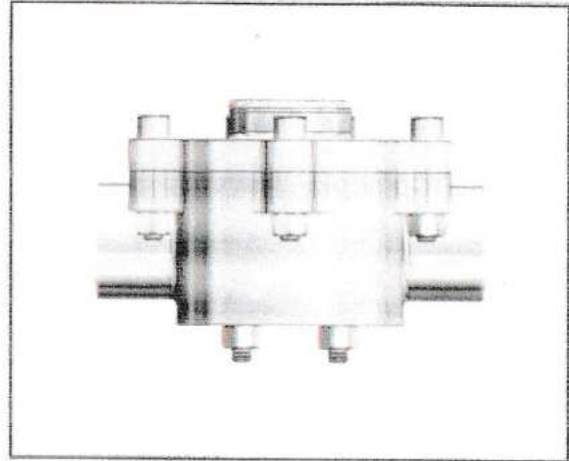

TOP VIEW

The novelty resides in the shape and configuration of the 'STEERING CASING' as illustrated.

A Steering casing is used in all-terrain vehicle for easy assembly and compact size.

No claim is made by virtue of this registration in respect of any mechanical or other action of the mechanism whatever or in respect of any mode or principle of construction of the article.

No claim is made by virtue of the registration to any right to the exclusive use of the words, letters, numbers, colour, combination or Trade Marks as appearing in the representation.

348965-001
06 SEP 2021

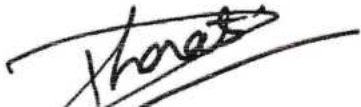
Ms. DHARTI SHAH
(Authorized Agent of the Applicant)
(IN/PA- 2590)

(REPRESENTATION SHEETS)

Name of the Applicant
Venish Suthar
Rutvik Suthar

No. of Sheets - 3
Sheet No. - 3

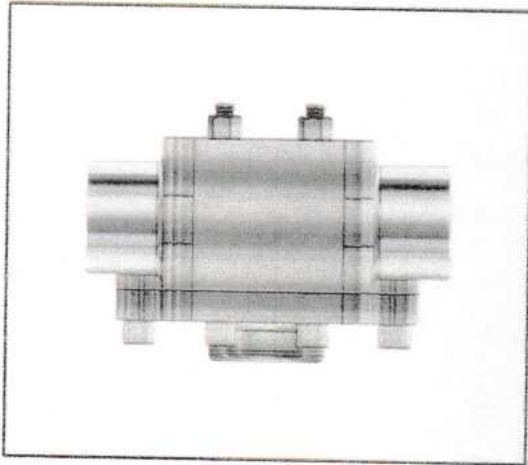

BOTTOM VIEW

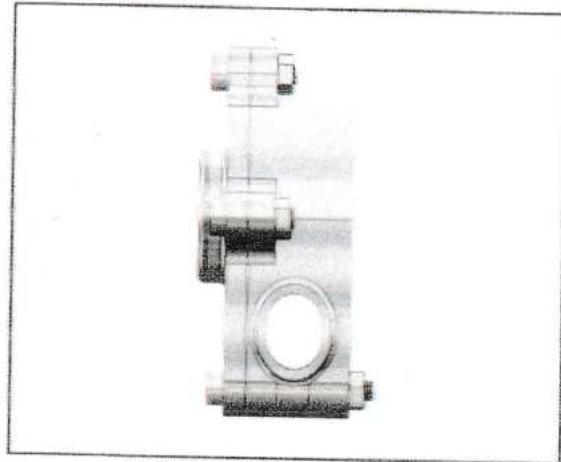

LEFT SIDE VIEW

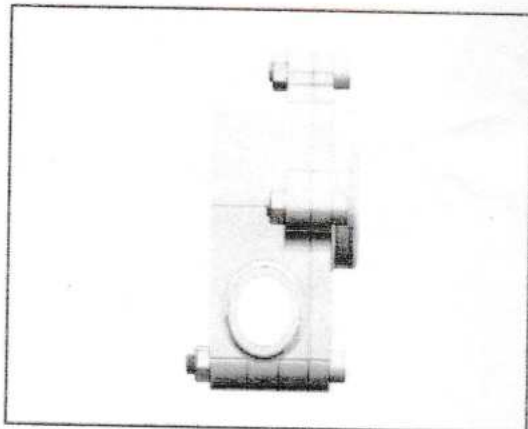

RIGHT SIDE VIEW

The novelty resides in the shape and configuration of the 'STEERING CASING' as illustrated.



A Steering casing is used in all-terrain vehicle for easy assembly and compact size.

No claim is made by virtue of this registration in respect of any mechanical or other action of the mechanism whatever or in respect of any mode or principle of construction of the article.

No claim is made by virtue of the registration to any right to the exclusive use of the words, letters, numbers, colour, combination or Trade Marks as appearing in the representation.

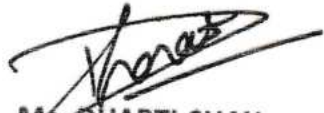
348965-001
06 SEP 2021

Ms. DHARTI SHAH
(Authorized Agent of the Applicant)
(IN/PA- 2590)

DESIGN NUMBER	348965-001	
CLASS	12-16	
1.VENISH SUTHAR, SILVER OAK UNIVERSITY CAMPUS, OPP. BHAGWAT VIDYAPITH, S.G ROAD, GOTA, AHMEDABAD - 382421 2. RUTVIK SUTHAR, SILVER OAK UNIVERSITY CAMPUS, OPP. BHAGWAT VIDYAPITH, S.G ROAD, GOTA, AHMEDABAD - 382421		
DATE OF REGISTRATION	06/09/2021	
TITLE	STEERING CASING	
PRIORITY NA		
DESIGN NUMBER	348986-001	
CLASS	07-01	
1.SACHI CHOUDHARY, UNIVERSITY OF PETROLEUM AND ENERGY STUDIES, ENERGY ACRES, BIDHOLI, VIA PREMNAGAR, DEHRADUN 248007, UTTARAKHAND INDIA 2. PRASHANT SHUKLA, UNIVERSITY OF PETROLEUM AND ENERGY STUDIES, ENERGY ACRES, BIDHOLI, VIA PREMNAGAR, DEHRADUN 248007, UTTARAKHAND INDIA		
DATE OF REGISTRATION	06/09/2021	
TITLE	BEVERAGE CUP WITH FILTER ARRANGEMENT	
PRIORITY NA		
DESIGN NUMBER	349000-001	
CLASS	03-03	
SHOBHIT INSTITUTE OF ENGINEERING AND TECHNOLOGY (DEEMED TO-BE UNIVERSITY), NH-58, DULHERA MARG, MODIPURAM, MEERUT-250110, UTTAR PRADESH, INDIA.		
DATE OF REGISTRATION	06/09/2021	
TITLE	WALKING STICK	
PRIORITY NA		



ORIGINAL

No. **104376**

भारत सरकार
GOVERNMENT OF INDIA
पेटेंट कार्यालय
THE PATENT OFFICE

CERTIFICATE OF REGISTRATION OF DESIGN

Design No. 349844-001
Date 20/09/2021 20:16:25
Reciprocity Date*
Country

Certified that the design of which a copy is annexed hereto has been registered as of the number and date given above in class 12-16 in respect of the application of such design to GEARBOX CASING in the name of 1.VENISH SUTHAR, SILVER OAK UNIVERSITY CAMPUS, OPP. BHAGWAT VIDYAPITH, S.G ROAD, GOTA, AHMEDABAD - 382421, INDIA, 2. MANISH JAYASAWAL, SILVER OAK UNIVERSITY CAMPUS, OPP. BHAGWAT VIDYAPITH, S.G ROAD, GOTA, AHMEDABAD - 382421, INDIA.

in pursuance of and subject to the provisions of the Designs Act, 2000 and the Designs Rules, 2001.

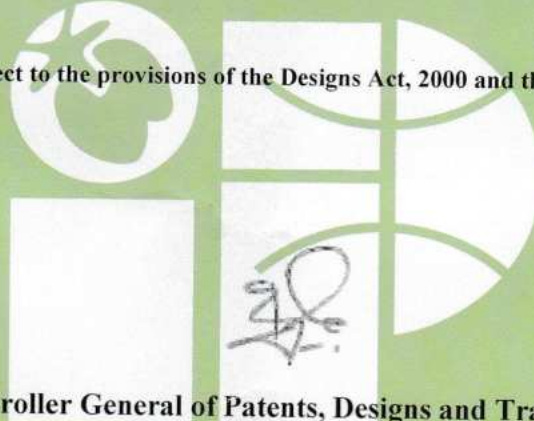

Controller General of Patents, Designs and Trade Marks

*The reciprocity date (if any) which has been allowed and the name of the country.

Copyright in the design will subsist for ten years from the date of Registration, and may under the terms of the Act and Rules, be extended for a further period of five years.

This Certificate is not for use in legal proceedings or for obtaining registration abroad

MS. DHARTI SHAH,
VERITE ASSOCIATES, 105, SCARLET GATEWAY, NR.
SPIPA ACADEMY, CORPORATE ROAD,
PRAHALADNAGR, AHMEDABAD-380015, GUJARAT,
INDIA

**INTELLECTUAL
PROPERTY INDIA**
DESIGNS | TRADE MARKS
GEOGRAPHICAL INDICATIONS

Date of Issue 08/11/2021 12:41:21

(REPRESENTATION SHEETS)

NAME OF THE APPLICANT
VENISH SUTHAR
MANISH JAYASAWAL

NO. OF SHEETS - 3
SHEET NO. - 1

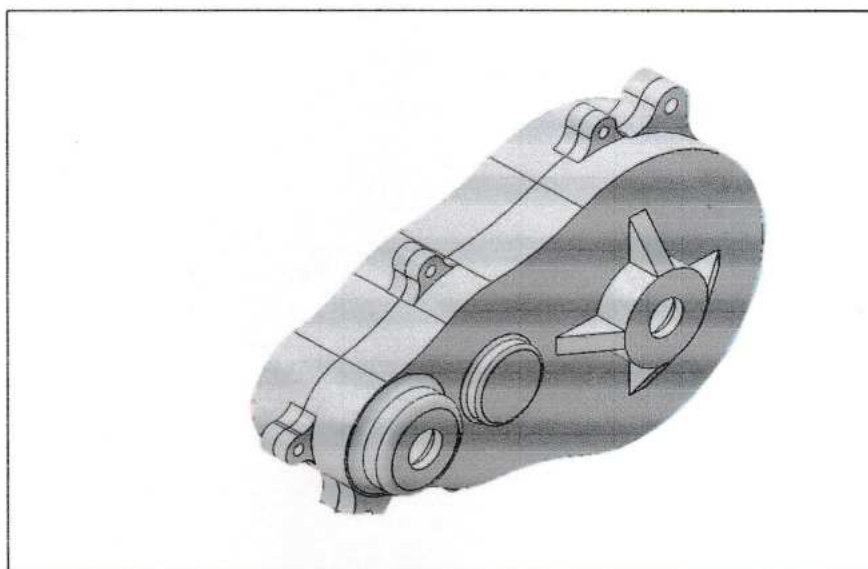

PERSPECTIVE VIEW

The novelty resides in the shape and configuration of the 'GEARBOX CASING' as illustrated.

~~A Gearbox Casing used as part of transmission for all-terrain vehicle to improve its performance.~~

No claim is made by virtue of this registration in respect of any mechanical or other action of the mechanism whatever or in respect of any mode or principle of construction of the article.

No claim is made by virtue of the registration to any right to the exclusive use of the words, letters, numbers, colour, combination or Trade Marks as appearing in the representation.

349844-001
20 SEP 2021

Ms. DHARTI SHAH
(Authorized Agent of the Applicant)
(IN/PA- 2590)

(REPRESENTATION SHEETS)

NAME OF THE APPLICANT
VENISH SUTHAR
MANISH JAYASAWAL

NO. OF SHEETS - 3
SHEET NO. - 2

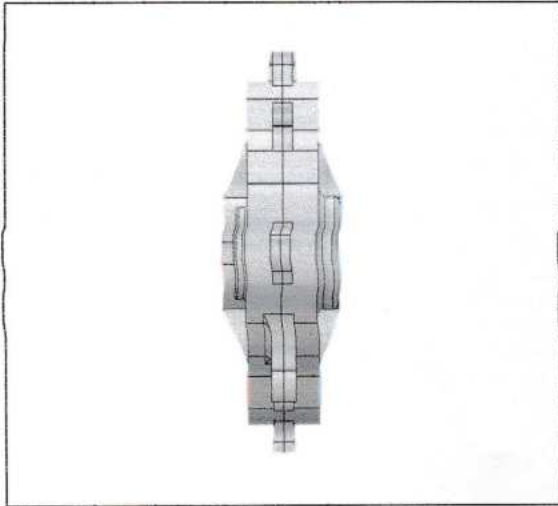

FRONT VIEW

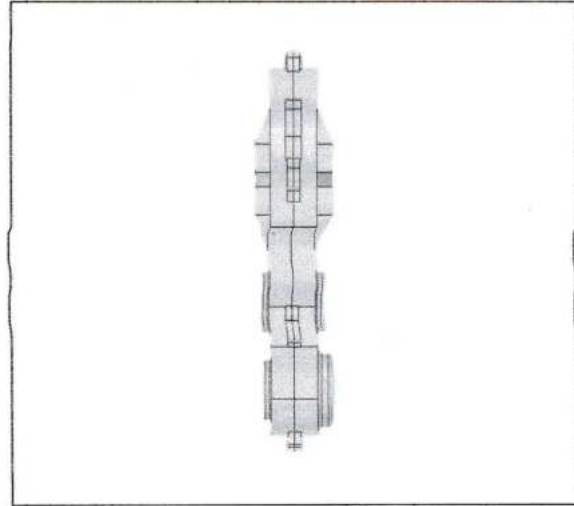

TOP VIEW

The novelty resides in the shape and configuration of the 'GEARBOX CASING' as illustrated.

~~A Gearbox Casing used as part of transmission for all terrain vehicle to improve its performance.~~

No claim is made by virtue of this registration in respect of any mechanical or other action of the mechanism whatever or in respect of any mode or principle of construction of the article.

No claim is made by virtue of the registration to any right to the exclusive use of the words, letters, numbers, colour, combination or Trade Marks as appearing in the representation.

349844-001

20 SEP 2021

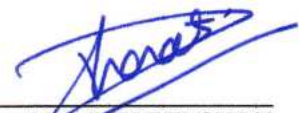

Ms. DHARTI SHAH
(Authorized Agent of the Applicant)
(IN/PA- 2590)

(REPRESENTATION SHEETS)

NAME OF THE APPLICANT

VENISH SUTHAR

MANISH JAYASAWAL

NO. OF SHEETS - 3

SHEET NO. - 3

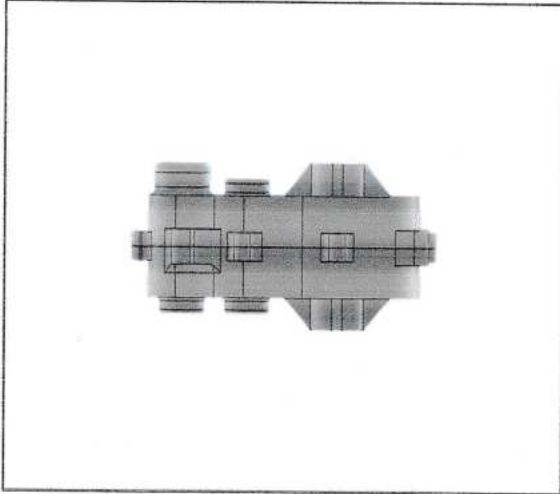

BOTTOM VIEW

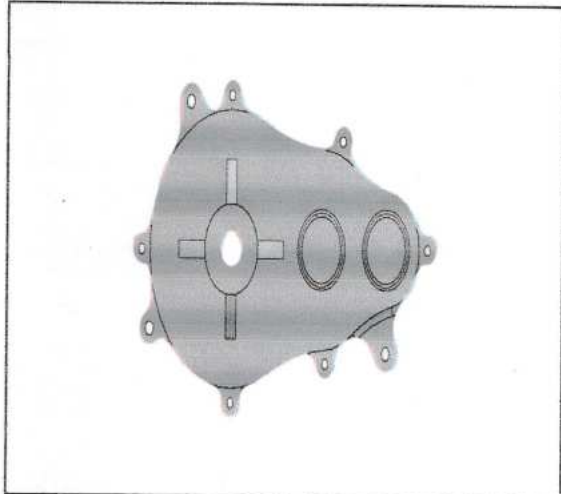

LEFT SIDE VIEW

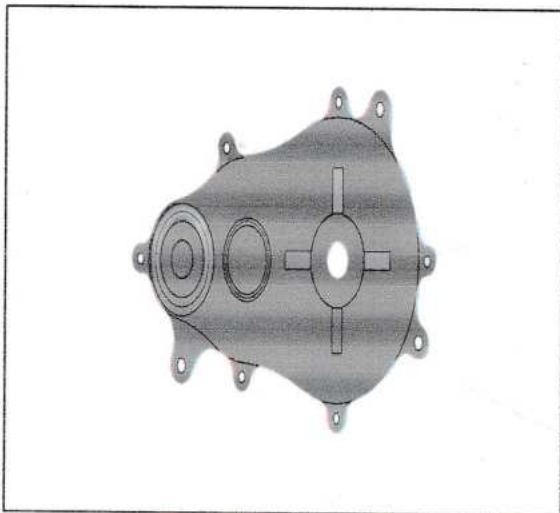

RIGHT SIDE VIEW

The novelty resides in the shape and configuration of the 'GEARBOX CASING' as illustrated.

~~A Gearbox Casing used as part of transmission for all-terrain vehicle to improve its performance.~~

No claim is made by virtue of this registration in respect of any mechanical or other action of the mechanism whatever or in respect of any mode or principle of construction of the article.

No claim is made by virtue of the registration to any right to the exclusive use of the words, letters, numbers, colour, combination or Trade Marks as appearing in the representation.

349844-001
20 SEP 2021

Ms. DHARTI SHAH
(Authorized Agent of the Applicant)
(IN/PA- 2590)

DESIGN NUMBER	349759-043	
CLASS	08-06	
QUBA ARCHITECTURAL PRODUCTS PVT. LTD., PLOT NO. 29-30, SURVEY NO. 33, VAVDI, GONDAL ROAD, DIST. RAJKOT-360004, GUJARAT - INDIA		
DATE OF REGISTRATION	20/09/2021	
TITLE	HANDLE	
PRIORITY NA		
DESIGN NUMBER	349838-001	
CLASS	14-06	
REVERGON SOLUTIONS PRIVATE LIMITED, A2, NILES CHS, PLOT NO. 22, SECTOR 14, VASHI NAVI MUMBAI - 400703		
DATE OF REGISTRATION	20/09/2021	
TITLE	MOBILE STAND	
PRIORITY NA		
DESIGN NUMBER	349844-001	
CLASS	12-16	
1. VENISH SUTHAR, SILVER OAK UNIVERSITY CAMPUS, OPP. BHAGWAT VIDYAPITH, S.G ROAD, GOTA, AHMEDABAD - 382421, INDIA, 2. MANISH JAYASAWAL, SILVER OAK UNIVERSITY CAMPUS, OPP. BHAGWAT VIDYAPITH, S.G ROAD, GOTA, AHMEDABAD - 382421, INDIA.		
DATE OF REGISTRATION	20/09/2021	
TITLE	GEARBOX CASING	
PRIORITY NA		



ORIGINAL

No. 104835

भारत सरकार
GOVERNMENT OF INDIA
पेटेंट कार्यालय
THE PATENT OFFICE

CERTIFICATE OF REGISTRATION OF DESIGN

Design No. 349854-001
Date 20/09/2021 20:16:25
Reciprocity Date*
Country

Certified that the design of which a copy is annexed hereto has been registered as of the number and date given above in class 12-16 in respect of the application of such design to FRONT KNUCKLE in the name of 1. ANIKET PATEL, SILVER OAK UNIVERSITY CAMPUS, OPP. BHAGWAT VIDYAPITH, S.G ROAD, GOTTA, AHMEDABAD - 382421, INDIA 2. VENISH SUTHAR, SILVER OAK UNIVERSITY CAMPUS, OPP. BHAGWAT VIDYAPITH, S.G ROAD, GOTTA, AHMEDABAD - 382421, INDIA

in pursuance of and subject to the provisions of the Designs Act, 2000 and the Designs Rules, 2001.

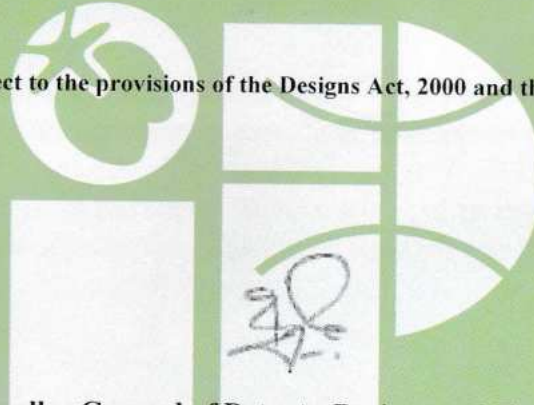

Controller General of Patents, Designs and Trade Marks

*The reciprocity date (if any) which has been allowed and the name of the country.

Copyright in the design will subsist for ten years from the date of Registration, and may under the terms of the Act and Rules, be extended for a further period of five years.

This Certificate is not for use in legal proceedings or for obtaining registration abroad

INTELLECTUAL
PROPERTY INDIA
DESIGNS | TRADE MARKS
INDICATIONS

MS. DHARTI SHAH,
VERITE ASSOCIATES, 105, SCARLET GATEWAY, NR.
SPIPA ACADEMY, CORPORATE ROAD,
PRAHALADNAGR, AHMEDABAD-380015, GUJARAT,
INDIA

Date of Issue 16/11/2021 15:03:50

(REPRESENTATION SHEETS)

NAME OF THE APPLICANT
VENISH SUTHAR
ANIKET PATEL

NO. OF SHEETS. - 3
SHEET NO. - 1

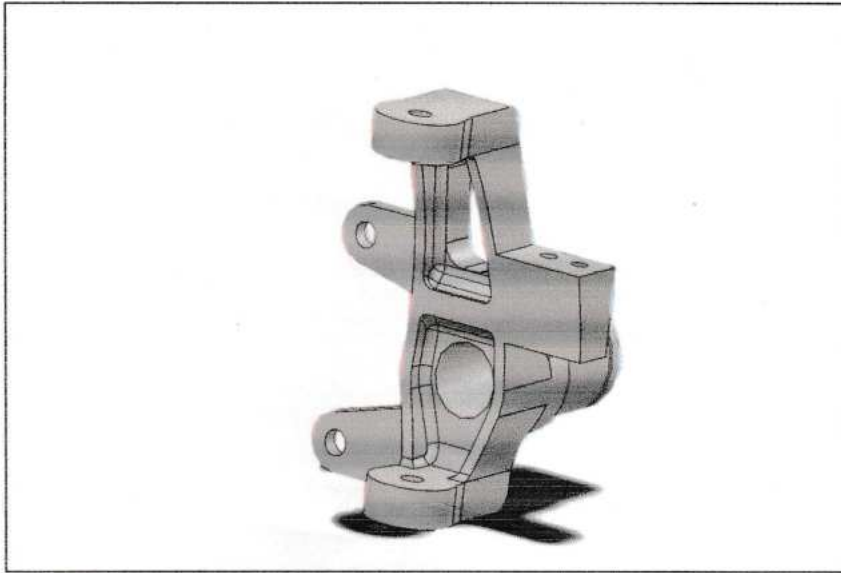

PERSPECTIVE VIEW

The novelty resides in the shape and configuration of the 'FRONT KNUCKLE' as illustrated.

~~A Front Knuckle is used in all-terrain vehicle to control suspension and steering with lighter material to improve its performance.~~

No claim is made by virtue of this registration in respect of any mechanical or other action of the mechanism whatever or in respect of any mode or principle of construction of the article.

No claim is made by virtue of the registration to any right to the exclusive use of the words, letters, numbers, colour, combination or Trade Marks as appearing in the representation.

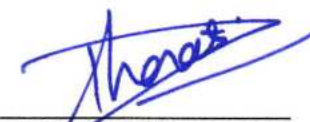

349854-001
20 SEP 2021

Ms. DHARTI SHAH
(Authorized Agent of the Applicant)
(IN/PA- 2590)

(REPRESENTATION SHEETS)

NAME OF THE APPLICANT
VENISH SUTHAR
ANIKET PATEL

NO. OF SHEETS. - 3
SHEET NO. - 2



FRONT VIEW

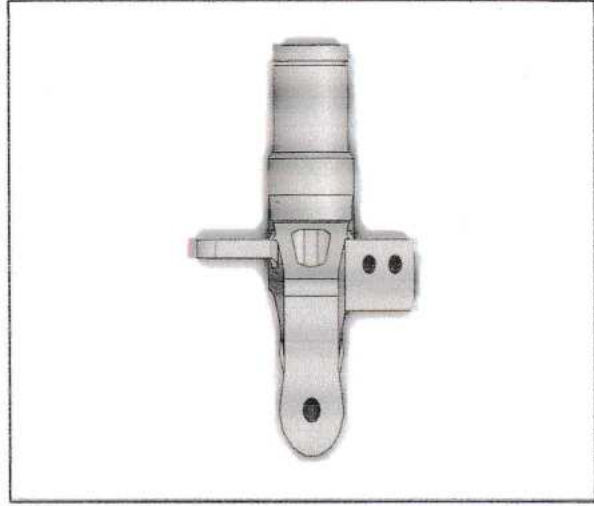

TOP VIEW

The novelty resides in the shape and configuration of the '**FRONT KNUCKLE**' as illustrated.

~~A Front Knuckle is used in all-terrain vehicle to control suspension and steering with lighter material to improve its performance.~~

No claim is made by virtue of this registration in respect of any mechanical or other action of the mechanism whatever or in respect of any mode or principle of construction of the article.

No claim is made by virtue of the registration to any right to the exclusive use of the words, letters, numbers, colour, combination or Trade Marks as appearing in the representation.

349854-001

20 SEP 2021

Ms. DHARTI SHAH
(Authorized Agent of the Applicant)
(IN/PA- 2590)

(REPRESENTATION SHEETS)

NAME OF THE APPLICANT
VENISH SUTHAR
ANIKET PATEL

NO. OF SHEETS. - 3
SHEET NO. - 3

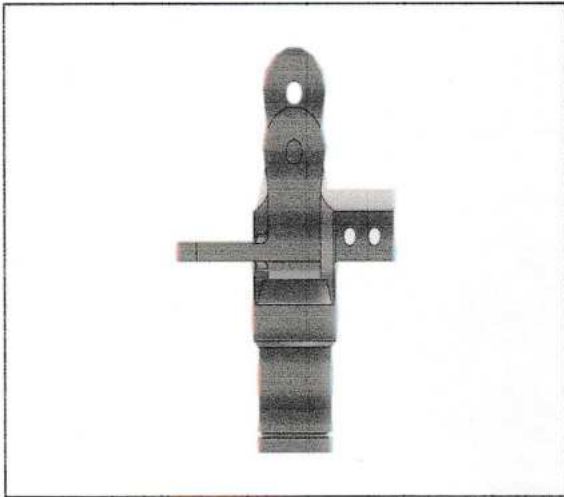

BOTTOM VIEW

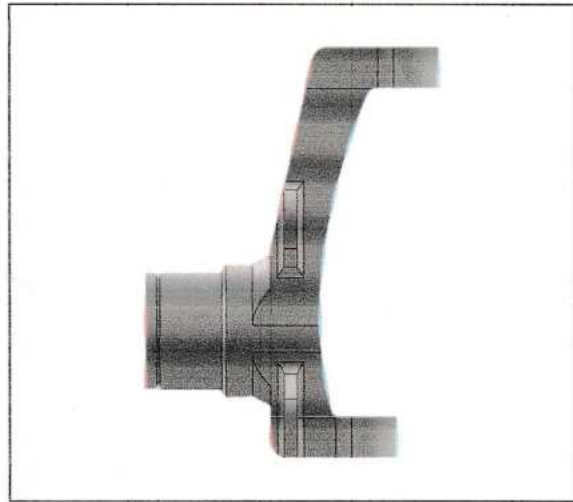

LEFT SIDE VIEW

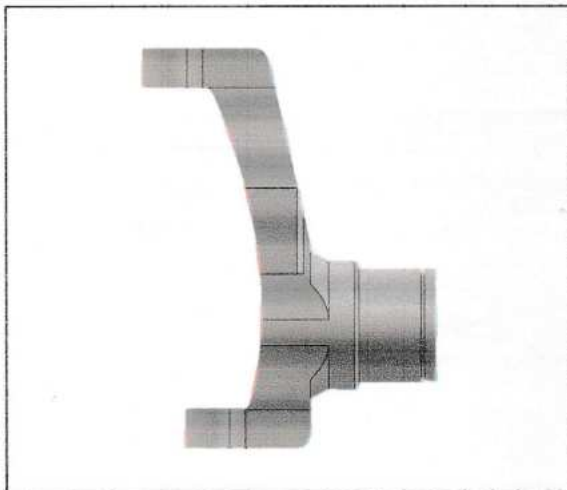

RIGHT SIDE VIEW

The novelty resides in the shape and configuration of the 'FRONT KNUCKLE' as illustrated.

~~A Front Knuckle is used in all-terrain vehicle to control suspension and steering with lighter material to improve its performance.~~

No claim is made by virtue of this registration in respect of any mechanical or other action of the mechanism whatever or in respect of any mode or principle of construction of the article.

No claim is made by virtue of the registration to any right to the exclusive use of the words, letters, numbers, colour, combination or Trade Marks as appearing in the representation.

349854-001
20 SEP 2021

Ms. DHARTI SHAH
(Authorized Agent of the Applicant)
(IN/PA- 2590)

DESIGN NUMBER	349846-001	
CLASS	12-16	
1.SUMIT GURBANI, SILVER OAK UNIVERSITY CAMPUS, OPP. BHAGWAT VIDYAPITH, S.G ROAD, GOTA, AHMEDABAD - 382421 2. MOHIT SINGH SILVER OAK UNIVERSITY CAMPUS, OPP. BHAGWAT VIDYAPITH, S.G ROAD, GOTA, AHMEDABAD - 382421		
DATE OF REGISTRATION	20/09/2021	
TITLE	REAR KNUCKLE	
PRIORITY NA		
DESIGN NUMBER	349854-001	
CLASS	12-16	
1.ANIKET PATEL, SILVER OAK UNIVERSITY CAMPUS, OPP. BHAGWAT VIDYAPITH, S.G ROAD, GOTA, AHMEDABAD – 382421, INDIA 2. VENISH SUTHAR, SILVER OAK UNIVERSITY CAMPUS, OPP. BHAGWAT VIDYAPITH, S.G ROAD, GOTA, AHMEDABAD – 382421, INDIA		
DATE OF REGISTRATION	20/09/2021	
TITLE	FRONT KNUCKLE	
PRIORITY NA		
DESIGN NUMBER	349877-008	
CLASS	26-02	
GOVIND SINGH PUROHIT KA WAS BHAWRANI, AHORE, JALORE, RAJASTHAN - 343042, INDIA		
DATE OF REGISTRATION	21/09/2021	
TITLE	TORCH	
PRIORITY NA		



सत्यमेव जयते

भारत सरकार
GOVERNMENT OF INDIA
पेटेंट कार्यालय
THE PATENT OFFICE

ORIGINAL

No. 106454

CERTIFICATE OF REGISTRATION OF DESIGN

Design No. 350646-001
Date 04/10/2021 19:51:10
Reciprocity Date*
Country

Certified that the design of which a copy is annexed hereto has been registered as of the number and date given above in class 12-16 in respect of the application of such design to REAR HUB INTEGRATED WITH CV in the name of I.BRIJESH VAGHELA, SILVER OAK UNIVERSITY CAMPUS, OPP. BHAGWAT VIDYAPITH, S.G ROAD, GOTA, AHMEDABAD - 382421 2. BHAVDEEP TRIVEDI, SILVER OAK UNIVERSITY CAMPUS, OPP. BHAGWAT VIDYAPITH, S.G ROAD, GOTA, AHMEDABAD - 382421

in pursuance of and subject to the provisions of the Designs Act, 2000 and the Designs Rules, 2001.

Controller General of Patents, Designs and Trade Marks

*The reciprocity date (if any) which has been allowed and the name of the country.

Copyright in the design will subsist for ten years from the date of Registration, and may under the terms of the Act and Rules, be extended for a further period of five years.

This Certificate is not for use in legal proceedings or for obtaining registration abroad

MS. DHARTI SHAH,
VERITE ASSOCIATES, 105, SCARLET GATEWAY, NR.
SPIPA ACADEMY, CORPORATE ROAD,
PRAHALADNAGR, AHMEDABAD-380015, GUJARAT,
INDIA

Date of Issue 22/12/2021 17:10:40

INTELLECTUAL
PROPERTY INDIA
PATENTS | DESIGNS | TRADE MARKS
GEOGRAPHICAL INDICATIONS

(REPRESENTATION SHEETS)

NAME OF THE APPLICANT
BRIJESH VAGHELA
BHAVDEEP TRIVEDI

NO. OF SHEETS - 3
SHEET NO. - 1



PERSPECTIVE VIEW

The novelty resides in the shape and configuration of the 'REAR HUB INTEGRATED WITH CV' as illustrated.

A Rear Hub integrated with CV is specially designed with two components in one assembly with lighter material for all terrain vehicles to improve its performance.

No claim is made by virtue of this registration in respect of any mechanical or other action of the mechanism whatever or in respect of any mode or principle of construction of the article.

No claim is made by virtue of the registration to any right to the exclusive use of the words, letters, numbers, colour, combination or Trade Marks as appearing in the representation.

350646-001

04 OCT 2021

Ms. DHARTI SHAH
(Authorized Agent of the Applicant)
(IN/PA- 2590)

(REPRESENTATION SHEETS)

NAME OF THE APPLICANT
BRIJESH VAGHELA
BHAVDEEP TRIVEDI

NO. OF SHEETS - 3
SHEET NO. - 2



FRONT VIEW

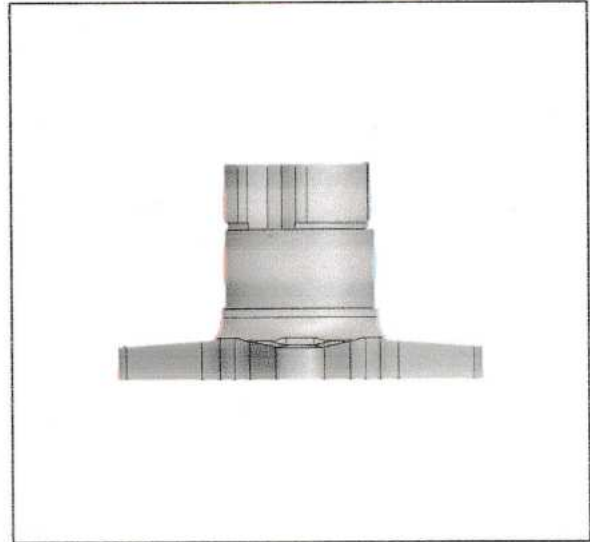

TOP VIEW

The novelty resides in the shape and configuration of the 'REAR HUB INTEGRATED WITH CV' as illustrated.

A Rear Hub integrated with CV is specially designed with two components in one assembly with lighter material for all terrain vehicles to improve its performance.

No claim is made by virtue of this registration in respect of any mechanical or other action of the mechanism whatever or in respect of any mode or principle of construction of the article.

No claim is made by virtue of the registration to any right to the exclusive use of the words, letters, numbers, colour, combination or Trade Marks as appearing in the representation.

350646 -001

04 OCT 2021

Ms. DHARTI SHAH
(Authorized Agent of the Applicant)
(IN/PA- 2590)

(REPRESENTATION SHEETS)

NAME OF THE APPLICANT
BRIJESH VAGHELA
BHAVDEEP TRIVEDI

NO. OF SHEETS - 3
SHEET NO. - 3



BOTTOM VIEW



LEFT SIDE VIEW

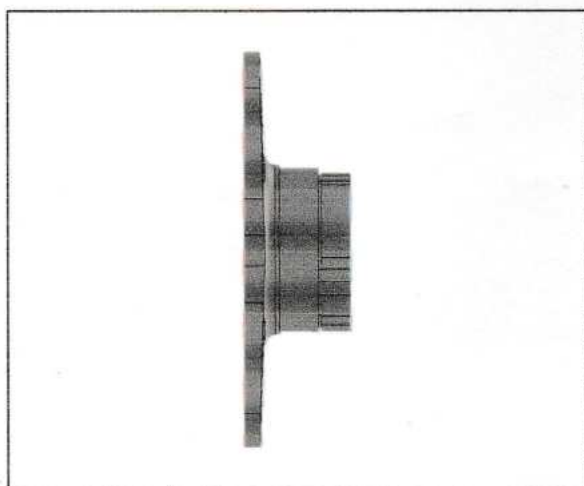

RIGHT SIDE VIEW

The novelty resides in the shape and configuration of the 'REAR HUB INTEGRATED WITH CV' as illustrated.

A Rear Hub integrated with CV is specially designed with two components in one assembly with lighter material for all terrain vehicles to improve its performance.



No claim is made by virtue of this registration in respect of any mechanical or other action of the mechanism whatever or in respect of any mode or principle of construction of the article.

No claim is made by virtue of the registration to any right to the exclusive use of the words, letters, numbers, colour, combination or Trade Marks as appearing in the representation.

350646 -001

04 OCT 2021

Ms. DHARTI SHAH
(Authorized Agent of the Applicant)
(IN/PA- 2590)

DESIGN NUMBER	350597-001	
CLASS	02-02	
MAHIPATSINH NARSHANGBHAI CHAUHAN, A-1/303, SUKHDEV RESIDENCY, NR. UTRAN RAILWAY STATION, UTRAN, SURAT-394105.		
DATE OF REGISTRATION	04/10/2021	
TITLE	SAREE AND BLOUSE (SET)	
PRIORITY NA		
DESIGN NUMBER	350623-002	
CLASS	10-02	
NEHAL AJAY SHIROYA, 2ND FLOOR, 74, SARASWATI NAGAR SOCIETY, SARTHANA JAKATNAKA, SURAT-395006, INDIA		
DATE OF REGISTRATION	04/10/2021	
TITLE	WRIST WATCH	
PRIORITY NA		
DESIGN NUMBER	350646-001	
CLASS	12-16	
1. BRIJESH VAGHELA, SILVER OAK UNIVERSITY CAMPUS, OPP. BHAGWAT VIDYAPITH, S.G ROAD, GOTA, AHMEDABAD – 382421 2. BHAVDEEP TRIVEDI, SILVER OAK UNIVERSITY CAMPUS, OPP. BHAGWAT VIDYAPITH, S.G ROAD, GOTA, AHMEDABAD – 382421		
DATE OF REGISTRATION	04/10/2021	
TITLE	REAR HUB INTEGRATED WITH CV	
PRIORITY NA		



ORIGINAL

No. 105140

भारत सरकार
GOVERNMENT OF INDIA
पेटेंट कार्यालय
THE PATENT OFFICE

CERTIFICATE OF REGISTRATION OF DESIGN

Design No. 350653-001
Date 04/10/2021 19:51:10
Reciprocity Date*
Country

Certified that the design of which a copy is annexed hereto has been registered as of the number and date given above in class 12-16 in respect of the application of such design to FRONT KNUCKLE in the name of 1.SAMARTH ADESARA, SILVER OAK UNIVERSITY CAMPUS, OPP. BHAGWAT VIDYAPITH, S.G ROAD, GOTA, AHMEDABAD – 382421 2. BHAVDEEP TRIVEDI, SILVER OAK UNIVERSITY CAMPUS, OPP. BHAGWAT VIDYAPITH, S.G ROAD, GOTA, AHMEDABAD – 382421

in pursuance of and subject to the provisions of the Designs Act, 2000 and the Designs Rules, 2001.

Controller General of Patents, Designs and Trade Marks

*The reciprocity date (if any) which has been allowed and the name of the country.

Copyright in the design will subsist for ten years from the date of Registration, and may under the terms of the Act and Rules, be extended for a further period of five years.

This Certificate is not for use in legal proceedings or for obtaining registration abroad

MS. DHARTI SHAH,
VERITE ASSOCIATES, 105, SCARLET GATEWAY, NR.
SPIPA ACADEMY, CORPORATE ROAD,
PRAHALADNAGR, AHMEDABAD-380015, GUJARAT,
INDIA

Date of Issue 23/11/2021 15:41:00

INTELLECTUAL
PROPERTY INDIA
PATENTS | DESIGNS | TRADE MARKS
GEOGRAPHICAL INDICATIONS

(REPRESENTATION SHEETS)

NAME OF THE APPLICANT
SAMARTH ADESARA
BHAVDEEP TRIVEDI

NO. OF SHEETS. - 3
SHEET NO. - 1

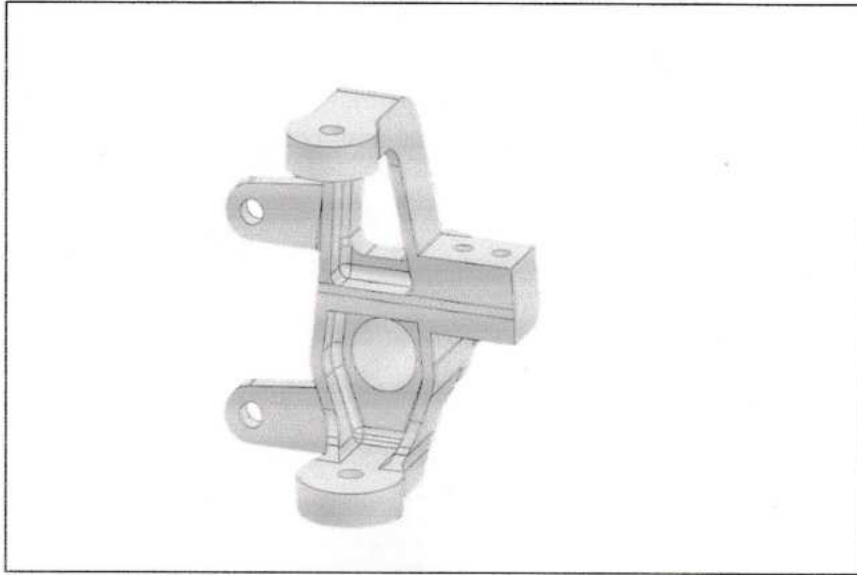

PERSPECTIVE VIEW

The novelty resides in the shape and configuration of the 'FRONT KNUCKLE' as illustrated.

~~A Front Knuckle is used in all-terrain vehicle to control suspension and steering with lighter material to improve its performance.~~

No claim is made by virtue of this registration in respect of any mechanical or other action of the mechanism whatever or in respect of any mode or principle of construction of the article.

No claim is made by virtue of the registration to any right to the exclusive use of the words, letters, numbers, colour, combination or Trade Marks as appearing in the representation.

350653-001
04 OCT 2021

Ms. DHARTI SHAH
(Authorized Agent of the Applicant)
(IN/PA- 2590)

(REPRESENTATION SHEETS)

NAME OF THE APPLICANT
SAMARTH ADESARA
BHAVDEEP TRIVEDI

NO. OF SHEETS. - 3
SHEET NO. - 2

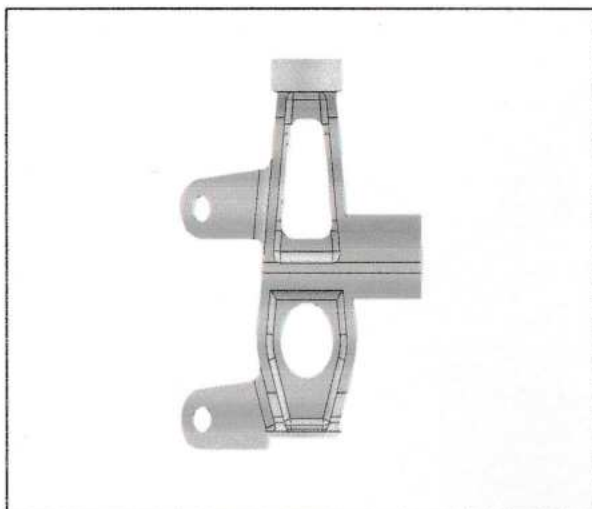

FRONT VIEW



TOP VIEW

The novelty resides in the shape and configuration of the 'FRONT KNUCKLE' as illustrated.

~~A Front Knuckle is used in all-terrain vehicle to control suspension and steering with lighter material to improve its performance.~~

No claim is made by virtue of this registration in respect of any mechanical or other action of the mechanism whatever or in respect of any mode or principle of construction of the article.

No claim is made by virtue of the registration to any right to the exclusive use of the words, letters, numbers, colour, combination or Trade Marks as appearing in the representation.

350653-001

04 OCT 2021

Ms. DHARTI SHAH
(Authorized Agent of the Applicant)
(IN/PA- 2590)

(REPRESENTATION SHEETS)

NAME OF THE APPLICANT
SAMARTH ADESARA
BHAVDEEP TRIVEDI

NO. OF SHEETS. - 3
SHEET NO. - 3

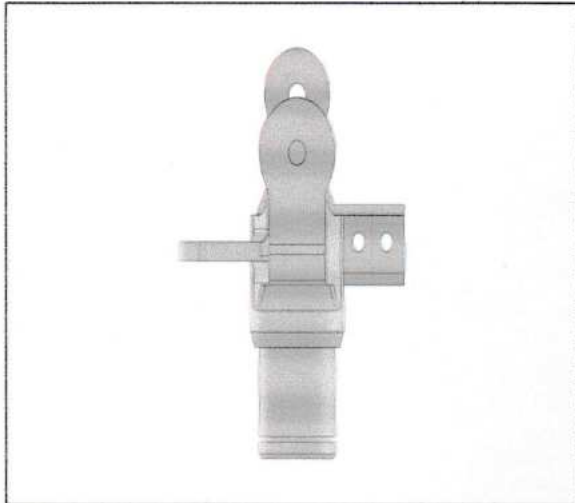

BOTTOM VIEW

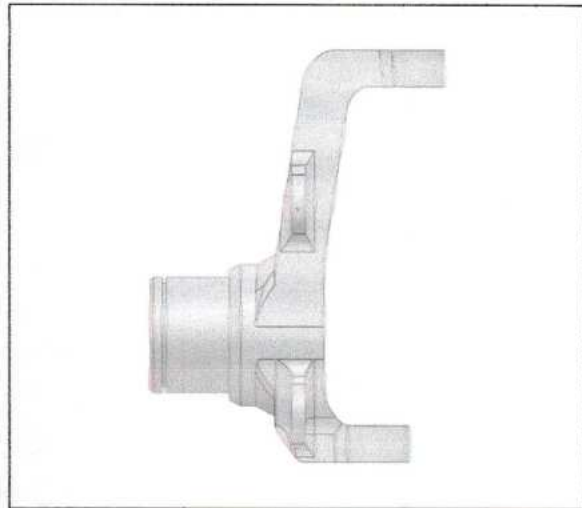

LEFT SIDE VIEW

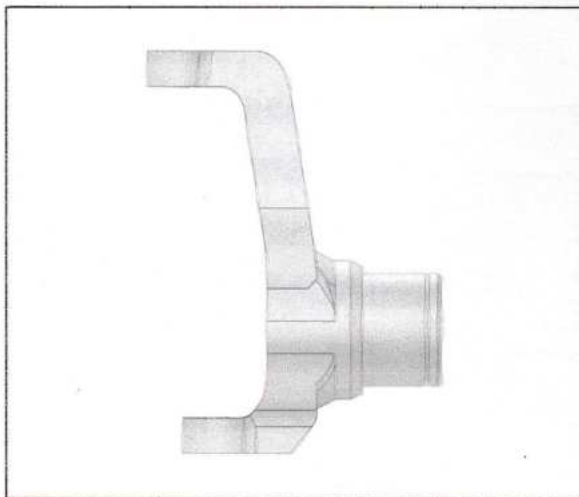

RIGHT SIDE VIEW

The novelty resides in the shape and configuration of the 'FRONT KNUCKLE' as illustrated.

A Front Knuckle is used in all-terrain vehicle to control suspension and steering with lighter material to improve its performance.



No claim is made by virtue of this registration in respect of any mechanical or other action of the mechanism whatever or in respect of any mode or principle of construction of the article.

No claim is made by virtue of the registration to any right to the exclusive use of the words, letters, numbers, colour, combination or Trade Marks as appearing in the representation.

350653-001

04 OCT 2021

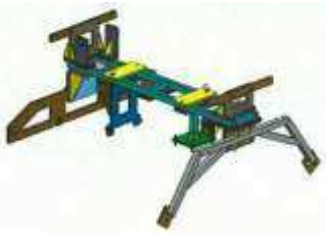
Ms. DHARTI SHAH
(Authorized Agent of the Applicant)
(IN/PA- 2590)

DESIGN NUMBER	350617-001		
CLASS	23-01		
HANSGROHE SE, AUESTR. 5-9, 77761 SCHILTACH, GERMANY			
DATE OF REGISTRATION	04/10/2021		
TITLE	FAUCET		
PRIORITY			
PRIORITY NUMBER	DATE	COUNTRY	
008489942-0001	08/04/2021	EUIPO	
DESIGN NUMBER	350627-002		
CLASS	08-05		
HINDUSTAN AERONAUTICS LIMITED, HELICOPTER DIVISION, VIMANAPURA POST, P.B. NO. - 1790, BENGALURU, KARNATAKA, INDIA - 560017 (PUBLIC SECTOR UNDERTAKING UNDER MINISTRY OF DEFENCE), GOVERNMENT OF INDIA			
DATE OF REGISTRATION	04/10/2021		
TITLE	SPECIAL FIXTURE FOR INSTALLATION OF FIREWALLS ON HELICOPTER		
PRIORITY NA			
DESIGN NUMBER	350653-001		
CLASS	12-16		
1.SAMARTH ADESARA, SILVER OAK UNIVERSITY CAMPUS, OPP. BHAGWAT VIDYAPITH, S.G ROAD, GOTA, AHMEDABAD – 382421 2. BHAVDEEP TRIVEDI, SILVER OAK UNIVERSITY CAMPUS, OPP. BHAGWAT VIDYAPITH, S.G ROAD, GOTA, AHMEDABAD – 382421			
DATE OF REGISTRATION	04/10/2021		
TITLE	FRONT KNUCKLE		
PRIORITY NA			



सत्यमेव जयते

ORIGINAL

No. 110986

भारत सरकार
GOVERNMENT OF INDIA
पेटेंट कार्यालय
THE PATENT OFFICE

CERTIFICATE OF REGISTRATION OF DESIGN

Design No. 356213-001
Date 05/01/2022 19:34:59
Reciprocity Date*
Country

Certified that the design of which a copy is annexed hereto has been registered as of the number and date given above in class 09-08 in respect of the application of such design to PALLET in the name of I. VEDKUMAR NARESHBHAI PATEL, SILVER OAK UNIVERSITY CAMPUS, OPP. BHAGWAT VIDYAPITH, S.G ROAD, GOTA, AHMEDABAD - 382481, INDIA 2. DHRUVKUMAR RAMESHBHAI PATEL, SILVER OAK UNIVERSITY CAMPUS, OPP. BHAGWAT VIDYAPITH, S.G ROAD, GOTA, AHMEDABAD - 382481, INDIA

in pursuance of and subject to the provisions of the Designs Act, 2000 and the Designs Rules, 2001.

Controller General of Patents, Designs and Trade Marks

*The reciprocity date (if any) which has been allowed and the name of the country.

Copyright in the design will subsist for ten years from the date of Registration, and may under the terms of the Act and Rules, be extended for a further period of five years.

This Certificate is not for use in legal proceedings or for obtaining registration abroad

MS. DHARTI SHAH,
VERITE ASSOCIATES, 105, SCARLET GATEWAY,
NR. SPIPA ACADEMY, CORPORATE ROAD,
PRAHALADNAGR, AHMEDABAD-380015,
GUJARAT, INDIA

Date of Issue 31/03/2022 11:38:52

(REPRESENTATION SHEETS)

NAME OF THE APPLICANT
VEDKUMAR NARESHBHAI PATEL
DHRUVKUMAR RAMESHBHAI PATEL

NO. OF SHEETS - 3
SHEET NO. - 1

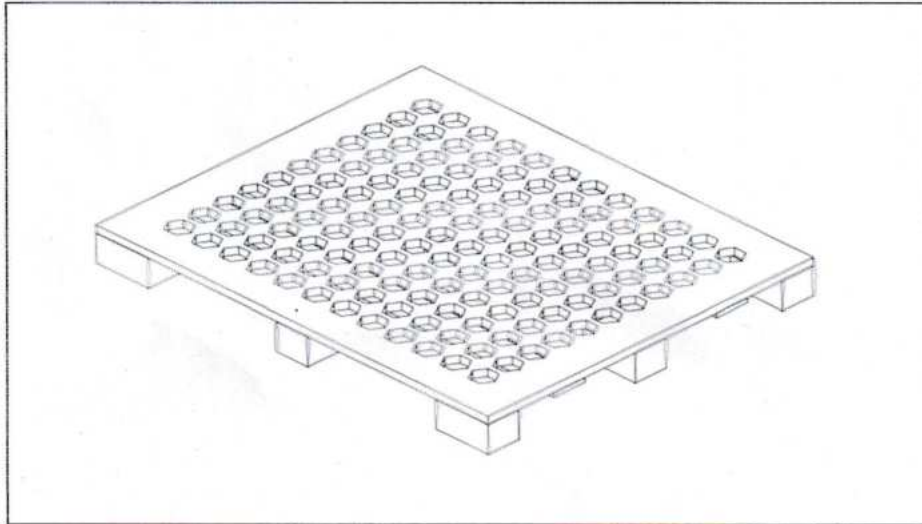

PERSPECTIVE VIEW

The novelty resides in the shape and configuration of the ~~'MODIFIED PALLET'~~ as illustrated.

No claim is made by virtue of this registration in respect of any mechanical or other action of the mechanism whatever or in respect of any mode or principle of construction of the article.

No claim is made by virtue of the registration to any right to the exclusive use of the words, letters, numbers, colour, combination or Trade Marks as appearing in the representation.

356213-001

05 JAN 2022

Ms. DHARTI SHAH
(Authorized Agent of the Applicant)
(IN/PA- 2590)

Dated this 5th Day of January 2022.

(REPRESENTATION SHEETS)

NAME OF THE APPLICANT
VEDKUMAR NARESHBHAI PATEL
DHARUVKUMAR RAMESHBHAI PATEL

NO. OF SHEETS - 3
SHEET NO. - 2

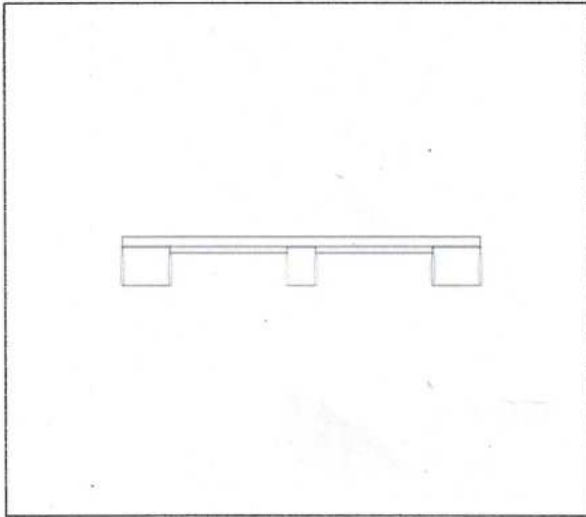

FRONT VIEW

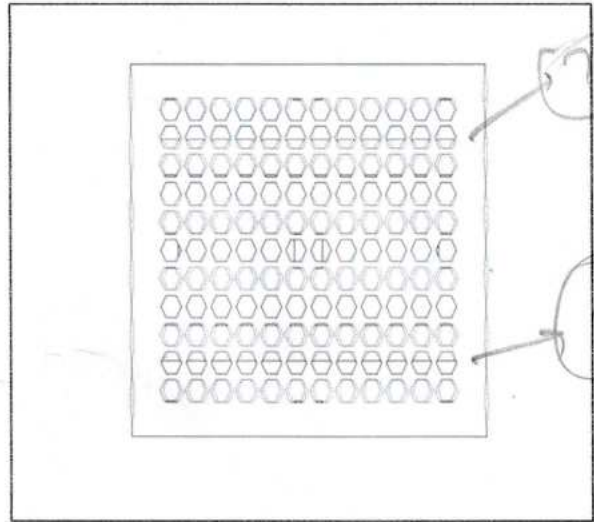

TOP VIEW

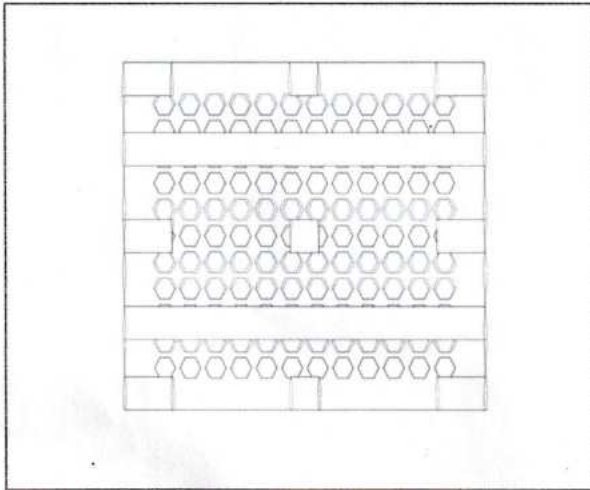

BOTTOM VIEW

The novelty resides in the shape and configuration of the **'MODIFIED PALLET'** as illustrated.

No claim is made by virtue of this registration in respect of any mechanical or other action of the mechanism whatever or in respect of any mode or principle of construction of the article.

No claim is made by virtue of the registration to any right to the exclusive use of the words, letters, numbers, colour, combination or Trade Marks as appearing in the representation.

356213-001

05 JAN 2022

Dated this 5th Day of January 2022.

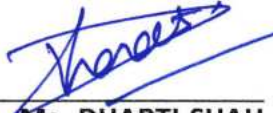
Ms. DHARTI SHAH
(Authorized Agent of the Applicant)
(IN/PA- 2590)

(REPRESENTATION SHEETS)

NAME OF THE APPLICANT
VEDKUMAR NARESHBHAI PATEL
DHRUVKUMAR RAMESHBHAI PATEL

NO. OF SHEETS - 3
SHEET NO. - 3



LEFT SIDE VIEW

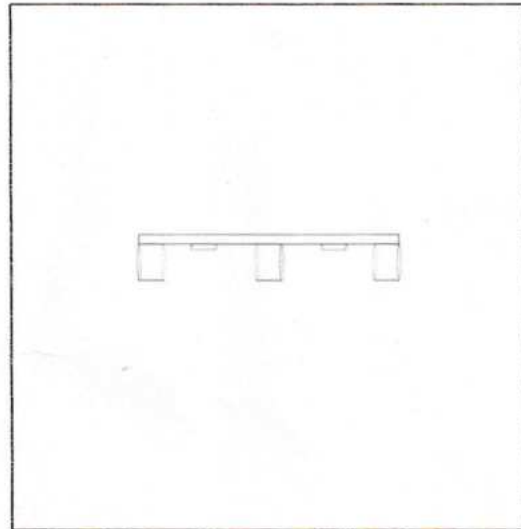

RIGHT SIDE VIEW

The novelty resides in the shape and configuration of the '**MODIFIED PALLET**' as illustrated.

No claim is made by virtue of this registration in respect of any mechanical or other action of the mechanism whatever or in respect of any mode or principle of construction of the article.



No claim is made by virtue of the registration to any right to the exclusive use of the words, letters, numbers, colour, combination or Trade Marks as appearing in the representation.

356213-001

05 JAN 2022

Dated this 5th Day of January 2022.

Ms. DHARTI SHAH
(Authorized Agent of the Applicant)
(IN/PA- 2590)

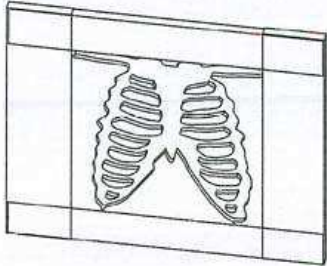
DESIGN NUMBER	356200-001		
CLASS	09-05		
THE GILLETTE COMPANY LLC ONE GILLETTE PARK, BOSTON, MASSACHUSETTS 02127, UNITED STATES OF AMERICA			
DATE OF REGISTRATION	05/01/2022		
TITLE	SHAVING RAZOR PACKAGE		
PRIORITY			
PRIORITY NUMBER	DATE	COUNTRY	
29/799608	15/07/2021	U.S.A.	
DESIGN NUMBER	356213-001		
CLASS	09-08		
1. VEDKUMAR NARESHBHAI PATEL SILVER OAK UNIVERSITY CAMPUS, OPP. BHAGWAT VIDYAPITH, S.G ROAD, GOTA, AHMEDABAD – 382481, INDIA 2. DHRUVKUMAR RAMESHBHAI PATEL SILVER OAK UNIVERSITY CAMPUS, OPP. BHAGWAT VIDYAPITH, S.G ROAD, GOTA, AHMEDABAD – 382481, INDIA			
DATE OF REGISTRATION	05/01/2022		
TITLE	PALLET		
PRIORITY NA			
DESIGN NUMBER	356270-001		
CLASS	24-02		
NITABEN NATVAR BHAI GAJJAR J3, KALPTARU FLATS, OPP. GANESH VIDHYALAYA, NAVAVADAJ, AHMEDABAD-380013, INDIA			
DATE OF REGISTRATION	06/01/2022		
TITLE	X RAY MACHINE SLIT FOR CHEST X RAY		
PRIORITY NA			



ORIGINAL

No. 104837

भारत सरकार
GOVERNMENT OF INDIA
पेटेंट कार्यालय
THE PATENT OFFICE

CERTIFICATE OF REGISTRATION OF DESIGN

Design No. 349846-001
Date 20/09/2021 20:16:25
Reciprocity Date*
Country

Certified that the design of which a copy is annexed hereto has been registered as of the number and date given above in class 12-16 in respect of the application of such design to REAR KNUCKLE in the name of 1.SUMIT GURBANI, SILVER OAK UNIVERSITY CAMPUS, OPP. BHAGWAT VIDYAPITH, S.G ROAD, GOTTA, AHMEDABAD - 382421 2. MOHIT SINGH SILVER OAK UNIVERSITY CAMPUS, OPP. BHAGWAT VIDYAPITH, S.G ROAD, GOTTA, AHMEDABAD - 382421

in pursuance of and subject to the provisions of the Designs Act, 2000 and the Designs Rules, 2001.

Controller General of Patents, Designs and Trade Marks

*The reciprocity date (if any) which has been allowed and the name of the country.

Copyright in the design will subsist for ten years from the date of Registration, and may under the terms of the Act and Rules, be extended for a further period of five years.

This Certificate is not for use in legal proceedings or for obtaining registration abroad

MS. DHARTI SHAH,
VERITE ASSOCIATES, 105, SCARLET GATEWAY, NR.
SPIPA ACADEMY, CORPORATE ROAD,
PRAHALADNAGR, AHMEDABAD-380015, GUJARAT,
INDIA

Date of Issue 16/11/2021 15:05:05

INTELLECTUAL
PROPERTY INDIA
PATENTS | DESIGNS | TRADE MARKS
GEOGRAPHICAL INDICATIONS

DESIGN NUMBER	349846-001	
CLASS	12-16	
1.SUMIT GURBANI, SILVER OAK UNIVERSITY CAMPUS, OPP. BHAGWAT VIDYAPITH, S.G ROAD, GOTA, AHMEDABAD - 382421 2. MOHIT SINGH SILVER OAK UNIVERSITY CAMPUS, OPP. BHAGWAT VIDYAPITH, S.G ROAD, GOTA, AHMEDABAD - 382421		
DATE OF REGISTRATION	20/09/2021	
TITLE	REAR KNUCKLE	
PRIORITY NA		
DESIGN NUMBER	349854-001	
CLASS	12-16	
1.ANIKET PATEL, SILVER OAK UNIVERSITY CAMPUS, OPP. BHAGWAT VIDYAPITH, S.G ROAD, GOTA, AHMEDABAD – 382421, INDIA 2. VENISH SUTHAR, SILVER OAK UNIVERSITY CAMPUS, OPP. BHAGWAT VIDYAPITH, S.G ROAD, GOTA, AHMEDABAD – 382421, INDIA		
DATE OF REGISTRATION	20/09/2021	
TITLE	FRONT KNUCKLE	
PRIORITY NA		
DESIGN NUMBER	349877-008	
CLASS	26-02	
GOVIND SINGH PUROHIT KA WAS BHAWRANI, AHORE, JALORE, RAJASTHAN - 343042, INDIA		
DATE OF REGISTRATION	21/09/2021	
TITLE	TORCH	
PRIORITY NA		



ORIGINAL

No. 103961

भारत सरकार
GOVERNMENT OF INDIA
पेटेंट कार्यालय
THE PATENT OFFICE

CERTIFICATE OF REGISTRATION OF DESIGN

Design No. 348963-001
Date 06/09/2021 17:02:25
Reciprocity Date*
Country

Certified that the design of which a copy is annexed hereto has been registered as of the number and date given above in class 12-16 in respect of the application of such design to GEARBOX CASING in the name of 1.KARTIK IYER, SILVER OAK UNIVERSITY CAMPUS, OPP. BHAGWAT VIDYAPITH, S.G ROAD, GOTA, AHMEDABAD - 382421 2. KRUNAL KERALIYA, SILVER OAK UNIVERSITY CAMPUS, OPP. BHAGWAT VIDYAPITH, S.G ROAD, GOTA, AHMEDABAD - 382421

in pursuance of and subject to the provisions of the Designs Act, 2000 and the Designs Rules, 2001.

Controller General of Patents, Designs and Trade Marks

*The reciprocity date (if any) which has been allowed and the name of the country.



Copyright in the design will subsist for ten years from the date of Registration, and may under the terms of the Act and Rules, be extended for a further period of five years.

This Certificate is not for use in legal proceedings or for obtaining registration abroad

MS. DHARTI SHAH,
VERITE ASSOCIATES, 105, SCARLET GATEWAY,
NR.SPIPA ACADEMY, CORPORATE ROAD,
PRAHALADNAGR, AHMEDABAD-380015, GUJARAT,
INDIA

Date of Issue 28/10/2021 11:36:54

INTELLECTUAL
PROPERTY INDIA
PATENTS | DESIGNS | TRADE MARKS
GEOGRAPHICAL INDICATIONS

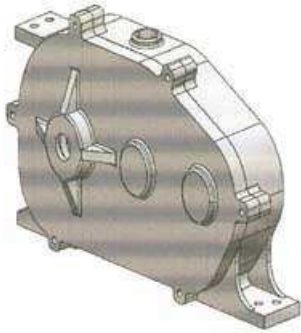
DESIGN NUMBER	338276-002	
CLASS	03-01	
ASMITABEN TUSHARBHAI SABALPARA, TO AMRELI SYAMJI NAGAR LATHI ROAD, BH BANK OF BARODA AMRELI -365601 GUJARAT, INDIA		
DATE OF REGISTRATION	29/01/2021	
TITLE	BAG	
PRIORITY NA		
DESIGN NUMBER	338276-010	
CLASS	03-01	
ASMITABEN TUSHARBHAI SABALPARA, AMRELI SYAMJI NAGAR LATHI ROAD, BH BANK OF BARODA AMRELI -365601 GUJARAT, INDIA		
DATE OF REGISTRATION	29/01/2021	
TITLE	BAG	
PRIORITY NA		
DESIGN NUMBER	348963-001	
CLASS	12-16	
1. KARTIK IYER, SILVER OAK UNIVERSITY CAMPUS, OPP. BHAGWAT VIDYAPITH, S.G ROAD, GOTA, AHMEDABAD - 382421 2. KRUNAL KERALIYA, SILVER OAK UNIVERSITY CAMPUS, OPP. BHAGWAT VIDYAPITH, S.G ROAD, GOTA, AHMEDABAD - 382421		
DATE OF REGISTRATION	06/09/2021	
TITLE	GEARBOX CASING	
PRIORITY NA		